

**SMART –
Strategies to Promote Small Scale
Hydro Electricity Production in Europe**

Deliverable D3.1

**Policies, Methodologies & Tools
to Improve the Exploitation of
Small Hydro Power Plants**





Policies, Methodologies & Tools to Improve the Exploitation of SHP

DISCLAIMER

The project SMART (Strategies to promote small scale hydro electricity production in Europe) is supported by the “Intelligent Energy – Europe” Programme (Contract N°: EIE-07-064).

The sole responsibility for the content of this report lies with the authors. It does not represent the opinion of the Community. The European Commission is not responsible for any use that may be made of the information contained therein.

AUTHORS:

Province of Cremona (Italy)	Marco Antoniazzi
Province of Attica (Greece)	Lilly Christoforidou
Thaya County (Austria)	Otmar Schlager Thomas Waldhans
NTNU (Norway)	Anna Carmen Masoliver Verdaguer Sølvi Eide Idun Schjerven Østgård Ole Gunnar Dahlhaug
FSBUZ (Croatia)	Zvonimir Guzović Branimir Matijašević
Karlovac County (Croatia)	Marinko Maradin
ERSE (Italy)	Julio Alterach Giuseppe Stella Stefano Maran Maximo Peviani



Policies, Methodologies & Tools to Improve the Exploitation of SHP

Table of contents

1 Introduction

2 Policies, Methodologies and Best Practice

2.1 Province of Cremona, Italy

Summary

2.1.1 The Development Pact

2.1.1.2 Definition

2.1.1.2 The course of the project

2.1.1.3 Means of implementation

2.1.1.4 The Pact and the young

2.1.2 The Environmental Energy Plan

2.1.2.1 Introduction

2.1.2.2 PEAP structure

2.1.2.2.1 Part One: General Fact-Finding Framework

2.1.2.2.2 Part Two – Analysis of the energy system:

2.1.2.2.3 Part Three – Assessment of feasibility and effectiveness of actions

2.1.2.2.4 Part Four –Target scenarios

2.1.2.2.5 Part Five – Management tools

2.1.2.3 Meetings and works that led to the drawing up of the energy plan

2.1.2.4 Actions undertaken

2.1.2.4.1 A) Mini Hydro Power

2.1.2.4.2 B) Energy Exploitation of Biomasses And Biogas

2.1.2.4.3 C) Energy Saving in Public and Private Buildings

2.1.2.4.4 D) Promotion of Photovoltaic Power

2.1.2.4.5 E) Setting up a Provincial Office for the Public

2.1.2.4.6 F) Conferences

2.1.2.5 2009 Results and Updates

2.1.3 New Administrative Methodology

2.2 Greece

Summary

2.2.1 Best tools for a good planning of the territory

2.2.2 The Regional/Local Energy Plan

2.2.3 The Regional/ Local Development Strategy

2.2.4 Public/Private Interests

2.2.5 References

2.3 Thaya county (Austria)

Summary

2.3.1 Best tools for a good planning of the territory

2.3.1.1 The Masterplan SHP for the federal land Lower Austria 2009



Policies, Methodologies & Tools to Improve the Exploitation of SHP

- 2.3.1.2 The strategy for the “Energy And Climate Model Region Waldviertel”
- 2.3.1.3 Regional energy plans for the micro regions in Waldviertel
- 2.3.1.4 Local Energy Plans for municipalities
- 2.3.1.5 Water data register Lower Austria – important source of information
- 2.3.2 Implementation of private & public joint investment -to promote the interest to invest in small scale hydro electrical production
 - 2.3.2.1 WEB AG - The regional participation model for renewable energy
 - 2.3.2.2 The actual planning for a regional energy contracting model
 - 2.3.2.3 Regional Energy Round Table in Waldviertel

3 Guidelines and Tools for a Technical and Economic Evaluation of SHP construction

3.1 NTNU, Norway

Summary

- 3.1.1 Choice of turbine, pipes and valves
 - 3.1.1.1 Annual mean flow rate in a river/stream
 - 3.1.1.2 Average flow capacity
 - 3.1.1.3 Pressure head
 - 3.1.1.4 Power
 - 3.1.1.5 Duration curve and service life
 - 3.1.1.6 Energy production
 - 3.1.1.7 Estimation of income on the basis of energy production
 - 3.1.1.8 Description and area of use for the different turbine types
 - 3.1.1.9 Choice of turbine type
 - 3.1.1.10 Penstock
 - 3.1.1.11 Design pressure for pipe
 - 3.1.1.12 Choice of pipe type
 - 3.1.1.13 Choice of valves
 - 3.1.1.14 Intake to penstock
- 3.1.2 Registration and Identification of Licensees and Interested Parties
 - 3.1.2.1 Establishing an overview over the licensees in question
 - 3.1.2.2 Informing the population about the possibilities in exploitation of the resources
- 3.1.3 New Technology – Description and Possibilities
 - 3.1.3.1 The development of turbine technology
 - 3.1.3.2 The development of pipes
 - 3.1.3.3 The development of generator technology
 - 3.1.3.4 The development of monitoring technology
 - 3.1.3.5 Remote control of the power plant
- 3.1.4 Analysis of resources in the lateral watercourses
 - 3.1.4.1 Map based survey of lateral watercourses that are theoretically viable – stage 1



Policies, Methodologies & Tools to Improve the Exploitation of SHP

- 3.2.5.2. Methods of economic evaluation
- 3.2.5.3. Tariffs and incentives
- 3.2.5.4. Revenue assessment - analysis of the financial behaviour of a small hydro power plant
- 3.2.5.5. Financing strategy
- 3.2.5.6. Cash flow analysis and implementation schedule
- 3.2.5.7. Unit cost of energy
- 3.2.5.8. Sensitivity and risk analysis
- 3.2.5.9. Economic life
- 3.2.5.10. Criteria for decision
- 3.2.6 Implementation and development of a small hydro power plant
 - 3.2.6.1. Contract packaging models
 - 3.2.6.2. Contract delivery models
 - 3.2.6.3. Financing schemes
- 3.2.7 DESCRIPTION of RETScreen® users' software
 - 3.2.7.1 Hydrology
 - 3.2.7.1.1 *Flow-duration curve*
 - 3.2.7.1.2 *Available flow*
 - 3.2.7.1.3 *Firm flow*
 - 3.2.7.2 Load
 - 3.2.7.2.1 *Energy demand*
 - 3.2.7.2.2 *Average load factor*
 - 3.2.7.3 Energy Production
 - 3.2.7.3.1 *Turbine efficiency curve*
 - 3.2.7.3.2 *Power available as a function of flow*
 - 3.2.7.3.3 *Plant capacity*
 - 3.2.7.3.4 *Power-duration curve*
 - 3.2.7.3.5 *Renewable energy available*
 - 3.2.7.3.6 *Renewable energy delivered - central-grid*
 - 3.2.7.3.7 *Renewable energy delivered - isolated-grid and off-grid*
 - 3.2.7.3.8 *Small hydro plant capacity factor*
 - 3.2.7.3.9 *Excess renewable energy available*
 - 3.2.7.4 Project Costing
 - 3.2.7.5 Validation
 - 3.2.7.5.1 *Turbine efficiency*
 - 3.2.7.5.2 *Plant capacity and annual renewable energy delivered*
 - 3.2.7.5.3 *Project costs*
- 3.2.8. References
- APPENDIX A: Example: The investment is not externally financed
- APPENDIX B: Example: The investment is externally financed
- APPENDIX C: FINANCIAL ANALYSIS
- APPENDIX D: TURBINE EFFICIENCY FORMULAE
- APPENDIX E: FORMULAE FOR FORMULA COSTING METHOD

3.3 ERSE, Italy



Policies, Methodologies & Tools to Improve the Exploitation of SHP

Summary

3.3.1 SHP informatic tools

3.3.1.1 Vapidro-Aste

3.3.1.1.1 Available, natural and hydropower flow

3.3.1.1.2 Potential hydro power calculation

3.3.1.1.3 Economic feasibility

3.3.1.1.4 The GIS software tool to evaluate the residual potential hydropower in a watercourse

3.3.1.2 Smart Mini-Idro

3.3.1.2.1 Discharge Module

3.3.1.2.2 Turbine selection Module

3.3.1.2.3 Energy calculation Module

3.3.1.2.4 Cost evaluation Module

3.3.1.2.5 Financial Analysis Module

3.3.1.3 Hydropower Investor Database Structure

3.3.1.3.1 Public Cadastre in the internet



Policies, Methodologies & Tools to Improve the Exploitation of SHP

1 Introduction: The rationale of the deliverable D3.1

The specific aim of the deliverable D3.1 is to make available policies, methodologies and “friendly-use” tools for a better assessment of water resources availability, for assessing potential mini-hydro plants sites in the territory (including related environmental constrains), for a complete economical & financial analysis of SHP plants (including eventual subsidies), to better communicate/disseminate opportunities to investors and to increase the interest of stakeholders to invest in small scale electric plants.

This digital handbook is a collection of independently written contributions from all the partner institutions of the SMART project as part of the work package 3 (WP3). The contributions are put on CDs and distributed to the partners. The tools presented are tested in the SMART pilot regions and the definite results of the use of the methodologies and tools presented in this handbook will be reported in the work package 4 (WP4). All the resulting reports of the SMART project can be downloaded from the following home page: <http://www.smarthydro.eu/?p=Deliverables>

It needs to be pointed out that due to differences in topography, climate, economics and politics between the different regions it is not possible to make one common strategy for all the regions. The aim is rather to exchange experiences and strategies (described in chapter 2 of this report), and develop tools (described in chapter 3 of this report), ***that can easily be adjusted*** by the user to fit the different regions.

The handbook provides an exchange of policies, methodologies and tools, and it will be up to the readers to choose what is the most interesting for them.

SMART
Strategies to Promote Small Scale
Hydro Electricity Production In Europe

WP 3 – Deliverable D3.1
Policies, methodologies & tools that may support decision makers in
implementing Small Scale Hydro Electricity Plants

**Description of the policies, methodologies, best
practices & tools that may support decision makers
in implementing
Small Scale Hydro Electricity Plants**

Chapter 2.1 Province of Cremona, Italy





Policies, Methodologies & Tools to Improve the Exploitation of SHP

2.1 Province of Cremona, Italy

Table of contents

Summary -----	3
2.1.1 The Development Pact -----	4
2.1.1.2 Definition-----	4
2.1.1.2 The course of the project-----	6
2.1.1.3 Means of implementation-----	16
2.1.1.4 The Pact and the young-----	31
2.1.2 The Environmental Energy Plan -----	33
2.1.2.1 Introduction-----	33
2.1.2.2 PEAP structure-----	33
2.1.2.2.1 <i>Part One: General Fact-Finding Framework</i> -----	34
2.1.2.2.2 <i>Part Two – Analysis of the energy system:</i> -----	34
2.1.2.2.3 <i>Part Three – Assessment of feasibility and effectiveness of actions</i> -----	35
2.1.2.2.4 <i>Part Four –Target scenarios</i> -----	36
2.1.2.2.5 <i>Part Five – Management tools</i> -----	36
2.1.2.3 Meetings and works that led to the drawing up of the energy plan-----	36
2.1.2.4 Actions undertaken-----	38
2.1.2.4.1 <i>A) Mini Hydro Power</i> -----	38
2.1.2.4.2 <i>B) Energy Exploitation of Biomasses And Biogas</i> -----	41
2.1.2.4.3 <i>C) Energy Saving in Public and Private Buildings</i> -----	45
2.1.2.4.4 <i>D) Promotion of Photovoltaic Power</i> -----	46
2.1.2.4.5 <i>E) Setting up a Provincial Office for the Public</i> -----	47
2.1.2.4.6 <i>F) Conferences</i> -----	47
2.1.2.5 2009 Results and Updates-----	48
2.1.3 New Administrative Methodology -----	53

Summary

Chapter 2.1 is the contribution of Province of Cremona to deliverable D3.1 of the of the European Project named SMART.

The present report is principally oriented to the Public Municipalities and to the investors. Province of Cremona believes that the bottom approach is the best way to satisfy the needs of the citizens and the community and it allows to realize much more things that normally procedure if there is the direct support from the stackholder.

In chapter 2.1.1, Province of Cremona describes the “The Pact for Development” that is an agreement which involves the whole provincial territory through a series of individual projects with the objective of improving the whole territory from an economic, social, environmental point of view, with the assumption of local involvement and collaboration.

In chapter 2.1.2, Province of Cremona describe its experience in the development of the “Environmental Energy Plan”, with the aim to organizing the energy sector from the point of view of the environmental aspects, indices of life quality and sustainability. Thanks to its potentials, it is adopted by many provinces, even though they are not obliged to, and thanks to the fact that its implementation is voluntary, the pilot projects that have been carried out still benefit from such flexibility that properly suits the features of the various local situations.

In chapter 2.1.3, Province of Cremona shows its “new administrative procedure” useful to give the concession to derive water and to authorize the Small Hydro Power Plant.

2.1.1 The Development Pact

2.1.1.2 Definition

The **Pact for Development in the province of Cremona** is an **agreement** which involves the whole provincial territory; it is made of a series of individual **projects** with the objective of improving the whole territory from an economic, social, environmental point of view, with the assumption of local involvement and collaboration.

It is an interactive way of working, through which the representatives of the territorial policy define together the aims of development, they elaborate concrete proposals and they commit themselves to the realization of projects which are supposed to be strategic for the attainment of the established objectives. It is open in time: it consists of a cultural modification in the realization of the development of a territory.

Context

The idea of the Pact for Development was conceived within a framework characterized by other experiences of strategic planning (Accordo Quadro di Sviluppo Territoriale/Framework Agreement for Territorial Development, Strategic Plan of the Municipality of Cremona – which will be explained later on) and it is based on an in-depth study on the province (indications of Objective Development– subsequently explained too).

A few months before the beginning of the works which would have brought to the Pact for Development subscription, the Giunta Regionale (District council) deliberated over the promotion of the **Accordo Quadro di Sviluppo Territoriale (AQST)** in the province of Cremona (for further information see pages 17, 18).

The AQST is a **device for negotiated planning** provided for in the regional law No 2, 14th March, 2003: it represents the modality by which **the Region places itself towards the local subjects for the sharing and the fulfilment of the regional policies on the territory and it makes easier to access regional funds**, useful for the concrete realization of the projects. Since the AQST and the Pact for Development have been considered suitable instruments to be combined, the participating institutions decided to integrate the two projects, exploiting the advantages of the homogeneity of the process and of the concentration of resources: the AQST established that it will acquire the contents of the Pact (results of the recognition made on the process of the Pact, analysis of the local context, detection of strategic areas for the territory development).

The agreement among Region Lombardia, Province of Cremona, C.C.I.A.A. (Chamber of Commerce) of Cremona, Municipality of Cremona, Municipality of Crema and Municipality of Casalmaggiore, involved in Territorial Groups of comparison promoted and coordinated by the Region since the end of 2005, was approved by the District Council through the Resolution of 30th July 2008. Some of the projects included in the Pact for Development have been inserted in the AQST, since they meet the point of the regional planning.

The **approval** of the Agreement took place on **14th November 2008**.

At present, a first monitoring of the AQST was realized and it led to an update of the projects contained. The process of definition of the **Strategic Plan for the Municipality of Cremona** was started by the **Local Council supported by Censis** (Social Investments Studies Centre, is an Italian social-economic research institute) which carried out a survey in the territory of Cremona in 2005 finding out positive and negative elements. Amongst the former, they identified the high incomes per head, the very low unemployment rates and an elevated productive capacity; on the contrary, the latter are represented by the relatively weak production structure, the geographic isolation due to the distance from the big communication links and to a traditional business culture which is not so predisposed to change.

An analysis document elaborated by Censis (updated as of June 2007) is available and it presents the strategic points of plans and projects and refers to the presentation of the project which took place on 9th March 2007. The strategic Plan of Cremona was approved by the Local Council on 1st December 2008. Afterwards, the other Municipalities deliberated, with suitable acts, their acceptance of the document and they totally approved the contents. On **20th April 2009**, in the Consultative room of the municipal Palazzo Comunale, **the majors officially signed the Strategic Plan “Cremona 2020”**. The alliance among the municipalities became official by means of a special Memorandum of Understanding, with which each body committed itself to collaborating in the elaboration of the Strategic Plan (promoted by the City of Cremona, as leader body), and each of them recognized its usefulness as an effective means of development. The aim is that of finding and *putting at system*, according to logics of integration, the peculiarities and the opportunities of the territories and of realizing strategic actions.

The relationship between the Strategic Plan and the Pact for Development became concrete through the active participation of the City of Cremona in the process of elaboration of the Pact and through the presence of Censis consultants when the stakeholders were involved.

There is also the **experience of “Obiettivo Sviluppo” (Objective Development) of the Chamber of Commerce**, which determines the projects, the actions and the works that the economic operators consider decisive for the development and the competitiveness of the territory starting from a reference frame which analyses the territorial, demographic, economic features of the area. It is a **way of reading the territory from the part of the economic categories**.

It was presented on **29th November 2004**.

Organizational structure

The Pact for Development project was proposed and started by some **promoting bodies**, namely the **Province of Cremona** (coordinator of the Pact), **CCIAA (Chamber of Commerce) of Cremona, Municipality of Cremona, Municipality of Crema, Municipality of Casalmaggiore**. These subjects work together through the supervision of the **Control Room**, a body endowed with a political direction and coordination functions over the whole process; this is supported by Region Lombardia which guarantees the coordination with the regional planning.

The organizational structure, then, is composed of a series of other Organizations.

The **Strategic Committee** is a body with representative and consultative functions and it **consists of 41 public and private local subjects** which represent the economic, social forces of the local bodies, of the universities and of the research centres belonging to the territory (Box 1 – the members of the Strategic Committee).

The **Technical Secretariat** provides an **organizational support** and it is composed of the technicians of the bodies which form the Control Room.

The **Thematic Groups** have been created with the aim of finding the projects that are consistent with the ideas of development, shared by the representative of the territorial policy, and able to produce a considerable impact on local development.

The **Scientific-methodological consultancy** is assigned to the **Laboratorio di Economia Locale - LEL - (Local Economy Laboratory) of the Università Cattolica del Sacro Cuore**, branch of Piacenza-Cremona, which follows the planning process.

Since the beginning of 2008, the **Office of the Pact** has been active and it has had functions of **organizational secretariat, filing of the documents** produced by the Pact and by its members, **window open to public and information point**; moreover it offers **traineeship and research programmes and the possibility to conceive new ideas**.

Moreover, between May and July 2008, the **Evaluation and Monitoring Unit** was officially created: it is a **technical working group** which verifies the State of Art of the Pact projects, the level of accomplishment and the effects on the local system.

Box 1 – Members of the Strategic Committee

Institutions:

- Province of Cremona – Promoter of the Pact and member of the Control Room
- Chamber of Commerce of Cremona - Member of the Control Room
- Municipality of Cremona - Member of the Control Room
- Municipality of Crema - Member of the Control Room
- Municipality of Casalmaggiore - Member of the Control Room
- Region Lombardia – Territorial offices of Cremona - Member of the Control Room as promoter of Accordo Quadro di Sviluppo Territoriale
- Delegation of municipalities with a limited demographic size (ANCI)
- Delegation of municipalities with a limited demographic size (Lega per le Autonomie Locali)

Trade unions:

- C.G.I.L., C.I.S.L., U.I.L.
- Agenda 21
- Reindustria - Agenzia Cre.Svi. S.Cons.r.l. (Local agency for industrial development)
- Associazione Industriali Cremona (Cremona Association of Industrialists)
- A.P.I. (Association of Small Enterprises)

Local and national craft associations:

- Confartigianato Imprese Associazione artigiani di Cremona (Ass.ne Artigiani)
- C.N.A.
- Libera Associazione Artigiani
- Associazione Autonoma Artigiani Cremaschi

Local and national associations of retailers:

- Associazione dei Commercianti della provincia di Cremona
- Associazione Commercianti di Crema
- Confesercenti
- A.SVI.COM.

Local and national associations of farmers

- Federazione Provinciale Col diretti, Libera Associazione Agricoltori Cremonesi, Confederazione Italiana Agricoltori

Local associations of cooperative societies:

- Confcooperative, Lega Cooperative

Schools and Universities:

- Politecnico di Milano (Branch of Cremona)
- Università degli Studi di Milano (Branch of Crema)
- Università degli Studi di Pavia (Branch of Cremona)
- Università Cattolica del Sacro Cuore (Branch of Piacenza and Cremona)
- Associazione Scuole Cremonesi Autonome
- Forum provinciale del Volontariato (Provincial volunteer forum)
- Delegation of the Associations of consumers
- Delegation of Cultural Associations
- Compagnia delle Opere Lombardia Sud Est (Company of south-west Lombardy works)
- Fondazione Banca Popolare di Cremona (Bank of Cremona)
- Fondazione Comunitaria della Provincia di Cremona (Community Fundation of the Province of Cremona)
- Federazione Lombarda delle Banche di Credito Cooperativo (Bank federation)
- ANCE Cremona – Associazione Costruttori (Association of buiders)

2.1.1.2 The course of the project

On 29th December 2005, the District Council approved the Accordo Quadro di Sviluppo Territoriale – AQST (instrument of negotiated planning) for the territory in the Province of Cremona through decision No 8/1639.

The work meetings in preparation for the Pact for Development took place *between January and March 2006*.

On 20th March 2006, the Coordination Committee of the AQST, which shares the course elaborated by the Pact for provincial Development, took office.

At the same time, the Control Room of the Pact was established: the course and the definition of the organizational structure of the Pact officially started In March 2006.

With the aim of understanding the sensitiveness and undertake a new and highly participative decisional course, meetings with some stakeholders of the territory took place *between February and May 2006*.

In order to start this structured process, it was necessary to analyse the strategic positioning of the territorial system.

The **SWOT analysis (Strength, Weakness, Opportunity, Threat)** proved to be a useful technique for this aim. Until the Eighties, it was only employed to define the competitive positioning of the companies with regard to their internal and external environment; afterwards, it was employed for the territorial and urban development evaluation. The four elements of SWOT analysis were redefined from a territorial point of view: in the internal environment, the strong points are the resources and the skills that the local systems employ to reach the established objectives, while the weak points are the problems and difficulties to face in the achievement of the aims; in the external environment, the opportunities are the positive situations which it is possible to take advantage of, and the threats are the risky situations that should be avoided.

LEL laboratory of Università Cattolica, by analyzing objective statistical data, identified the characteristic elements of the provincial territory. Afterward, the stakeholders involved were given a SWOT report, with the identified elements, together with a request of pointing out the territorial priorities. The information obtained from the study of the territory allowed to adapt this political typology (now widespread) to the local reality and it permitted to outline the basic trends.

On 8th May 2006, the Control Room established the Strategic Committee of the Pact.

On 9th June 2006, the first meeting of the Strategic Committee took place in Pizzighettone; during this summit, the participants expressed their consent to the kind of course to follow, they approved SWOT analysis, they assigned the tasks to the members of the Pact, they started the works for the definition of the medium-long term strategic lines.

On 18th July 2006, SWOT analysis (see table 1) was approved by the Strategic Committee, after the evaluation that had took place the previous month.

Between June and July 2006, the Strategic Committee identified the shared lines of action (namely, the strategic priorities of future development of the territory, intended as the ambits thanks to which it is possible to obtain a territorial development in terms of growth and competitiveness) for a sustainable and integrated development in the provincial reality from a systemic point of view and it provided the trend for the constitution of the **Thematic Groups**, that is the groups of work that delved into each subject.

The strategic axes identified are 8:

1. Agro-industrial system;
2. Innovation, research and training;
3. Renewable energy development;
4. Welfare and Social Integration;
5. Culture, tourism and creativity;
6. Reinforcement and improvement of the production system;
7. Material and immaterial infrastructures;
8. New relationships between P.A., citizens and companies.

On 9th November 2006, the Control Room of the Pact established the Thematic Groups and it identifies their composition and their way of working (Box 2 – The Thematic Groups: composition and functions).

**Table 1 – SWOT analysis
ECONOMY**

<p>Strong points</p> <ul style="list-style-type: none"> ➤ Agro-industrial sector: positive dynamics in the area of Crema with regard to number and experience of young entrepreneurs and concentration of more structured enterprises ➤ Good marketing level for the average production of milk (milk district and neighbouring provinces: Lodi) ➤ Typical productions of national-international relevance (Grana, Provolone, Torrone) ➤ Widespread entrepreneurship ➤ Marked potential for handicraft activities (production flexibility) ➤ Presence of some leading enterprises ➤ Reclamation of some abandoned areas (ex Olivetti) ➤ Good income per capita level and dynamics 	<p>Weak points</p> <ul style="list-style-type: none"> ✓ Primary sector: lack of generational change ✓ Agro-industrial sector: short against long production/distribution chain ✓ Scarce opening-up to international markets: modest levels of external trade and scarce inclination to export ✓ Lack of a production network with structured enterprises ✓ Weak initiative and opening-up to innovation (low percentage of high tech enterprises compared to the region and Italy, low number of patents) ✓ Inadequate infrastructural structure for the support and the growth of provincial development ✓ “Isolated” geographic position with regard to the main road networks
<p>Opportunities</p> <ul style="list-style-type: none"> ❖ Growth and rationalization of the migration flows ❖ Private financing availability for the integration of immigrants in the world of work ❖ Creation of corporate nurseries ❖ Introduction of cultural mediators in the companies ❖ “Equal” project ❖ Project of reclamation and rationalization of RSA (Healthcare residences) provincial network 	<p>Threats</p> <ul style="list-style-type: none"> • Ageing population • Worsening of immigrants’ quality of life • Difficulty in absorbing and improving human capital in the province • Limited number of graduates (both in supply and demand) in spite of the high university presence • Integration problems for foreign workers/citizens and worsening of social tensions

SOCIETY

<p>Strong points</p> <ul style="list-style-type: none"> ➤ Good quality of life level ➤ Presence of monuments and historic-artistic emergencies ➤ Spread presence of university structures in the territory and proximity to other important university centres (Piacenza, Brescia) ➤ Applied research centres ➤ Employment and company relevance of socio welfare structures (3500 RSA employees) ➤ Good presence of volunteer and social promotion organisations ➤ Good presence of cooperatives 	<p>Weak points</p> <ul style="list-style-type: none"> ✓ High rate of elderly people ✓ Penalizing demographic change of the population ✓ Defective natural balance ✓ Future demographic dynamics at a standstill without migration flows ✓ Low activity rate compared to the regional average ✓ Scarce female participation in the labour market ✓ Worsening of criminality indicators (Sole24ore); increase in the perception of insecurity
<p>Opportunities</p> <ul style="list-style-type: none"> ❖ Partial compensation of the migration flows; decrease in the local population of working age ❖ Extension of women's employment ❖ Recovery and improvement of the Territorial agency for development ❖ Presence of potential elements for tourism development ❖ Creation of the Beauty Treatment district ❖ Creation of the milk district ❖ Recovery of the industrial manufacturer system ❖ Recovery of the craft sector ❖ Piano Agricolo Triennale (Three-year Agricultural Plan) ❖ More careful access to EU funds (ESF and ERDF) ❖ Territorial tri-partition (Cremona, Crema, Casalmaggiore) which is to improve according to its specificities 	<p>Threats</p> <ul style="list-style-type: none"> • Increase in international competitiveness in the traditional mature sectors where Cremona shows certain specialization • Ageing population and scarce generational change in entrepreneurship and in the labour market • Scarce female participation in the labour market • Small-sized enterprises • Scarce internationalisation of enterprises • Exclusion from European funds (ESF and ERDF)

ENVIRONMENT

<p>Strong points</p> <ul style="list-style-type: none"> ➤ Attention to environmental problems ➤ Good presence of cycle tracks ➤ Presence of 14000/1000 ISO certified companies, according to the regional figure ➤ Increase in the Limited Traffic Areas and in the pedestrian precincts ➤ Attention to separate collection of waste ➤ Higher presence of usable green zones per citizen than the regional context ➤ Lower nitrate content in the water ➤ Public transport: low environmental impact means of transport and good level of employment of green fuel ➤ Low rate of illegal construction ➤ Good energy intensity index ➤ Increasing energy consumption per capita, but with restraint 	<p>Weak points</p> <ul style="list-style-type: none"> ✓ Presence of some environmental impact installations of production ✓ Limited spread of energy saving practices ✓ Moderate employment of public transport ✓ High levels of pollution from dangerous substances in water courses ✓ Phenomena of atmospheric pollution from fine particles and tropospheric ozone; the limits set out in sectoral legislation were often exceeded ✓ Increase in emitted CO2 per capita ✓ High electric deficit, though it is due to the agricultural attitude of the territory
<p>Opportunities</p> <ul style="list-style-type: none"> ❖ Attention to alternative, innovative and low environmental impact (biomass) energy policies ❖ Good presence of green areas ❖ Increase in the number of tourist farms ❖ Development of the fluvial tourism (Po – Lombardy river) ❖ Development of synergies between the agricultural and the industrial worlds for the spread production of green energy ❖ Supporting energy services improvement in buildings through mechanisms of certification 	<p>Threats</p> <ul style="list-style-type: none"> • Areas with a high traffic concentration and low traffic speed • Trade-off potential among residents' needs, installations of production and agricultural attitude of the territory

Box 2 - The Thematic Groups: composition and functions

The Groups are:

Group 1 – Agro-industrial system: coordinated by the Province of Cremona

Group 2 - Innovation, research and training and Reinforcement and improvement of the production system (the two axes were incorporated because of affinity and complementary of contents): coordinated by the Chamber of Commerce

Group 3 - Renewable energy development, energy saving and rational use of resources: coordinated by the Province of Cremona

Group 4 - Welfare and Social Integration: coordinated by Comune di Crema

Group 5 - Culture, tourism and creativity: coordinated by Comune di Cremona

Group 6 - Material and immaterial infrastructures: coordinated by the Province of Cremona

Group 7 - New relationships between P.A., citizens and companies: coordinated by the Province of Cremona

The Thematic Groups are constituted by the representatives of the local institutions, the social and economic categories, associative work, which displayed their interest and their willingness (through an appropriate written submission to the Technical Secretariat of the Pact) to take part in one or more groups of work.

The Province di Cremona, the Chamber of Commerce, the municipalities of Cremona, Crema, Casalmaggiore and Region Lombardia take part in all the Groups.

Each Group includes: one political coordinator, who represents the body that took charge of the coordination of the Group and one technical coordinator, namely a sort of “facilitator” of decisional processes and elaboration of final proposals, with the function of making easier the comparison of ideas, organizing the meetings, summarising the proposals and the final projects.

Moreover, the Groups are open to external experts and to the audition of realities which are considered important for the realization of the activities.

In the first months of work, each Group had to select and “take a census of” the existing projects regarding each line of action and formulate new projects. The final output was submitted to the Control Room and to the Strategic Committee.

At the beginning, the work of the Thematic Groups was the following:

- finding of the projects concerning the subject discussed (“census” of the existing projects);
- elaboration and proposal of new projects (planning ideas);
- selection of the projects that show suitable characteristics in order to be included in the Pact.

[The characteristics that the select projects presented, totally or partially, are detailed below:

- relevant impact on the competitiveness of the territory;
- completeness and project detail;
- equipment of necessary resources;
- possibility of being proposed for the financing of special funds.]
- for the select projects, elaboration of the project report;
- presentation of the work carried out to the Strategic Committee.

The Thematic Groups worked in parallel, with reciprocal influences in case of projects of shared interest.

Then the different Thematic Groups submitted their project proposals, together with the hypothetical scenario, to the Control Room.

The Control Room evaluated the proposals received from the Groups and it proposed the document made of the scenarios and the project proposals to the Strategic Committee. Indeed, the Strategic Committee is the organization that, in the system of the Pact, approves the strategic document.

In general, this was the method of selection of the projects then included in the agreement which was signed. The Thematic Groups have continued their meetings and discussions about the State of Art of the projects that are already being carried out, about the realization of projects in a start-up phase and about the proposal of new ideas.

From *December 2006 to May 2007*, the projects, the priorities and their respective responsibilities were defined through the meetings of the 7 Working Groups (Box 3 – Results of the meetings).

Each Group singled out specific lines of action.

1. Agro-industrial system:

- A. The milk system;
- B. Safe and biological food.

2. Innovation, research and training - Reinforcement and improvement of the production system:

- A. Cremona creates innovation;
- B. Training: business and work.

3. Renewable energy development:

- A. Cremona towards Kyoto;
- B. Energetic district.

4. Welfare and Social Integration:

- A. Human resources: between the present and the future;
- B. The territory for the house.

5. Culture, tourism and creativity:

- A. Governance of the tourist and cultural systems;
- B. Interventions on cultural assets, Parco dei Monasteri and musical system;
- C. Tourist accommodation capacity and reception.

6. Material and immaterial infrastructures:

- A. Navigability of the river Po;
- B. Intermodality and logistics between Pizzighettone, Cremona and Casalmaggiore;
- C. Broadband Internet.

7. New relationships between P.A., citizens and companies:

- A. Efficiency Observatory and collective networks of services;
- B. Active participation and e-democracy.

Box 3 - Results of the meetings

Group 1 – the agro-industrial system:

Meetings of 18.12.06, 30.01.06, 15.03.07: the programme of the Pact was presented to the representatives of the Strategic Committee; afterwards, the members dealt with the discussion of the project documents and the listing of the projects which were being carried out and defined the timing of collecting the projects. The subjects mentioned are: product quality and safety, necessary transformation and innovation of the agricultural sector, overcoming of emergencies due to legislation, need for training, need for aggregation between bodies, associations, individuals and private associations.

Group 2 - Innovation, research and training - Reinforcement and improvement of the production system:

Meetings of 18.12.06, 30.01.07, 13.02.07, 21.02.07, 19.03.07, 09.05.07: at the opening of the works, the importance of collaboration and sharing of the project undertaken by the local subjects was underlined; the project document model was then presented: the project documents are useful in order to collect new ideas, but also actions that are being carried out and have to be consolidated, so as to have an archive of the projects in progress which could represent a basis for future projects. With reference to the projects presented, a group of work was constituted to deepen the contents. Moreover, during one of the meetings, it was presented and discussed the opportunity of structural funds for 2007-2013 planning period, which joins the internal resources that are available thanks to the subscribers of the Pact. The subjects discussed are: enterprise innovation and development, spread of innovation, export, trade, energy, training provision, provincial training system, human resources strengthening, stabilization of job insecurity, facilitation of job-matching measures.

Group 3 - Renewable energy development, energy saving and rational use of resources: *meetings of 29.11.06 and 28.03.07:* after a brief explanation of the objectives of the Pact for development, the energy situation of the territory was presented, together with its opportunities and critical points. In particular, the attention focused on

the necessity of taking advantage of all the renewable energy sources that are available in the province, within a project of efficiency centred on energy saving.

Four areas of action were detected with the aim of creating content-driven projects, but also of learning from other experiences carried out elsewhere:

- biogas and biomass (*meetings of 18.12.06 and 23.01.07*): employment of renewable energy sources of agricultural origin;
- solar thermal and solar photovoltaic systems (*meetings of 18.12.06 and 23.01.07*): energy production from solar, thermal and photovoltaic installations;
- mini-hydroelectric system (*meetings of 19.12.06 and 24.01.07*): employment of water sources and small-scale hydroelectric installations;
- energy efficiency of buildings (*meetings of 19.12.06 and 24.01.07*): diffusion of culture and energy efficiency practices of buildings.

For each area, a group of work consisting of the members of the Thematic Group met.

In the groups of work, the project proposals and the financing possibilities were discussed, with the contribution of the organizations involved in the deepening of the different subjects.

Group 4 – Welfare and social integration:

Meetings of 19.12.06, 16.01.07, 16.03.07, 20.04.07, 09.05.08, 20.11.08: after illustrating the objectives of the Pact, the members underlined that the aim of the Group was attaining the definitions of some lines of action, on which some project proposals could focus.

Among the main themes: elderly people, disabled people, immigrants, young people, home policies, access to services and some problems related.

The inspiring principle is that of creating some “networks”, thanks to which the competences and the resources are shared among the local subjects so as to easily and quickly realize concrete objectives.

After the approbation of the agreement, in July 2007, the Group met on 9th May 2008 and on 20th November 2008, and it continued the discussion about the realization of the projects and about the proposal of new ideas.

Group 5 - Culture, tourism and creativity:

Meetings of 22.01.07, 20.02.07, 16.03.07, 02.04.07, 23.05.07: the programme of the Pact for Development was presented together with the purpose of the Group of emphasizing the projects, analysing, elaborating and evaluating the strategic projects aimed at the improvement of the territory from the point of view of culture and tourism.

The creation of two subgroups was considered; one of them is related to Culture, the other to Tourism, in order to analyse the several aspects concerning the two topics more carefully; afterwards, the Group plenary session summarized and finalized the situation.

Group 6 - Material and immaterial infrastructures:

Meetings of 21.12.06, 11.01.07, 25.01.07, 05.02.07, 01.03.07, 22.03.07, 29.03.07, 24.07.07, 18.02.08: considering the objectives of the Pact for Development, the Group proposed to give an answer to the increasing demand for people and goods mobility, both about long-distance relations and local relations, through a model of “sustainable mobility” which contributes to the improvement of the environmental situation with reference to waterway, railway, road immaterial infrastructures (for logistics and goods).

The main subjects were: river navigability, intermodality, infrastructural actions in the provincial territory with fast connection telematic network, infrastructural strengthening of the provincial territory, development of intermodality and logistics in the area between Cremona and Pizzighettone, intermodality and logistics services, cycle tracks, systems of environmental development, information and development services.

Group 7 - New relationships between P.A., citizens and companies:

Meetings of 18.01.07, 23.04.07, 09.05.07: the focus was on the necessity of realizing more effective ways in the arrangement of services on behalf of the Public Administration.

The quality of Public Administration’s services is strictly related to the competitiveness of the territorial system. An agreement among the participants is essential: the Group offered its support to the other Groups to analyse the select projects, from the point of view of the relationships between institutional and private subjects.

It is necessary to keep listening to the categories in order to give an organic form to the projects and to the innovation programmes about the subject under discussion and to share experiences and examples of good practices.

On 28th February 2007, the Province Council decides to include in the budget a specific fund for the financial support for the priority projects of the Pact for Development.

A first inventory-group of the projects proposed during the Group meeting was prepared between March and April 2007.

Since May 2007, the Coordination of the Pact has realized an updating of the projects with the results of the work of the Thematic Groups.

On 30th May 2007, the Control Room met in the seat of the Province to evaluate the work carried out and to draft the document which will be submitted to the Strategic Committee of the Pact.

The document “An agreement for the future” of the Pact for Development was approved by the members of the Strategic Committee on 9th July 2007.

It included more than 150 projects put within the emblematic actions (namely the specific lines of intervention) identified during the meetings of the Thematic Groups.

In the agreement, the **development outlooks** for the province of Cremona were defined:

1. Network of Innovation, whose central point is the reinforcement of the competitiveness for the traditional sectors of Cremona’s economic system and the attention to the subject of energy;
2. Network of Culture, of tourism and training, to realize through the combined improvement of the historic-monumental heritage and of the territorial-environmental dimension;
3. Strategic Collective Networks, which can be set up through the qualification of the services offered to citizens, companies and potential users of the territory as far as the system of infrastructures, the system of local welfare and the modalities of interaction between public administration, citizens and companies are concerned.

Since July 2007 many projects have started.

On 31st July 2007, through Decision No 395, the Province Council approves the criteria for the identification of the projects that were to be financed with the fund included in the provincial budget for the year 2007.

The criteria were: high degree of feasibility, presence of defined partnerships (with economical commitment), possibility of accessing to external financing sources, project capacity of creating flows of capitals deriving from structural, community, national or regional funds, priority identification of the project in the programming instruments under way.

The Provincial Council assigns the sum of € 241,000.00 to finance some projects that had expense procedures which were not liable to deferment, on 7th August 2007, through Decision No 420 (urgent variations in the budget).

In consequence of the financial support assigned, the availability of the fund decreased from € 700,000.00 to € 459,000.00.

On 30th October 2007, through Decision No 556, the Provincial Council established the distribution of the fund (in the form of restricted fund), to be included in the 2007 budget, for the projects of the Pact for Development. A report with a pre-established expiry date was chosen by the technical structure with reference to the State of Art of the projects and the contextual fixation of a deadline (30th April 2008), after which the assigned and non-employed funds would return to the Provincial budget.

Moreover, the involved managers were asked to draw up a report about the State of Art of the financed projects by 30th March 2008 (the acts that document the employment of the funds would have to be pointed out in detail).

In the end, it is important to underline the necessity of making coherent the strategic planning of the body through the instruments of financial planning; for this purpose, some recommendations for the formation of the future budgets were provided, such as the allocation of resources for the strategic and innovative projects that reveal a low degree of feasibility at the moment or that have characteristics that make them eligible for not yet defined financing of the European Union, and the allocation of resources for the co-financing of the actions that can be proposed for the Structural Funds and for the EU Programmes.

Since *October 2007* the selection of the programmes has started according to characteristics of feasibility, partnerships definition and capacity of creating flows of capitals in order to obtain regional, national and EU financial supports.

The Technical Secretariat of the Coordination Committee met to select and define the projects that could be included in the AQST on *8th November 2007*.

The Strategic Committee of the Pact met in Crema on *26th May 2008*. One topic of the meeting was the State of Art of the projects and of the activities of the Pact. Moreover, the Committee officially recognized the Evaluation and Monitoring Unit and it introduced the Office of the Pact for The Development.

The Evaluation and Monitoring Unit officially took office on *4th July 2008*. The following meetings took place on *13th October* and on *10th November 2008*. [For further details, see the chapter about Strategic Monitoring and Evaluation, p. 35]

The Provincial Council assigned the allocation of the fund included in the budget for the projects of the Pact for Development, through Decision No 543, *30th September 2008*.

During the meeting of the Strategic Committee which took place in CremonaFiere on *20th November 2008*, the focus was on the instruments for the realization of the Pact for Development (financing sources), on the setting out of the activities of Strategic Evaluation and Projects Monitoring, on the approval of the AQST (which took place on *14th November 2008*, in Milan) and on the State of Art of the projects financed by the provincial fund of the Pact in 2007 and 2008.

On *3rd April 2009* the meeting of the Strategic Committee at CCIAA of Cremona dealt with the local strategies with respect to the present crisis. Some projects realized were discussed after they had been pointed out by the coordinators of the Thematic Groups. During the meeting, the participants approved the “Agreement Protocol for the sharing of the information and of the anti-crisis measures”.

The Provincial Council assigned the distribution of the fund present in the budget for the projects of the Pact for Development, through Decision No 194, *7th April 2009*.

Synthesis of the project

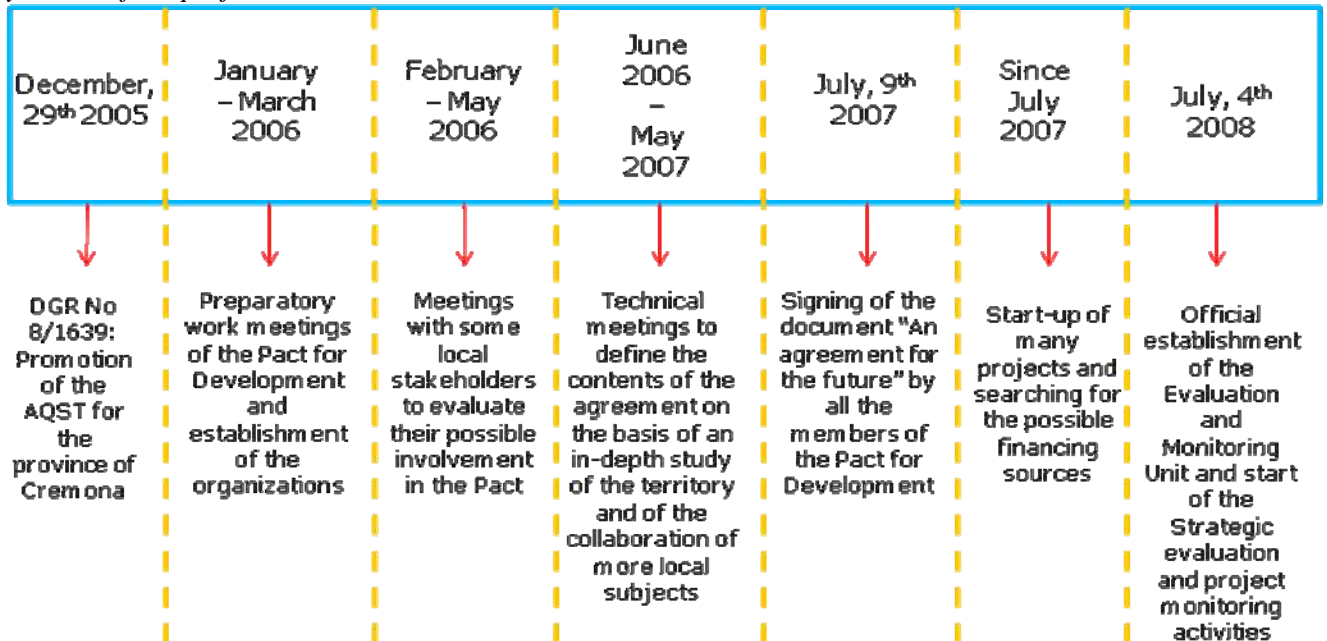

2.1.1.3 Means of implementation

The types of financial support for the projects consist of:

- Internal resources,

Available thanks to the members of the Pact for Development.

- External resources:

- 1) Regional resources
- 2) Ministerial resources
- 3) EU resources
- 4) Resources from other origin

The **external resources** finance – primarily – the projects present in specific territorial agreements.

Therefore, the Pact for Development is essential in order to intercept these resources, but it has to integrate with the planning acts of the external bodies.

1) Regional resources

The *Accordo Quadro di Sviluppo Territoriale* (AQST) is a device for negotiated planning provided for in the regional law No 2, 14th March, 2003.

The negotiated planning is the way by which the Region deals with the local bodies for the sharing and the realization of the regional policies on the territory.

The AQST for the province of Cremona started with decision of **promotion** of the agreement on behalf of the Regional Council No 8/1639 on **29th December 2005**.

The agreement among Region Lombardia, Province of Cremona, Municipality of Cremona, C.C.I.A.A. of Cremona, Municipality of Crema and Municipality of Casalmaggiore which were involved in Territorial Groups of comparison, promoted and coordinated by the Region, was finally **approved** by the Regional Council with Decision VIII/007783 on **30th July 2008**.

The **signing of the agreement** by the local actors and by the President of Region Lombardia, Roberto Formigoni, took place on **14th November 2008**.

The AQST is a priority instrument of planning, financing and realization of the actions that are included, for which some kinds of facilitations of access to regional funds are considered, and it represents one of the methods for the concrete realization of the development objectives defined and shared with the course of the Pact for Development in the province of Cremona.

In the AQST, the projects for the Pact for Development which were compatible with the regional planning were incorporated at first; afterwards, other projects proposed by the participants have been added.

Some Directorate General of the Region which assign aids on the basis of specific regional laws or, in any case, of financial supports directly coming from the regional budget (e.g. the DG Turismo), apply the principle according to which the resources are assigned, firstly, to the projects included in the AQST. This practice cannot be considered a general principle.

The AQST agreed upon contains the realization of a “First Programme of Action” for already shared activities which are placed in a high level of planning and financial definition; a commitment is established to deepen an “Integrative Programme of Action” for actions which are considered essential, but which are characterized by a not sufficiently improved planning and with a financial situation that has to be verified.

The agreement can be revised and integrated half-yearly.

Further to the deliberation of the Regional Council that promotes the AQST, some groups of work have been established in the province in preparation of **EXPO 2015** in order to be the reference for the evaluation of the initiatives that the territories mean to propose; for Cremona’s area, it was agreed that the Territorial Group established for the AQST was also the suitable seat to debate EXPO projects: the group of work met to examine the project proposals elaborated in the territory which will be presented to EXPO Control Room.

With reference to the present crisis, Region Lombardia has elaborated a package deal which regards Cremona’s territory (Box 4 – Anti-crisis measures).

Also at a local level, there is the consciousness of providing **unitary, concrete and immediately perceivable answers** and of **creating the basis for a permanent development in the future**, so as to face the importance of the crisis.

The Province and the Chamber of Commerce have proposed a series of operational and method protocols to face the crisis. At the Province, it will be created a Group where the members can interact to exchange analyses, information, proposals and projects for the control of the crisis, of the social troubles which follow and for supporting and sustaining the coming out of the crisis.

The local involvement is facilitated by the effort of involvement and negotiation of the local actors which started with the Pact for Development.

Box 4 – Anti-crisis measures

The **Regional Council approved a package deal of thirteen anti-crisis measures** for an amount of 3 million euros, together with a financing of 1 million euros headed for enterprises to support innovation, internationalization, trade services and actions in favour of those firms that have claims against the Public Administration.

Among the most significant measures for the territory of Cremona there are:

- Support for credit, both through “Fondo artigiano” (48 million euros), in favour of craft firms, and through “Made in Lombardy” (35 million euros) that facilitates medium term unsecured financing for PMI (small and medium-sized enterprises) and large enterprises of the manufacturer sector;
- Support for entrepreneurship: both through the Call about trade districts (22.5 million euros – Call expired) for the promotion of urban trading areas, and through FRISM funding (revolving fund mechanism for entrepreneurship – available resources: 60 million euros) in favour of the co-financing of business development

investments, the consolidation of the assets and the transfer of enterprises. Moreover, the entrepreneurs will be able to obtain the fund allocated in order to support competitiveness development of tourist undertakings for structures and services qualification and product and process innovation. The District of Music project (Group “Tourism, Culture and Creativity”) will be probably proposed; this project intends to qualify, improve and integrate the offers related to music that are present in the provincial territory so as to characterize the whole province for promotional purposes;

- Support for innovation: through the co-financing of research and development investments, in favour of small and medium-sized enterprises and micro enterprises of the manufacturer and service sectors through FRMI fund of ERDF. Since April 2009, it had been possible to display demonstrations of interest about the “institutional agreements” fund for an amount of 20 million euros in favour of private enterprises to obtain a support for industrial research and precompetitive development projects in the priority thematic areas: agro-industrial, energy/environment, health, advanced craft sectors;

- Support for internationalization in favour of micro and macro projects of small and medium-sized enterprises for internationalization projects aimed at the consolidation of the presence of the firms in Lombardy belonging to different production sectors; it is co-financed by the Region with 4 million euros and by the System of Chambers with 3 million euros

- Guarantee: allocation of several funds to support financing supply for small and medium-sized enterprises (Fondo ConFiducia, 20 million euros), “confidi di primo grado” [small and medium-size enterprises consortium providing collective credit guarantees] (Trade – Agriculture – Tourism Guarantee, 7.5 million euros and JEREMIE ERDF fund, 20 million euros) and in support of organizations operating in social exclusion area through JEREMIE ERDF fund with 10 million euros.

2) Ministerial resources

❖ Fondo per le Aree Sottoutilizzate –FAS (Fund for the Underused Areas)

The fund was established with the law No 289 (Italian Budget Law for the year 2003), 27th December 2002, and modified with the law No 296 (Italian Budget Law for the year 2007), 27th December 2006.

It is the financing instrument, with additional national resources, of the development policies for the underused areas of the Country. In these areas, these resources add to the ordinary ones and to the co-financing EU and national ones.

The Italian Budget Law for the year 2007 included the **common planning of the additional, national and EU resources** within the Quadro Strategico Nazionale – QSN – (Italian national strategic reference framework) for 2007-2013 cohesion policy.

It was originally made of two communicating funds: one at the Ministry of Economy and Finance and another at the Ministry of Production Activities. At present, the fund is unified at the Ministry of Economic Development.

The employment of FAS resources can be realized by **financing interventions represented by public investments** (for material and immaterial infrastructures) and by **incentives to private organizations**.

Decision No 11 of CIPE (Comitato Interministeriale di Programmazione Economica – Joint Ministerial Committee for Economic Planning), dated of 6 March 2006, on the acknowledgment of FAS implementing projects of strategic interest in the regions: Emilia-Romagna, Liguria, Lombardia, Marche, Piemonte, Toscana, Umbria, Valle d’Aosta and in the autonomous province of Bolzano (point 3.1.3 of CIPE Decision No 166/2007 and subsequent amendments) updates the “Fondo per le Aree Sottoutilizzate” envelope and the resources assignment for the regional and interregional strategic projects and for the service objectives and it modifies Decision No 166/2007 on the realization of the National Strategic Framework and on the planning of the “Fondo per le Aree Sottoutilizzate” which includes technical-administrative and financial procedures for its realization.

For the Region Lombardia, the fund changes from 846.566 million euros to 793.353 million euros.

The priority axes are:

Axis 1: Reinforcing mobility networks and services for a sustainable development

Specific aims:

- Reduction of the infrastructural deficit
- Enhancement of public transport
- New tariff system for Public Transports
- Integrated Security

Axis 2: Increasing competitiveness through the development of knowledge and welfare

Specific aims:

- Measures supporting the young, the elderly and maternity
- House policies
- Reduction of the digital divide
- Innovative energy
- Improvement of the Territory, the architectural heritage and the cultural events

Among the projects that FAS funds will finance there are two **Special Strategic Projects (PSS)**: “River Po valley” and “National extraordinary programme for the production, economic recovery of polluted industrial sites” where the provincial territory proposed to access.

“River Po valley” project aims to be the engine for the start of an integrated policy of intervention in the sectors of the defence of soil, the protection of water and environmental resources, and the improvement of the territory, in the area of the river Po; this can be achieved by going beyond sectoral logics of intervention and by fostering the coordinated and synergetic employment of the several available financial instruments. The effective realization of the strategy implies a strong territorial integration and coherence with 2007-2013 QSN objectives and with European policies (e.g. “Birds” and “Habitat”, “Water protection and administration”, “Risk of inundations” decisions).

The *Special Strategic Project (PSS)* “National extraordinary programme for the production, economic reclamation of polluted industrial sites”, approved by CIPE with Decision No 166/2007, aims at the “promotion of advanced methods of integrated measures for the environmental reclamation and the industrial renewal in order to return the industrial areas damaged by pollution to a collective and productive use”, through the creation of new production activities or the environmental adjustment or improvement of the production activities already existing. The project is carried out, on the basis of Article 252 bis of D. Lgs. 152/06, in perimetric territorial areas inside the Polluted sites of National Interest and Sites of Regional Interest; among the latter, as far as Region Lombardia is concerned, Cremona-Tamoil Golena Aperta area is included again. The site pointed out as “Raffineria Tamoil (oil refinery)– Golena aperta” is the crucial point of a complex and wide operation of reclamation and reindustrialization of the western part of Cremona, which is associated with other reclamation and drainage actions already started or in course of definition. In particular, measures supporting the reindustrialization and the infrastructures, besides drainage interventions, are considered. These measures represent the essential elements of the project which was presented to Region Lombardia and to the Ministry of Economic Development within the Special Strategic Project.

3) EU resources

Since 1986, with the Single European Act which assigned new powers to the Economic European Community (now EU), the European Union has pursued a policy of cohesion and it has supported policies at a regional level in order to reduce the development gap among the European areas (art. 158 EC Treaty).

2007-2013 period of planning includes three objectives:

1. Confluence, aimed to hasten the development of backward areas;
2. Territorial competitiveness and employment, which sights to strengthen competitiveness and attractiveness among the regions besides creating new and better jobs;
3. European territorial cooperation, intended to improve cohesion among neighbouring and non-neighbouring regions and among countries.

The financial instruments to reach these objectives are provided by direct financial supports from the European Commission and by **decentralized off management financial supports, among which there are the structural funds (which the Italian Regions are in charge of).**

▪ **The European Regional Development Fund (ERDF)**

The structural fund that nowadays plays an important role for the province of Cremona is the European Regional Development Fund (ERDF): in 2007, the province of Cremona enters ERDF allocation for the first time. Until 2006, the fund was intended to support only some areas of the regional territory and our territory was not included.

The projects collected in the Pact and included in the AQST represented an important basis in order to apply for ERDF financial support: without this effort of preparation and negotiation the territory would have been more unprepared, as far as both the contents and the structures are concerned. In the province of Cremona, the administrative structures that had followed the Pact for Development became the “channel” that prepared the projects according to the rules established by Region Lombardia to obtain these funds.

Moreover, most of the projects that will be presented are projects shared by the territory, so that it is easier to avoid the fragmentation of the initiatives and therefore the possibility that different organizations of the same territory present projects that compete with each others.

Indeed, after an initial opening to the mechanisms of negotiated planning, the Region adopted for all the axes of the European Regional Development Fund the choice of a selection by Call for tenders to allocate the funds. In this situation, the wider the concentration of choices and resources is (50% of the projects has always to be financed), the more the chances of obtaining the funds are. For 2007-2013 period, within 2007-2013 Regional Operational Programme (POR) of Region Lombardia, we can Call that the availability of the fund amounts to 532 million euros, distributed in 4 axes of intervention:

ERDF axis of intervention	Availability in Region Lombardia
1. Innovation and economy of Knowledge	About 263 million euros
2. Energy	About 50 million euros
3. Mobility and sustainability	About 139 million euros
4. Protection and improvement of the natural and cultural heritage	About 60 million euros

On **Axis III**, in February 2009, further to the emanation of a specific invitation, some demonstrations of interest were displayed with regard to some project proposals (also included in the AQST):

1. ***“Laying of a second track in the section Cremona – Cavatigozzi (Cremona’s quarter)”***, project presented in partnership with RFI Spa firm (Rete Ferroviaria Italiana - Italian Railway Network) (proponent body) and Municipality of Cremona.

The project regards the doubling of the track between the stations of Cremona and Cavatigozzi. The doubling will take place beside the existing track and it needs the solution of the junction points into the respective railways lines, considering Cremona’s side, the insertion of the line of Castelvetro Piacentino village, and Cavatigozzi’s side, the goods lines (10 tracks) and the marshalling tracks (to be extended). The “supporting function” of the yard of Cavatigozzi will grant the suitable railway capacity to the port siding also in prospect of the development of storage structures included in rubber/iron/water interchange system. The presence of the single track on the whole provincial railway network implies an intrinsic rigidity of the traffic and a low level of regularity with negative consequences on the traveller service and, in the direction east-west Codogno-Cremona-Mantova, also on the goods service. Anyway, the potentiality development of the railway yard of Cavatigozzi (obtained also through the track set-up) has to be associated with the improvement of the traffic from Cremona’s railway junction, with the laying of the second track in the section with Cremona and with the goods yard and the electrification of the track that connecting Cavatigozzi to the port. The total amount conveyed in the Call for interest of February 2009 is € 29,200,000.00 and the sum asked as ERDF co-financing is € 14,600,000.00.

Further to the publication of the Call, it is necessary to revise the financial plan, since 3.1.2.1. line (“Infrastructural interventions for the development of goods intermodality”) establishes a maximum distributable contribution on ERDF funds of 10 million euros. In conjunction with the Territorial and Transport sector, the contacts with RFI Spa firm (Rete Ferroviaria Italiana - Italian Railway Network) (proponent body), which is waiting for defying the responsible of the projects, have been resumed.

2. ***“Improvement of the railway junctions for Cremona’s port area”***, project presented in partnership with two local firms, as Acciaieria Arvedi Spa and Oleificio Zucchi Spa.

The new railway junction would realize, in the industrial area of the port of Cremona, a new connection at disposal of “Oleificio Zucchi Spa” factory and a development for Acciaieria Arvedi factory which is realizing a doubling of its activity. These two firms extend along an existing junction which leaves beside the station of Cavatigozzi – on Cremona-Codogno railway line – to connect the port area and other firms in the area. Now it is intended to promote the extension of the junction to other firms in order to increase the goods railway traffic where the new goods yard/logistics hub of Cremona is located.

The total amount for the project, conveyed in the Call for interest (with reference to 3.1.2.1. line “Infrastructural interventions for the development of goods intermodality”) of February 2009 is € 1,977,225.00 and the sum asked as ERDF co-financing is € 988,612.00.

In conjunction with the Territorial and Transport sector, technical reference of the project, some meetings will take place in order to verify the projection stage and possible problems of realization. However, the project presented by Oleificio Zucchi factory will probably be withdrew because of the extremely advanced state of realization; some critical points were also underlined with regard to the definitive drawing up of the Call; with regard to “Acciaieria (steelworks) Arvedi”, some verifications, both of technical and financial nature, are being carried out with the project staff of the company. In order to unravel some doubts on the

interpretation of the text of the Call, some questions were formalized to the responsible of the line.

3. S.P. n. 26 “Brazzuoli – Pieve d’Olmì”. Southern ring road of Corte de’ Frati and Aspice village with realization of a tollgate on A21 motorway – presented in partnership with Municipality of Corte de’ Frati and Autostrade Centro Padane SpA.

The project aims at modifying the secondary road system constituted by SP No 26 “Brazzuoli – Pieve d’Olmì” through the realization of the alternative route to the areas of Corte de’ Frati and Aspice in order to rationalize the junction between the main road system, constituted by SS 45 bis “Gardesana Occidentale”, and the new tollgate of Corte de’ Frati, located at km 203 + 600 of A21 motorway, as well as of the neighbouring industrial area of Corte de’ Frati. The project proposal also includes the building of the mentioned tollgate.

The total amount for the project, conveyed in the Call for interest of February 2009 is € 16,400,000.00 and the sum asked as ERDF co-financing is € 7,800,000.00. Further to the publication of the Call, it is necessary to revise the financial plan, since 3.1.2.2 line (“Development of the secondary road networks through the improvement of the connection to the primary transport networks (Ten-t)”) establishes a maximum distributable contribution on ERDF funds of 7.5 million euros. The Calls regarding the four lines of action of Axis III were issued on 22nd May 2009. The applications have to be submitted by 150 days as from the issuing of the Calls (by October, 19th 2009), while the highest obtainable contribution is the 50% of the admissible costs. With regard to:

- the line 3.1.1.1 “Urban accessibility and integration of the stations for the development of the railway transport and passengers intermodality”, the total financing support is 45 million euros;
- the line 3.1.1.2 “Integrated interventions for the reduction of the environmental impacts deriving from urban and interurban mobility”, the total financing support is 7 million euros;
- the line 3.1.2.1 “Infrastructural interventions for the development of goods intermodality”, the total financing support is 40 million euros;
- the line 3.1.2.2 “Development of the secondary road networks, through the improvement of the connection to the primary transport networks (TEN-T)”. The total financial allocation is 35 million euros.

For the submission on **ERDF Axis IV**, whose Calls closed the 28th May 2009, two PIA, Progetti Integrati d’Area (Integrated projects of area) have been deigned:

- the project “*Greenways sul fiume Oglio*” (Greenways on the River Oglio);
- the project “*Isole e Foreste tra Adda e Po*” (Islands and forests between the River Adda and the River Po).

The whole project, entitled *Vie d’Acqua* (Waterways), is oriented to the implementation of coordinated actions in which the environmental, cultural, infrastructural resources consist of a single, long path which runs along Cremona’s waterways.

▪ **The European Social Fund (ESF)**

The European Social Fund, another structural fund, finances training activities and in support of the development of the human capital and of the work placement for the young, the unemployed and disadvantage people.

The fund availability is about 798 million euros for the regional territory, in 2007-2013 planning period.

ERDF axis of intervention	Availability in Region Lombardia
1. Adaptability	About 199 million euros

2. Employment	About 199 million euros
3. Social inclusion	About 79 million euros
4. Human capital	About 255 million euros
5. Transnationality and interregionaliy	About 31 million euros

Regarding the **direct financial supports by the European Commission** (through several EU bodies), the ***S.M.A.R.T. project*** (“Strategies to proMote small scAle hydro electRicity production in Europe”) is co-financed by the European Commission through ***Intelligent Energy – Europe – Programme, Call 2006***, which is included in the field of the actions aimed to reduce the non-technological barriers which restrict the diffusion of the distributed generation.

Intelligent Energy – Europe Programme 2003-2006 (Decision No 1230/2003 of the European Parliament – Article 5) was studied to support EU policies in the field of energy, as it is established in the Green Book regarding the Security of the Energetic Supplying, in the White Book about Transports and by EU legislation.

The programme is organized in four specific fields and SMART project is placed in the programme: ALTENER – Vertical Key Action 7 – Small-scale RES applications – Call 2006, which deals with the promotion of new, renewable sources of energy, for the decentralization of electricity production and their impact on local environment.

GPPinfoNET project (Green Public Procurement Information Network) obtained a co-financing on ***LIFE+ 2007 programme***. LIFE is the financial instrument established by the European Union to contribute to the realization and the development of EU policy in the sector of environment and environmental legislation.

4) Resources from other origin

Among the resources from other origin, **for the year 2009, Fondazione Cariplo** (a private foundation with banking origin) **intended to assign some contributions to the province of Cremona to support the initiatives that will be carried out in the territory, in the field of “Emblematic Actions”** that yearly finance, in rotation, the provinces of traditional reference. Fondazione Cariplo specifies that the projects have to be of significant dimensions, in order to produce a positive, elevated impact on the quality of life and on the promotion of cultural, economic, social development in that territory.

The project **Fabbrica della Bioenergia** (Bioenergy Factory), promoted within the Energy Group, will be presented to the Call for 2009 emblematic funds too, as well as the **recovery of Parco dei Monasteri** – an historical area in Cremona city (realization of an auditorium in the ex Cavallerizza building – which host soldiers in the XIXth century – with rehearsal room annexed and two rooms for chamber music with rehearsal room in the former monasteries of Corpus Domini and San Benedetto – and reclamation of ex Goito barracks). Moreover, Fondazione Cariplo is financing the drawing up of the feasibility study for **the realization of Cre.Ar.T.E Cultural District**.

Synthesis of the external resources

Regional resources	Ministerial resources	EU resources	Resources from other origin
<ul style="list-style-type: none"> • Accordo Quadro di Sviluppo Territoriale • Specific funds • EXPO 2015 • Anti-crisis measures 	<ul style="list-style-type: none"> • Fondo per le Aree Sottoutilizzate –FAS (Fund for the Underused Areas) • Specific funds 	<ul style="list-style-type: none"> • European Regional Development Fund (ERDF) • European Social Fund (ESF) • Direct management financing from the European Union 	Fondazione Cariplo

Projects implemented (State of Art of 3rd April, 2009)

Among the several projects included in the agreement signed in July 2007, here below there are some information about the projects which have been carried out (as notified by the coordinators of the Thematic Groups):

Strategic axis 1 – The agro-industrial sector of Cremona

Biosecurity in cattle and pig farming

Industrial tomato district among the provinces of Parma, Piacenza and Cremona

De.Co. for the agro-industrial products of Cremona's tradition

- Biosecurity in cattle and pig farming:

It consists of actions of breeders awakening and information about the correct application of all the procedures of farm management in order to avoid any risks for animal and human health.

By drawing inspiration from this project, the regional Health System has predisposed a plan of action that includes the intervention of ASL (local health unit) veterinaries in the farms; this job is nearly superimposable on that of APA (Associazione Provinciale Allevatori – Breeders Provincial Association) technicians, but with a prescriptive character.

- Industrial tomato district between the provinces of Parma, Piacenza, Cremona and Mantova:

The project aims at improving the competitive position of the whole territorial production system: from agriculture to the industry of transformation, through the development of policies for the quality, the improvement of the bargaining forms, a cut in the costs of tomato production and transformation, the participation in the sector policies.

The “Associazione Distretto del Pomodoro da Industria” (association of the Industrial Tomato District) among the provinces of Parma, Piacenza, Cremona, Mantova was officially founded on 27th July 2007 in Parma.

- *De.Co. for the agro-industrial products of Cremona’s tradition:*

It is a certificate established by the Municipalities for the recognition, the promotion and the protection of the products of the territory.

In 2006, the Municipal Council approved the regulations that establish the general principles for the attribution of this recognition.

The first four De.Co. products are: the sausage of Cremona, the “Torta Bertolina” from Cremona, the “Torta Turunina”, the “Marubini”.

***Strategic axis 2 – Innovation, research, training, strengthening
and improvement of the production system***

Innovation for the competitiveness of micro, small and medium-sized enterprises of Lombardy region

Cremona System abroad

Memorandum of Understanding between Reindustria Agenzia Cre.Svi and the Official Credit Institutes

Emblematic action: “FORMAZIONE: IMPRESA E LAVORO” (Training: business and work)

Beauty Treatment Technological centre

Soundlab – Advanced acoustic laboratory

Meccanica Eccellenza Cremonese (MEC)

- *Innovation for the competitiveness of micro, small and medium-sized enterprises of Lombardy region (Innovation Call):*

The projects presented on the Call have a high technological content. In the 2007 the Call had a great success and the enterprises of the Province that took part in the projects were very satisfied. Even 2008 Call was considered of great interest by the local production system, in spite of the difficult economic situation.

Cremona’s firms involved were totally 43: 27 for 2007 Call and 16 for 2008 Call.

- *Cremona System abroad*

The actions aimed to improve the opening of Cremona’s economy to the international markets, thus improving innovation and commercial capacity, broke down into the specific actions provided for by Axis 2 of the Accordo di Programma (agreement) on competitiveness; they fund a financial support from Region Lombardia on the voucher, the project on foreign buyers for *Bontà* trade fairs and *Fiera Internazionale del bovino da latte* (Dairy cattle international trade fair) and F.A.R.E. project.

- Memorandum of Understanding between Reindustria Agenzia Cre.Svi and the Official Credit Institutes:

The agreements recently renewed (March 2009) confirmed the willingness of the Credit Institutes to support the production excellence in our territory, with a ceiling of 55 million euros.

- Emblematic action: “FORMAZIONE: IMPRESA E LAVORO” (Training: business and work):

By now, the knowledge system has become an absolutely essential factor in order to support and develop territorial competitiveness.

For the projects regarding the Training Centres (Art of violin making, Musical Culture, Artistic Craftsmanship, Beauty Treatment, Agro-industrial sector), it is essential to carry on the work started experimentally.

- The Technological Cosmetic Pole (cluster*):

The synergies deriving from the interrelations among different business fields strengthen the positions of the involved firms, by taking advantage of the connections among the different activities. They develop innovation strategies in order to aim at the quality of the product and to make easier to enter the international markets. Particular attention to human resources was given by the project of the Training Centre.

- Soundlab – Advanced acoustic laboratory:

It consists in the creation of a laboratory which develops a technical-scientific continuous research on the acoustic scope needs.

The study on feasibility was carried out and financed by the Region Lombardia and CCIAA.

- Mechanics Excellence of Cremona (MEC):

In response to *Direzione Generale Industria* decree, PMI (small and medium-sized enterprises) and Cooperation, No 6914 dated of 26.06.2008, on the approbation of the Call for the presentation of proposals aimed at the realization of projects for competitiveness development, in accordance with the Regional Law 1/2007, one of the expressions of interest displayed by the territory of Cremona concerns the creation of MEC, the local Mechanics Pole (cluster*), in the territory.

* Cluster is "a geographically proximate group of interconnected companies and associated institutions in a particular field, linked by commonalities and complementarities" (Michael Porter's definition).

Strategic Axis 3 – Renewable energy development

The Green Public Procurement Information Network (GPPIInfoNet) – CompraVerde-BuyGreen

Fabbrica della Bioenergia (Bioenergy Factory)

S.M.A.R.T. “Strategies to proMote small scAle hydro electRicity producTion in Europe”

Energetic Certification of buildings

- *The Green Public Procurement Information Network (GPPInfoNet) – CompraVerde-BuyGreen:*

Through GPPInfoNet, the public bodies can significantly reduce the environmental impacts associated with the use of goods and services they buy and they can have a decisive influence on the market.

It is necessary to elaborate a series of instruments of guidance and operation support for GPP realization, through the organization of seminars and the creation of regional networks, the exchange of good practices and communication activities.

The project obtained a EU co-financing on LIFE + 2007 programme and it was included in Expo 2015 Technical Group.

The project is related with CompraVerde-BuyGreen, the International Forum for Green Purchasing, which took place at Cremona Trade Fair on October 9th and 10th, 2008 (2nd edition) and the 3rd edition is already being planned.

- *Fabbrica della Bioenergia (Bioenergy Factory):*

It regards the creation of a research, experimentation, technology transfer centre which has the objective of providing the territory with the most advanced techniques of management and functioning of the machineries for bioenergy production.

The project was included in Expo 2015 Technical Group.

- *S.M.A.R.T. “Strategies to proMote small scAle hydro electRicity producTion in Europe”:*

It intends to define policies, methodologies and instruments to improve the management of water resource, in order to better communicate and offer opportunities to investors, and to increase the interest of possible investors in minor scale electric systems.

The project is co-financed by the European Commission with the Intelligent Energy Europe 2006 programme.

- *Energetic Certification of buildings:*

Urban growth certainly offers development opportunities and it promises a better quality of life, but it also creates some environmental, economic and social asymmetries.

In the last few years, a renewal of the traditional environmental policies towards a certification, a priori, of building energetic sustainability has occurred.

The provincial project intends to constitute an Agency of energetic certificates validation (at present, the energy consumptions certification is devolved by the Region Lombardia upon individuals).

Strategic axis 4 – Welfare and social integration

Utenza Fragile @ Provincia di Cremona – RSA area (Healthcare residence) and people who are not self-sufficient

Agency for social inclusion

- *Utenza Fragile @ Provincia di Cremona – RSA area (Healthcare residence) and people who are not self-sufficient:*

It is divided in two actions:

“Q&E – Conjugating Quality and Efficiency in Cremona’s Healthcare residences”, with the goal of sharing services indicators, in the territory, in terms of quality and efficiency and good healthcare/management practices;

“LEPS –Livelli Essenziali Prestazioni Sociali (Essential Levels of Social Benefits)”, with the purpose of developing a LEPS system to access the services for people who are not self-sufficient in the province of Cremona.

- Agency for social inclusion:

It regards the creation of a body which can verify and understand territory needs and critical situations and, at the same time, which can propose and coordinate inclusion strategies for immigrant people.

It would represent the first case in Italy where the problem of integration is faced by a plurality of organizations involved.

Associazione Industriali of the province of Cremona and the Province of Cremona are promoters.

Other bodies involved are: the municipalities of the province, Ambiti Distrettuali of Cremona, Crema and Casalmaggiore, CCIAA of Cremona, Azienda Sanitaria Locale (local health unit) of the province of Cremona, Consiglio Territoriale per l’Immigrazione (Local council for immigration), Industries associations, Trade union Organizations, Forum Provinciale del Terzo Settore (Provincial forum for the tertiary sector).

Strategic axis 5 – Culture, Tourism and Creativity

Cre.Ar.T.E. – Cremona Crema Casalmaggiore Art Territory Economy: the evolved cultural district of the province of Cremona

District of Music- MUovere SINergie per lo sviluppo turistico Come Armonia (Moving synergies for tourist development like harmony)

Parco dei Monasteri

Waterways

- Cre.Ar.T.E. – Cremona Crema Casalmaggiore Art Territory Economy: the evolved cultural district of the province of Cremona:

The objectives are the strengthening of the activities of protection, conservation and improvement of the cultural heritage and the promotion of a sustainable use that can provide medium-long term benefits for the territory .

At present, the project is at its final stage of development with the goal of obtaining the important co-financing support from Fondazione Cariplo, available for the concrete phase of realization of the cultural district.

The total amount of the project is 8 million euros.

- District of Music - MUovere SINergie per lo sviluppo turistico Come Armonia (Moving synergies for tourist development like harmony):

It is a project of territorial marketing which intends to promote the tradition of the provincial territory in the field of music and the art of violin making; consequently, it qualifies, improves and integrates the offers of the territory and allows them to be shared. As far as the Tourism is concerned, a Memorandum of Understanding was signed by all the bodies involved.

The District of Music is not intended as an alternative to the Cultural District, but it is inserted into the musical sector provided for by the Cultural District itself.

- Parco dei Monasteri:

The project is an action of reclamation and improvement of an area in the existing cultural heritage.

The programme, which is made of several actions, is included in a specific reclamation plan and in an agreement (Accordo di Programma) among Region Lombardia, Municipal and Provincial Authorities, *Agenzia del Demanio* (government property agency), Soprintendenza per i beni architettonici e del paesaggio (agency responsible for monuments and landscape), Walter Stauffer foundation.

The project was included in Expo 2015 Technical Group. The total amount of the project is about € 49,263,000, deriving from the total of the different actions.

- Waterways:

It consists of two Progetti Integrati d'Area – PIA- (Integrated projects of area), one on the river Oglio and the other on the rivers Po and Adda, which include the integrated and complementary development of several typologies of operations (within environmental and cultural resources and assets are combined in a single long path designed on the province's rivers), concentrated in the same area and with a "supra-municipal" connotation.

The project is going to be nominated on Axis IV of ERDF. The deadline for the submission of proposals is at the end of May 2009. Each of the two projects needs 11 million euros.

Strategic axis 6 – Material and immaterial infrastructures

Hub of Cavatigozzi – Port of Cremona

Logistic intermodal terminal in the port of Cremona

Track doubling in the section Cremona-Cavatigozzi and section Cremona-Olmeneta

Tencara production centre

Implementing "Free flow" arrangement and hydraulic techniques for the River Po

Extension of M3 line from San Donato to Paullo

Goods yard of Casalmaggiore

- Hub of Cavatigozzi – Port of Cremona:

A solution has been considered in order to improve the capacity of the railway link.

Expected cost: 1.977 million euros.

- Logistic intermodal terminal in the port of Cremona:

The action synthetically consists of a "TRI-modal" Terminal (Water-Iron-Rubber).

The final cost of the action is about 12.950 million euros.

- Track doubling in the section Cremona-Cavatigozzi and section Cremona-Olmeneta
(improving the connections to Treviglio town and Brescia town):

They are highly critical situations. For the Cremona-Cavatigozzi doubling the cost is about 29 million euros; while the expected cost for Cremona-Olmeneta doubling is 50 million euros.

- Tencara production centre:

The area was assigned to production settlements and activities of goods transport and logistics, but it needs infrastructural operations.

The total investment varies from 25.2 million euros to 43.4 million euros.

- Implementing “Free flow” arrangement and hydraulic techniques for the River Po:

It consists of a flood reduction when the river is in maximum flood and an increase when the water levels are low, in order to allow the navigability of the river at least 340 days per year. For the first project the total amount is 77 million euros.

- Extension of M3 line from San Donato village to Paullo village:

It is a project that increases sustainable mobility along the road of main access from the province of Cremona towards Milan.

- Goods yard of Casalmaggiore:

Improvement of the structure in collaboration with the Municipality of Cremona, Province of Cremona and AIPO.

Results

Since the signing of the agreement (2007) up to now, ***the effort of involvement and consultation of the local actors has been carried on.***

The Pact represents a ***new method of work***, which leads to a ***change in outlook in the definition of the strategies of territory development***: from single, specific objectives to shared, well-constructed visions. ***This facilitated the start-up of the projects.***

Having an instrument of strategic planning offers opportunities of comparison on priority subjects and swiftness and facilitation in decisional projects; thus, it generates and strengthens local actors' ***learning*** and ***participation*** in the choices related to the territory.

Project monitoring and strategic evaluation

The Pact for Development in the Province of Cremona has started specific activities of strategic evaluation and project monitoring, for which a technical group of work has been created; the group is composed of one representative for each promoting body (Province of Cremona, Region Lombardia, CCIAA of Cremona, municipalities of Cremona, Crema and Casalmaggiore) and it is supported by Local Economy Laboratory (LEL) of Università Cattolica, branch of Piacenza-Cremona.

Evaluation and Monitoring unit

The Unit was officially recognized by the subscribers of the Pact during the Strategic Committee that took place on May, 26th 2008, in Crema.

The meeting of setting-up and starting-up of the activities took place on July 4th 2008, at the Pact for Development office. During the meeting, professor Rizzi, from the Università Cattolica, defined the activities of strategic evaluation and projects monitoring and presented the functions of the Unit.

The Unit should implement an activity of strategic evaluation, through a system of indicators that are appropriate to describe the socio-economic situation of the area and to analyze any possible changes, in order to provide a guidance for the territorial policies; moreover, it intends to create a project monitoring scheme, in order to verify their progress and realization and to evaluate their effects on the local system, with particular attention to work, in terms of quality of work, growth and professionalism, employment and consolidation of work relationships.

Contents of the Unit meetings

During the meeting of July 4th 2008 and the following ones, dated of 13th October and 10th November 2008, a proposal of a strategic evaluation scheme and of a projects monitoring

sheet were submitted and discussed: both proposals are the result of a work within the Pact for Development Office with LEL collaboration.

The necessity of possible modalities of integration and modification of the proposals developed was highlighted so as to avoid duplications with other instruments and to be able to realize an homogeneous evaluation structure which grants the optimisation of data retrieval.

Projects monitoring: modalities of work

Some hypotheses of monitoring were evaluated on the basis of the requests of CGIL, CISL and UIL about an in-depth examination of aspects related to work: after testing the first idea of technical sheet elaborated by the Pact for Development Office, with LEL support, a specific research project connected to the project “Innovation and competitiveness for micro, small and medium-sized enterprises (Innovation Call 2007)” was elaborated thorough direct contacts with the firms involved, in order to verify their degree of satisfaction and the results obtained with the fund assigned.

It is possible to indicate the consequences on employment and quality of work of projects that support the production structure only by examining individually and specifically each case. Moreover, a typology of analysis similar to that employed on “Innovation Call 2007” project is applicable only to some projects.

The Region Lombardia elaborated a monitoring programme for actions concerning public works. This model also regards projects belonging to typologies that are different from public works, with specific instructions.

Even by employing the sheets arranged by the Region, it appears that an in-depth analysis regarding the effects of the projects on work is only possible through focused and specific researches on the project examined.

Possible development for the strategic evaluation

With reference to the effects of the actions on the local system, it is possible to think of a system of strategic evaluation planned beginning from the Network of development of the Pact (coinciding with AQST’s lines of action), which could connect to documents of regional planning thanks to the location of common subjects and aims and to the choice of indicators that are homogeneous and, therefore, easily comparable.

2.1.1.4 The Pact and the young

Within the course of the Pact for Development in the province of Cremona, two surveys were carried out with regard to the world of the young.

The first one, carried out during 2007/2008 academic year, aimed to know young people’s expectations towards the development of the territory and, at the same time, to verify the hopes and the problems of the young.

The survey underlined the increasing anxiety about insecure employment and, therefore, the importance of a stable job. Health and welfare services, IT and telecommunication are the most appreciated sectors.

Unfortunately, the young showed very little confidence towards the political forces, while, on the contrary, they showed a certain openness towards scientists and entrepreneurs of small businesses. The survey also points out that the reality of Cremona is perceived as “static” from an economic point of view and also “closed”, where only appearance is worth and nothing new happens.

The meeting for presenting the results was also marked by the remarks of some teachers who underlined the importance of the dialogue between school and students that is necessary in order to improve career guidance, but particularly to help young people understand, already during their studies, their skills and their resources that can be useful in the world of work. There was also a dialogue between the young and the members of the Control Room of the Pact for Development, which pointed out that there is no shortage of projects for young people, but the real problem is the incapability of linking the interest of the young to the projects that regard them.

The survey also revealed young people's great desire for putting themselves to the test and realizing something important for the society. The young have ideas and clear objectives, they do not tend to conform with the few opportunities they are offered, but, on the contrary, they show to be full of new innovative ideas.

The second survey was carried out during 2008/2009 academic year thanks to the support of the Adviser for Equal Opportunities of the province of Cremona.

The survey dealt with equal opportunities and it revealed that the young, though they are not in the world of work yet, perceive a strong discrimination in this field, where there still are some prejudices about men and women's attitude to work in different sectors; indeed, 78% of the 1141 questionnaires states that it is different to be a man or a woman in the world of work. Moreover, 84% of the young declares that most of the differences of treatment occur at work. The evidence, which emerged during the final meeting where the results of the survey were presented, is that there should be no discrimination of gender or race where competences are required, both at work and at university, as well as in the family, where young people believe that the division of duties should depend on the time available for doing housework (which also have too deep-seated prejudices that still do not equally divide the roles). The survey shows that the main discrimination factor is always race (48.8% of the total questionnaires, compared to 36% of sexual orientation, 24% of handicap, 16% of religious belief).

2.1.2 The Environmental Energy Plan

2.1.2.1 Introduction

The environmental energy plan aims at organizing the energy sector from the point of view of the environmental aspects, indices of life quality and sustainability. Thanks to its potentials, it is adopted by many provinces, even though they are not obliged to, and thanks to the fact that its implementation is voluntary, the pilot projects that have been carried out still benefit from such flexibility that properly suits the features of the various local situations. The provincial environmental energy plan (P.E.A.P.), carried out by the Province of Cremona, stands out among the existing plans because it is conceived and carried out through an electronic medium and it consists of three tools: a data base, spreadsheets and a hypertext that can be consulted online; thus, the plan is easy to update, to go over, to modify and to use. The development of the plan was carried out within the scope of Agenda21: the involvement of all the stakeholders, from the planning stage through Agenda21 forums, has fostered both the support of the bodies, as regards data collection (also through interviews and questionnaires), and the adoption of the suggestions relating to local energy-environmental features that have better outlined the fields of research. The active participation assured a better spread of the results and citizens have become aware that they have taken part in a fact-finding and decision-making process. The plan, in agreement with the regional guidelines, aims at analysing the territorial situation, at assessing energy offer and demand, the environmental impact and the sustainability of its use, as well as at organizing the potentials of a more rational use of energy and of the reduction of pollution. The plan can be viewed at the following website address:

<http://www.provincia.cremona.it/settori/ambiente/peap2003/>

2.1.2.2 PEAP structure

The PEAP **cannot be imposed**, but rather **it is a tool to support the decisions that the Provincial Administration** is required to make, the opinions it is required to express to other territorial governmental bodies, and its own actions aimed at stimulating energy saving. Thus, on the one hand, the Plan provides a comprehensive picture of the situation, and on the other hand it allows quick assessments. Therefore, obviously, the plan shall be defined through an electronic medium that allows the widest consultation possible, the promptest updating and the most effective distribution. Furthermore, that same medium allows anyone to go over the assessment procedures and, as far as possible, it makes those same procedures transparent, in order to promote the participation and dialogue objectives planned by Agenda 21. The PEAP is defined as follows:

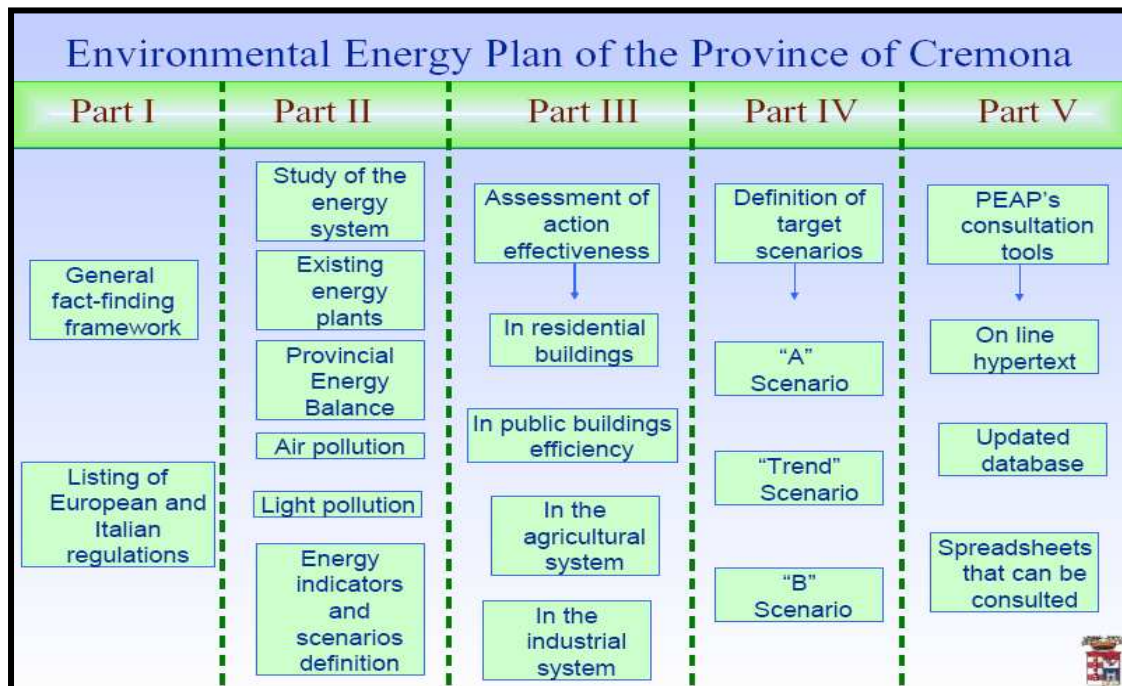

2.1.2.2.1 Part One: General Fact-Finding Framework

This section includes the description of the current provincial energy and environmental situation and, more precisely, a series of municipal and other data that, despite not concerning the province, wield a meaningful influence.

Listing of international and Italian regulations.

Acquisition and processing of the data necessary to define the physical and environmental, socio-economic, demographic and structural system of the Province for the subsequent analysis of the energy system. In particular, the morphology, the hydrography and the meteorology of the Province, the concentration of pollutants, the demographic indices, forests and the agricultural heritage, the production activities, the road network and transport, the existing provincial territorial and sectoral plans have been analysed.

2.1.2.2.2 Part Two – Analysis of the energy system:

Study of the local energy system

Acquisition and processing of the basic energy data as regards demand and offer, in particular starting from the sales data per energy carrier (thermal fluid, natural gas, fuel oil, LPG, Diesel oil, gasoline, electric power) and from the consumption data per sector (household, industry, agriculture, tertiary, transport).

Production plants and existing energy infrastructures

- ✓ Location and technical features of the main power plants of the province, including combined heat & power plants
- ✓ Methane distribution in the provincial municipalities
- ✓ Buildings owned by the province and relevant energy consumption

Drawing up of a Provincial Energy Balance (BEP)

The Balance has been drawn up per sectors and sources from 2000 onwards (if the data are available).

Assessment of air pollution

The pollution resulting from the energy system through the quantification of emissions per sectors and sources due to both point and non-point sources. In particular, using appropriate models,

- ✓ The calculation of polluting emissions with effects at local level (sulphur and nitric oxides, suspended dusts, etc.) and the relevant concentrations;
- ✓ The calculation of greenhouse gas emissions (carbon dioxide, methane)

have been carried out.

Light pollution

Preliminary analysis of the state of implementation of Regional Law no. 17/2000 in the municipalities of the province of Cremona. Drawing up of an information document describing the principles of law and comprising proposals for energy saving in the field of private and public lighting.

Definition of consumption trend scenarios

The indicators have been analysed in comparison with the main economic, demographic and structural variables (electric power per user in the household sector, electric power consumption per company and person in the production sectors, fuel consumption per vehicle). Energy consumption, as regards the main sectors, has been defined identifying two trends (high and low) for 2021 and the relevant environmental impacts, both at local and world level, of the Kyoto Protocol objectives. In particular, the scenarios have been achieved through the following steps:

- ✓ Processing of demographic and socio-economic projections and subsequent derived projections of energy consumption in the various sectors with different sources;
- ✓ Calculation of the scenario of future emissions starting from the projections of energy consumption;
- ✓ Assessment, through appropriate models, of the impacts of such emissions both at local (calculation of pollutant concentrations, possible acid precipitations) and world level;
- ✓

2.1.2.2 .3 Part Three – Assessment of feasibility and effectiveness of actions

Possible actions have been defined and quantitatively assessed through merit indices; such actions regard:

- ✓ The residential buildings;
- ✓ The energy efficiency of buildings: analysis of the current situation and assessment of saving opportunities in order to work out standard "building regulations", developed according to the criteria of the Agreed Code, and to distribute them to the Municipalities;
- ✓ The industrial and agricultural system, with special reference to the actions for the rational use of energy, such as the use of biomasses and cogeneration;
- ✓ The buildings of the public administration (schools, hospitals, etc.);
- ✓ Heat Management: the activity consisted of a preliminary assessment of the buildings owned by the Municipality and of the proposal and distribution of a standard "heat management" system to all Municipalities;

- ✓ The assessment of the actions will take place also using specific sustainability indicators, such as the ecological footprint (or exergy), the avoided damage, the morbidity and mortality indices;
- ✓ The monitoring of the PEAP will be carried out also through the setting up of the Energy Forum supervised by the Provincial Office Agenda21.
- ✓

2.1.2.2.4 Part Four –Target scenarios

Definition of the overall target scenarios in the various sectors by 2021 consequent to the identified actions, with the assessment, in energy and environmental terms, of the reduction of consumption and emissions compared to the corresponding trend scenarios by 2021 and to the current consumption and emissions. Such comparison will be easily extensible to different scenarios, thanks to the implementation modes described in part five.

2.1.2.2.5 Part Five – Management tools

The plan consists of:

- ✓ A hypertext, comprising all the regulations, the descriptions and the critical results which make it immediately available for consultation and distribution, basically through the internet;
- ✓ A database, comprising the information relating to the current situation of the Municipalities in the province, so that such information can be easily found and in the future it can be easily updated;
- ✓ Spreadsheets that allow to easily go over the assessments carried out, changing the parameters if necessary, and making the comparison among the various alternatives easy.

This information structure assures the effortless consultation and maintenance of the Plan, as well as the possibility to go over the assessments.

2.1.2.3 Meetings and works that led to the drawing up of the energy plan

In 2003, **four meetings** took place at provincial level in which about **70 delegations** representing the industrial, agricultural and business sectors of the provincial territory participated (public bodies, private and public trade associations and investors). The four meetings always started with a speech by the Milan Polytechnic, which described the activities carried out and proposed ideas, solutions and actions for the various energy sectors, and ended with extensive debate sessions.

On 21st March 2003, the first meeting took place: during that meeting the Milan Polytechnic, in charge of extending the PEAP, described all the planned steps that would lead to the approval of the final draft of the Plan and highlighted the method used to draw up the PEAP: a structure based on an electronic medium, small and easy to find, consult and update.

On 29th May 2003, the Milan Polytechnic outlined the salient aspects of the general fact-finding study carried out on the components of the territory directly linked to the energy issue:

- ❖ The demographic data showed an average 2% population growth during the 1991-2001 decade with an ageing degree higher, especially in the chief town, than the national and regional data, family units became smaller but the number of houses increased by about 9% with possible effects on household energy consumption. From 2003 to 2010 Regione Lombardia expects a decrease of 25,000 units, excluding immigration phenomena;

- ❖ As regards the climate, wind is too insufficient to be exploited for electrical purposes whereas the features of solar radiation suggest it should be more widely used in the photovoltaic and thermal field;
- ❖ As regards production activities, the trend shows a reduction of the people working in the industrial sector in favour of the tertiary sector, and the agricultural field witnesses a decrease in the cultivated surface, yet lower than the decrease of farms, which, in the vast majority, are still family-owned;
- ❖ As regards transport, the assessment of the fleet of cars emphasizes an increase in the number of per capita vehicles which is not matched by a similar increase in fuel consumption, probably due to the incentives to buy environmentally-friendly motor vehicles;
- ❖ As regards the energy balance, whose central issue is the historical trend between demand and offer of energy carriers divided per production sectors, the demand for electric power widely increased over 70% during the last decade and well above the national and regional average. This surely indicates economic liveliness, but it may also conceal an inefficient use of the resource;
- ❖ As regards offer, the energy production of the province was judged limited to too few plants whose features have not yet been inventoried. A potential renewable energy source, which has been the subject of a detailed study, is the biomass deriving from agriculture and wood industry. Such activities may make 250,000 tons/year of residual dry matter available and exploitable in combined heat and power plants.

After the speech by the Polytechnic, the company Ecosistemi from Rome, that was in charge of spreading the Strategic Environmental Assessment (V.A.S.), described the various steps of the VAS, seen as the main tool to operationalize the concept of sustainable development and to help the political decision-makers to opt between environment-compatible alternatives and natural resources. The aim is to contribute to the integration of the environmental considerations in the plans and programmes at the draft stage, similarly to what happens for economic and social considerations. The technical-methodological layout of the VAS is comprised in Directive 42/2001/CE which has not yet been adopted in Italy; if the province of Cremona applies it to the Energy Plan, it would become a pioneer in the safeguard of the territory and life quality.

On 9th October 2003, the Milan Polytechnic, through three hypothetical development scenarios, explained how the environmental and territorial consequences of energy choices can be simulated:

- ❖ The “trend” scenario does not presuppose fundamental changes in a twenty-year projection: population, consumption and production will follow the current trend. A hypothetical use of 50% of the production areas described by the PTCP (Territorial Plan of Provincial Coordination) is expected and new energy will come from the development of the AEM district heating network and from a wood biomass plant. 80% of the existing mini hydro power plants are expected to be put back into service, the photovoltaic power is expected to increase by 6,5% annually and 23% of the cattle and pig farms are expected to use biogas cogeneration plants. This scenario is in-between, the other two scenarios are more extreme;
- ❖ The second “A” scenario assumes a growth in energy consumption as expected by the Regional Energy Programme, with the maximum expansion of production activities that will cover 100% of the area indicated in the PTCP (Territorial Plan of Provincial Coordination), including the 400MW power plant with district heating and a reduced use

of renewable sources (a hydro power plant in Genivolta, 3% of biogas exploitation, only an additional 0,5% of photovoltaic power are considered);

- ❖ The last “B” scenario assumes a strong drop in consumption, the use of renewable sources, a moderate development of the production sector if the energy intensity will not change. A higher number of biomass plants are expected to be used through the switch of all the available land to energy crops, hydro power plants are expected to be 100% put back into service, biogas is expected to be around 28%, photovoltaic power is expected to increase by 15% annually and 3,15% of the houses are expected to undergo high-efficiency energy refurbishments. The scenario parameters have been set in order to cause, by 2010, a reduction of CO₂ emissions by 6.5% compared to 1990 emissions, as provided for by the Kyoto Protocol.

On 28th November 2003, the last PEAP Forum took place and the final draft of the Provincial Environmental and Energy Plan was presented together with the possible actions to undertake in order to carry out the forecasts. The Milan Polytechnic highlighted that in the light of the remarks of the previous debates and in the light of the continuous dynamics of demand and offer indices, **a “fourth” reference scenario for the provincial energy planning was chosen: it represents more or less the trend of provincial consumption, which is growing as a whole both in the production and residential sector, yet with a strong drive towards the rational use of energy and the exploitation of local renewable sources.** Thanks to the latter, in particular to biomass plants and mini hydro power plants, the CO₂ emissions estimated by 2010 may have been in line with the Kyoto Protocol objectives and, even though the power deficit was high, however it would have decreased from 92% in 2004 to 83% in 2021.

On 17th December 2003, the Council of the Province of Cremona adopted the remarks collected during the debates organised in the previous meetings and approved the PEAP by council resolution no. 176.

In 2008, the Province of Cremona charged the Milan Polytechnic again with the task to carry out an **update** of the Energy Plan, that was drawn up five years before; such activity ended up in the approval of the new document by the Provincial Council with **Resolution no. 68 dated 22nd April 2009.**

2.1.2.4 Actions undertaken

According to the resolution of the Provincial Council no. 176 dated 17th December 2003 that approved the PEAP and all attached documents, the following priority actions have been carried out:

2.1.2.4.1 A) Mini Hydro Power

A.1) Forum On Mini Hydro Power: the Forum was called on 24th May 2004 in order to present an interesting and easily accessible opportunity to produce energy, considering the remarkable abundance of water of the province and the number of mills and factories already existing on the territory. Even though each “mini hydro” plant has a limited power, as a whole they can become very numerous and thus contribute, even though not solve, to the coverage of national electric power demand in a non negligible way. Moreover, the use of mini hydro power stands out also from the environmental point of view, because the building and organizational features of small hydro power plants have poor impacts on the territory. New sector-specific stakeholders, such as Land Reclamation Consortia, Irrigation Consortia and the Po River Interregional Authority, were invited to the meeting with the aim of finding an

agreement for the exploitation of the rivers and the channels of the territory for hydroelectric purposes. The remarks collected during the meeting highlighted the existence of at least 10 important sites for mini hydro power production and of several micro hydropower heads (old mills to put back into service) to check and, in case, to modernize.

A.2) Institutional Activity Of Water Use Granting: The “fruits” of the over-mentioned forum, along with the continuous promotion activity carried out by the “Energy” department, consisted in convincing the investors that the provincial territory could offer real potentials in hydroelectric terms. Actually, from 2003 to 2009, the private investors have submitted 23 new concession applications to use water for hydroelectric purposes and the situation of the concessions granted or under examination due to “competition” issues is as follows:

municipality	diverted water body	GIS coordinates	capacity (kW)	annual production capability GWh/a	examination stage
Genivolta	Drainage Channel – flowing into Oglio	x 1570226 y 5021033	753,7	4,5	Granted in 2005
Crema	Serio River - Palata Borromea	x 1554901 y 5024444	662	7,4	Granted in 2007
Montodine	Serio River	x 1555797 y 5014677	550	3,8	Granted in 2007
Bagnolo Cremasco	Comuna Irrigation Ditch	x 1548773 y 5023640	82,35	0,58	Granted in 2007
Crema	Cresmiero Irrigation Ditch	x 1553420 y 5023047	176,05	1,2	Granted in 2007
Spino d'Adda	Adda River - at Canadì -	x 1536174 y 5027734	2998	13,7	Under published examination
Pizzighettone	Serio Morto Drain Ditch – flowing into Adda -	x 156298 y 5004128	323,52	2	Under published examination
Isola Dovarese	Oglio River	x 1603443 y 5003670	1002	6,8	Under published examination
Isola Dovarese	Oglio River	x 1603443 y 5003670	2255,93	14,38	Under published examination
Gombito	Serio Morto Channel- flowing into Adda -	x 1556836 y 5012389	60	0,53	Under published examination
Ricengo	Serio River - Palata Menasciutto -	x 1555783 y 5027828	349,41	2,7	Under published examination

Ricengo	Serio River - Palata Menasciutto -	x 1555783 y 5027828	391,06	2,7	Under published examination
Sergnano	Serio River - Palata Babbiona -	x 1555585 y 5030866	313	2,3	Under published examination
Casale Cremasco Vidolasco	Serio River - Palata Babbiona -	x 1555585 y 5030866	277,37	1,9	Under published examination
Casale Cremasco Vidolasco	Serio River - Palata Malcontenta -	x 1555847 y 5029970	310,2	2,3	Under published examination
Casale Cremasco Vidolasco	Serio River - Palata Malcontenta -	x 1555847 y 5029970	350,73	2,03	Under published examination
Crema	Vacchelli Channel	x 1554560 y 5024172	122	0,82	Under published examination
Cumignano sul Naviglio	Naviglio Grande Pallavicino	x 1565631 y 5022674	102	0,66	Under published examination
Cumignano sul Naviglio	Naviglio Grande Pallavicino	x 1565555 y 5021943	174	1,01	Under published examination
Cumignano sul Naviglio	Naviglio Nuovo Pallavicino	x 1565780 y 5022308	61	0,4	Under published examination
Dovera	Chinola Vecchia e Dovarola	x 1543091 y 5022434	10	0,05	Under preferential examination
Rivolta d'Adda	Adda River	x 1536000 y 5037000	459	2,08	Under published examination
Rivolta d'Adda	Adda River	x 1538748 y 5035795	919,12	6,4	Under published examination

A.3) European Smart Project (Eie/07/064): the provincial offices, during the clearing of the first paperwork regarding water use concession for hydroelectric purposes, have noticed a problem that slows down the spread of small plants in the provincial as well as national territory. In Italy, the regulations that govern the grant of water use concessions for small hydro power plants are the same that govern the grant of concessions for large-scale plants. For all practical purposes, this is a disadvantage, because a company that wants to build a small hydro power plant must submit a huge number of technical documents whose costs are often comparable with the already small income resulting from the sale of electric power. Thus, it was decided to participate in the 2006 E.I.E. European Call with the SMART project: the aim was to compare the Italian regulations on hydropower with those of other European countries and see if they have examples of current procedures that may also be introduced in

Italy, and to make the Italian legislative bodies aware so that they approve corrections to the laws in force, in order to reduce the burden of the administrative steps as regards the authorizations of small hydro power plants. The project, started in 2008 and lasting three years, is led by the Province of Cremona; the partnership is made up as follows:

- ❖ CESI Ricerca spa, Milan, Italy;
- University of Zagreb, Faculty of Mechanical Engineering and Naval Architecture, Zagreb, Croazia;
- ❖ Karlovac Regional Authority, Karlovac, Croatia;
- ❖ The Norwegian University of Science and Technology, NTNU, Trondheim, Norway;
- ❖ Regional Secretariat of Attica, Athens, Greece;
- ❖ Energieagentur Waldviertel No-Profit Agency, Thaya, Austria.

The over-mentioned players are still involved in the study of the local regulations that govern the administrative procedures of water diversion concession for hydroelectric power production and in spotting the strength and weaknesses of each regulation.

2.1.2.4.2 B) Energy Exploitation of Biomasses And Biogas

B.1) Provincial Waste Plan – Organic Fraction Of Waste: according to the Provincial Waste Management Plan, under approval by the Region, the compostable fraction deriving from selective collection is separately managed in dedicated energy recovery and composting plants. Presumably, by 2011, once regularly running, the plant requirements regarding the compostable fraction, calculated taking into account the selective collection targets set for each area, will be:

- D. Cremona Area: 18,125 t;
- E. Crema Area: 24,377 t;
- F. Casalasco Area: 5,804 t.

Therefore, as regards the organic fraction of municipal waste, estimated a little below 50,000 t/y, and sent to the composting plants located on the provincial territory, the following plant requirement is expected:

- G. Green waste composting plant with a capacity of about 25,000 t/y, in consideration of 2006 green waste production (mowing and vegetable material) estimated at 22,620 t and anaerobic digestion plant receiving about 20,000 t/y of Organic Fraction of Municipal Solid Waste (OFMSW) produced. Following the process, a finishing process is advisable;
- H. Composting plant with capacity equal to 50,000 ton/y receiving the organic fraction of municipal waste;

Options a) and b) shall be considered as alternative options. However, the Plan shall be open to the assessment of plants employing new technologies (for example molecular dissociation, ...), run or proposed by Municipalities or Joint Enterprises, up to a maximum capacity of waste disposal/energy recovery equal to 25,000 ton/y.

B.2) Feasibility Study on a Biomass Plant Network: a feasibility study on a cogeneration plant network supplied with wood biomass has been drawn up and has highlighted the real “potentials” of the Cremona territory to host 10 1MWe wood biomass plants with their relevant supply basins.

B.3) Design of a Plant Producing Power From Energy Crops: a feasibility study on a cogeneration plant supplied with energy crops has been drawn up and has highlighted a “real” potential of the Cremona territory to host at least one 500 kWe demonstration plant.

B.4) Forum on the Energy Exploitation of Livestock Effluents: the Forum on the energy exploitation of livestock effluents started on 29th September 2004, hinging around the chance that the farms on the territory had to start exploiting the biogas deriving from effluents. A

relevant study worked out within the PEAP has highlighted that most pig and cattle farms of the province have the right size (over 3,000 head) to make the installation of a livestock effluent treatment plant economically interesting, thus allowing to recover a considerable amount of biogas to use for heat and power generation. One of the main targets of the Forum was to exploit the active dialogue among the stakeholders participating in the works to set up an agreement between the farms, the provincial administration and the trade associations in order to foster the installation of plants for biogas production through anaerobic digestion at the pig farms.

B.5) Forum On Biogas: it was held on 17th June 2005 and it was organized by the Province of Cremona in order to involve all the interested stakeholders in an active debate according to Agenda 21 model. The fundamental target of the Forum was the need to give a real institutional support to those operators who want to produce energy through renewable sources.

B.6) Institutional Activity: Authorization of Biogas Plants: the “fruits” of the over-mentioned forum, along with the constant promotion, carried out by the provincial offices, to use biogas, consisted in convincing the investors that the provincial territory could offer real potentials in agroenergetic terms. From 2003 to 2009, the provincial offices have approved 16 new authorization applications to build biogas plants, as specified in the table:

LIST OF PLANTS THAT PRODUCE ENERGY FROM BIOGAS

Company's name	municipality	supply type	C in kW
Power Green S.r.l. Viale Europa, 6 58100 Grosseto	Castelleone	Agricultural waste biomasses	1000
Agricola Lameri C.na Tera di Casso 26012 Castelleone	Castelleone	Livestock effluents and agricultural waste biomasses	500
Az. ag. Spoldi Giacomo Cascina Brugnole, 3 26018 Trigolo	Trigolo	Livestock effluents	70
Az. ag. Inzoli Domenico C.na Rinetta 26025 Pandino	Pandino	Livestock effluents and agricultural waste biomasses	500
Az. ag. Medeghini Via Cortine, 2 Mazzano (BS)	Pandino	Livestock effluents	80
Agrienergia S.r.l. Loc. San Giorgio 26027 Rivolta d'Adda	Rivolta d'Adda	Livestock effluents and agricultural waste biomasses	400
Sageter Energia S.p.A. Via XXV Aprile, 18 25038 Rovato (BS)	Malagnino	Dump biogas	1600
Az. ag. Bertesago Pietro Via Roma, 89 26010 Moscazzano	Moscazzano	Livestock effluents and agricultural waste biomasses	560
Pieve Ecoenergia s.c.a. Via Marconi, 33 26010 Cingia de Botti	Cingia de' Botti	Livestock effluents and agricultural waste biomasses	1000

Az. ag Corte Grande s.a.s. Via Novelli, 9 24122 Bergamo	Casaletto di S.	Livestock effluents and agricultural waste biomasses	330
Az. ag. Maestroni Mario C.na Valli, 2 Pizzighettone	Grumello Cr ed U.	Livestock effluents and agricultural waste biomasses	1000
Az. ag. Podereto Via Regina della Scala, 2 26020 Soncino	Ricengo	Livestock effluents	330
Agrosocietà di Rinaldi A.P.C. Via San Bassano, 7 26020 Formigara	Formigara	Livestock effluents and agricultural waste biomasses	3000
Az. ag. LE GERRE di Rinaldi loc. Le Gerre Crotta d'Adda	Crotta d'Adda	Livestock effluents and agricultural waste biomasses	2000
Az. ag. SOBAGNO loc. Ceramica 26030 Gabbioneta	Gabbioneta B.	Livestock effluents	70
Az. ag. Lanfredi Luciano C.na Fienile del pesce 26020 Acquanegra Cremonese	Acquanegra Cr.	Waste and livestock effluents	100
LATTERIA PLAC	Persico Dosimo	Sewage sludge	180
LATTERIA CA' DE STEFANI	Vescovato	Sewage sludge	90
Pizzamiglio F.lli soc. ag. C.na Castello 26015 Soresina	Soresina	Livestock effluents and agricultural waste biomasses	1000
Agrigreen s.c.a. Via Breda, 16/B 26036 Rivarolo del Re	Rivarolo del Re	Livestock effluents and agricultural waste biomasses	1000
Scarani P. Giorgio Via Fosio 2 Villongo (BG)	Pieve d'Olmi	Livestock effluents and agricultural waste biomasses	1000
Az. ag. Avogadri Marco Maurizio e Luigi Mario Via Regina della Scala, 2 26029 Soncino	Romanengo	Livestock effluents and agricultural waste biomasses	1000
Soc. ag. Palazzetto s.s. Via Folli, 2 26023 Grumello Cremonese	Grumello Cr ed U.	Livestock effluents and agricultural waste biomasses	1000
Az. ag. Poli Marco e Giuseppe Via Montegrappa, 13 26030 Gadesco Pieve Delmona	Gadesco P.D.	Livestock effluents and agricultural waste biomasses	250
Soc. ag. Horti Padani Via Po 26040 Pieve d'Olmi	Pieve d'Olmi	Livestock effluents and agricultural waste biomasses	1000
Biofor Energia S.r.l. Via del Commercio, 29 26013 Crema	Castelleone	Waste and agricultural waste biomasses	1600
Az. ag. Poli Marco e Giuseppe Via Montegrappa, 13 26030 Gadesco Pieve Delmona	Pieve San Giacomo	Livestock effluents and agricultural waste biomasses	100

Az. ag. Spring Farm C.na Fienili 26010 Castel Gabbiano	Castel Gabbiano	Livestock effluents and agricultural waste biomasses	180
Az. ag. B.T.C. S.r.l. Via IV Novembre 2 25100 Brescia	Castelverde	Agricultural waste biomasses	1000
Sant'Elena Energia S.r.l. Via delle Industrie, 11 Lana (BZ)	San Daniele Po	Livestock effluents and agricultural waste biomasses	1000
Installed power (MW)			22,94
Annual energy production (MWh)			17205
Annual energy production (MWh)			0

LIST OF PLANTS THAT PRODUCE ENERGY FROM BIOMASSES

Company's name	municipality	supply type	C in kW
Az. ag. Telò Massimiliano Via Palazzina, 2 26024 Paderno Ponchielli*	Paderno P.	Syngas from wood biomasses	70
Soc. ag. Corte Bernuzzo Via Giuseppina, 28 26030 Solarolo Rainerio	Solarolo Rainerio	Crude vegetable oils	200
Confezioni Santi S.p.A. Via regina della Scala 11, 26029 Soncino	Soncino	Crude vegetable oils	350
Soc. ag. Pandolfa C.na Pandolfa 26028 Sesto ed Uniti	Sesto ed U.	Crude vegetable oils	430
SANECO Via Giuseppina 3 26048 Sospiro	Sospiro	Crude vegetable oils	430
FER POWER1 S.r.l. Via Brignano 49 24047 Treviglio	Offanengo	Crude vegetable oils	430
ELCOS S.r.l. S.S. 234 km 58,250 26023 Grumello Cremonese ed Uniti	Grumello Cr ed U.	Crude vegetable oils	430
Soc. ag. Duchi F.lli C.na Cà de Farina Via Pasubio, 28 26030 Gadesco Pieve Delmona*	Gadesco P.D.	Syngas from wood biomasses	1000
Ricerca e Sviluppo Bioenergie Via Staffolo, 56 26041 Casalmaggiore *	Casalmaggiore	Syngas from wood biomasses	1000
Europea S.p.A. Via Provinciale 455 24059 Urgnano*	Isola Dovarese	Crude vegetable oils	1500
Martignana Po Energia S.r.l. Via Pasubio 5 24044 Dalmine *	Martignana Po	Crude vegetable oils	19000
Bioenergia Investimenti S.p.A. Via Gardale, 24 25036 Palazzolo sull'Oglio (BS)*	Solarolo Rainerio	Wood biomasses	15200
Installed power (MW)			24,84
Annual energy production			186300

2.1.2.4.3 C) Energy Saving in Public and Private Buildings

C.1) Drawing Up a Register of Thermal Plants: The Province is in charge of supervising the emissions and the energy efficiency of the thermal plants of all the Municipalities of the province, except for Cremona. In particular, the Provincial Administration checks the state of repair and the observance of the rules on energy saving of all thermal plants through assessments carried out by skilled technicians and the management of the declarations that state that the plants have been maintained.

Following the issuing of Legislative Decree 192 of 2005, of the Regional Law no. 24 of 11th December 2006, and finally of the Regional Resolution no. 5117 of 18th July 2007 “Provisions on running, supervision, maintenance and inspection of thermal plants on the regional territory” as amended and supplemented, the offices had to change and reorganize the “project of the inspection campaigns of the thermal plants” (the last bill adopted was the D.C.P. – Provincial Council Resolution - no. 142 of 2008). The new management presupposes the constant implementation of a new SINGLE REGIONAL REGISTER OF THERMAL PLANTS – “CURIT”. From 1998 up to today, about 20,500 inspections to thermal plants have been carried out, out of a total of about 100,000 plants estimated in the territory. Legislative Decree 152/06, “Environmental Consolidation Act”, governs the authorizations regarding air emissions of thermal plants beyond the threshold (3Mw for gas and LPG plants, 1Mw for Diesel oil plants). The authorization procedure requires a starting step, the conference of the concerned bodies and the issuing of the authorization decree with relevant inspections and surveillance.

C.2) Province&Municipality Protocol on Town Planning Regulations: Regione Lombardia imposes that buildings undergo energy certification and it is organizing the register of certification experts, the register of certified buildings and the calculation and certification procedures. Regione Lombardia will coordinate the awarding of the energy plates issued by the Municipality according to what has been declared by the qualified designer engineer. The project of the Province of Cremona, Environment Department, aims at offering the Municipalities the necessary technical assistance for the uniform coordination of the changes to carry out to the Technical Implementation Rules of Municipal Building Regulations, proposing a logical system of incentive policies. A draft proposal of the potential changes to the Technical Implementation Rules of Municipal Building Regulations has been drawn up.

C.3) FORUM “Municipal Contracts for Energy Management”: it was held on 22nd October 2004 and it gave the chance to present the new activities to mayors and involve the territory in some really feasible topics concerning energy saving. In this framework, the “Papers on the Provincial Environmental Energy Plan”, “Energy Efficiency in buildings: good sustainability practice” and “Light pollution: issues, resources, tools” have been presented. The two monographs, accompanied by a CD Rom, comprise regulations, information, examples of good practices for a more aware use of light and energy.

C.4) “Mi Illumino Di Meno” CAMPAIGN (I light up less): *M'illumino di meno* is the most important awareness and communication campaign dedicated to Energy Saving at international level. It was developed and launched by Caterpillar (a famous radio programme on Radio2), that on 16th February 2005, on the anniversary of the coming into force of the Kyoto Protocol, called the First National Day of Energy Saving; the Day has been repropo-

every year since then with ever increasing success. The philosophy of the Day is to convince as many people as possible to devote themselves to saving, which is the greatest energy deposit available now and for free. On the occasion of the fifth international campaign on the reduction of electric power consumption "*M'illumino di meno 2009*", the day dedicated to energy saving was 13th February from 6 pm. The aims of the campaign are:

- * to fight against world climate changes;
- * to reach even the citizens that are less sensitive to environmental topics through a particularly visible action;
- * to bring to the fore in the media the theme of energy saving through simultaneous and spectacular switching offs;
- * to stimulate a more widespread bottom-up participation so that everyone feels involved in an important personal contribution towards virtuous changes in energy consumption.

C.5) Deep Project: DEEP, Dissemination of Energy Efficiency Measures in the Public Buildings Sector is a European project financed within the E.I.E. programme of the General Directorate of Energy and Transport. The fundamental aim of the project, that started in January 2005 and finished in June 2007, was to promote opportunities to improve energy efficiency through the adoption of high environmental standards in public buildings.

The Province of Cremona, Environment Department, participated in DEEP as partner with 7 other players, under ICLEI coordination:

- ❖ IFZ- Inter-University Research Centre for Technology, Work and Culture (Austria);
- ❖ SEMCO – Swedish Environmental Management Council (Sweden);
- ❖ EPTA Ltd (Greece);
- ❖ University of Reggio Calabria (Italy);
- ❖ DIBA - Diputació di Barcelona (Spain);
- ❖ TEDKNA - The Local Union of Municipalities and Town Councils of Attica (Greece);
- ❖ Auxilia (France);
- ❖ Ecoserveis (Spain);
- ❖ Växjöhem AB (Sweden).

Website: http://www.provincia.cremona.it/servizi/ambiente/gpp_net/?ss=16&sv=82&sa=305

2.1.2.4.4 D) Promotion of Photovoltaic Power

D.1) Ideas Competition for the Recovery of a Former Municipal Waste Dump: the project was conceived with the aim to recover the former dump at Corte Madama in Castelleone (CR), an area now compromised from the environmental point of view but that may still have a useful role as an area for the production of environmentally-sustainable energy which would derive from the Sun. From a degraded place it may be transformed, through the installation of a photovoltaic plant and the building of an educational area for schools, and become a source of pride and of excellence for the provincial territory. The aim is not only to optimize energy production, but also to produce culture and knowledge, both in the technical-scientific field and in fields such as environmental and natural sciences and humanities. That is why in 2008 the Province of Cremona announced an ideas competition for carrying out the over-mentioned works; the competition ended on 7th April 2009 with the announcement of the winning project (D.G.P. – Provincial Council Decree - no. 205/2009). 13 private firms took part in the competition from all over Italy and, even though some projects diverged from the general average, the vast majority of the submitted “ideas” proposed a 400 kW plant, on a required surface of 3,400 square metres and 500,000 kWh of energy produced annually.

2.1.2.4.5 E) Setting up a Provincial Office for the Public

In the 2003/2004 two-year period, in order to facilitate the carrying out of the over-mentioned actions and the authorization of plants for the production of electric and thermal power distributed on the territory, the Province of Cremona created a special office called “Energy”, made up of technicians, with the aim of processing the files regarding the exploitation and production of energy both from conventional sources and from renewable sources, as well as the files regarding energy saving.

2.1.2.4.6 F) Conferences

F.1) Conference on "Renewable Energy Sources in the Plain": the round-table conference on the renewable sources for a comparison of experiences and opportunities on the topic of sustainable energy was held at the Sala Teatro Leone of the Municipality of Castelleone on 11th November 2005. Some experiences on the implementation of plants for the production of renewable energy have been presented. The Rinaldi Farm told their experience with biogas, emphasizing the energy saving and the additional income obtained thanks to the commissioning of the plant, then Marco Lorenzi from Genhydro talked about the mini hydro power plant at Genivolta that exploits a low-flow water head but produces energy equal to the consumption of 2143 families with a reduction of carbon dioxide emissions by 7,500 t/y. Marco Antoniazzi from the Province of Cremona talked about the results of the 2005 call for funding for the building of photovoltaic plants and presented the latest developments as regards the call for grants for next year. Finally, Fabrizio Cremaschini, from Aspm Soresina, explained the introduction of district heating in Soresina, and highlighted the great interest of the authority towards renewable sources. A lively debate then started and several people from the public spoke, among which trade associations (National Association of Young Farmers, Association of Young Industrialists, CCIAA, Association of Craftsmen), Legambiente, AEM, CNER, Banca Popolare di Cremona, Milan Polytechnic, Università Cattolica and ENEL.

F.2) Conference on "The sustainable requalification of the territory. Sharing, participation, local networks for sustainable development in the building sector": the conference on "The sustainable requalification of the territory. Sharing, participation, local networks for sustainable development in the building sector" was held on 7th June 2005; it was organized with ANAB on the topic of sustainability and energy efficiency introduced by the development of organic architecture and ecological design. The conference analyzed the properties of this new type of building, highlighting the need to improve the quality standards, to spread the use of biocompatible materials, as well as to keep consumption and environmental emissions under control. At the same time, the debate gave rise to possible new developments for the local economy. During the round table that followed, the debate focussed on the opportunity to create a reference body in charge of the promotion, spread and certification of organic architecture and ecological design.

F.3) Conference on "Energy efficiency in public buildings. Experiences and proposals": it was organized by the Agenda 21 Department of the Province of Cremona, the Energy Department of the Province of Bologna and "End-use **Efficiency** Research Group" of the Milan Polytechnic; the conference, held on 27th April 2005, focussed its attention on the development of strategies and actions to implement low energy consumption in public buildings, as directive 2002/91/CE on energy efficiency in the building industry states. In particular, the meeting introduced actions that have been already carried out or that are under way and that face these issues with a new approach, whose aim is to start a dialogue among

the players in the sector. The Province of Cremona explained the actions of the Administration on energy efficiency, the heat management contract and the Environmental Energy Plan. Nicola Labanca and Andrew Pindar of the Milan Polytechnic presented the PICOLight project to finance energy efficiency investments by public bodies. The conference was organized in the framework of another project co-financed by the European Commission, one of whose partners was the Province of Cremona: the over-mentioned DEEP project.

2.1.2.5 2009 Results and Updates

In 2008, the Milan Polytechnic was once again given the task of updating the PEAP five years after it was adopted and in the light of consumption dynamics and energy demand that, in general, in the last few years, have increased. The adoption of the “fourth” scenario in 2003, during the drawing up of the Plan, and of the over-mentioned undertaken actions allowed to achieve encouraging results from the point of view of the promotion and exploitation of renewable sources in the provincial territory. As shown in the following graph, from 2003 to 2008, the amount of energy produced by renewable energy sources (FER), highlighted in blue, underwent a constant growth:

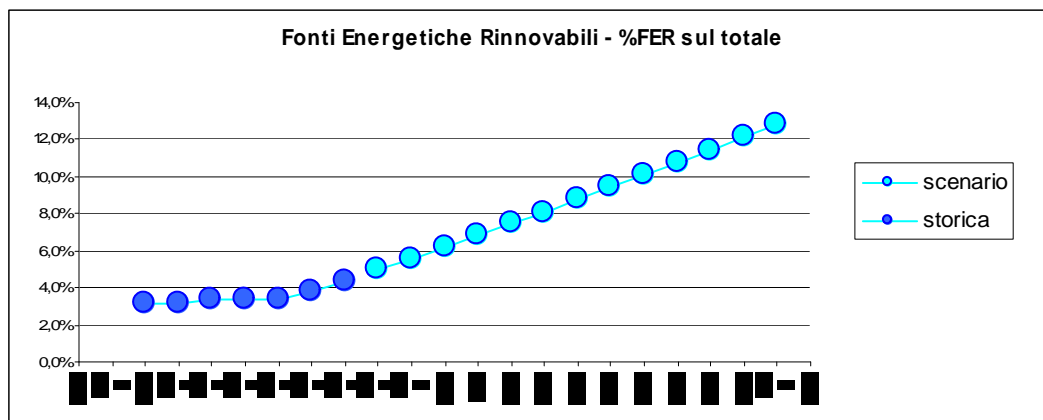

Legenda: Renewable energy sources - % out of the total
Scenario - historical

The estimated trend of that same amount of energy produced by renewable energy sources (FER) is highlighted in light blue along with a perfect historical evolution of the scenario chosen in 2003, without taking into consideration real unexpected occurrences or deviations. Unfortunately, less encouraging results emerged as regards CO₂ emissions and total consumption that show the following trend:

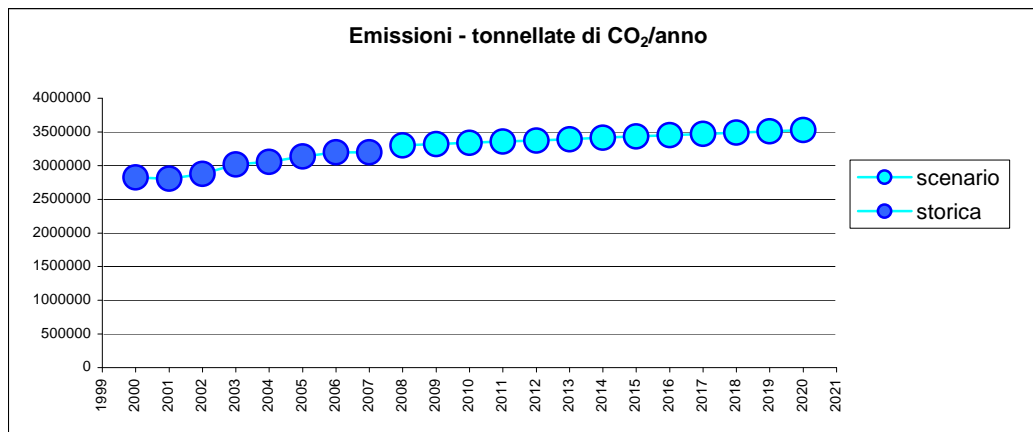

Legenda: emissions – tons of CO₂/y
Scenario - historical

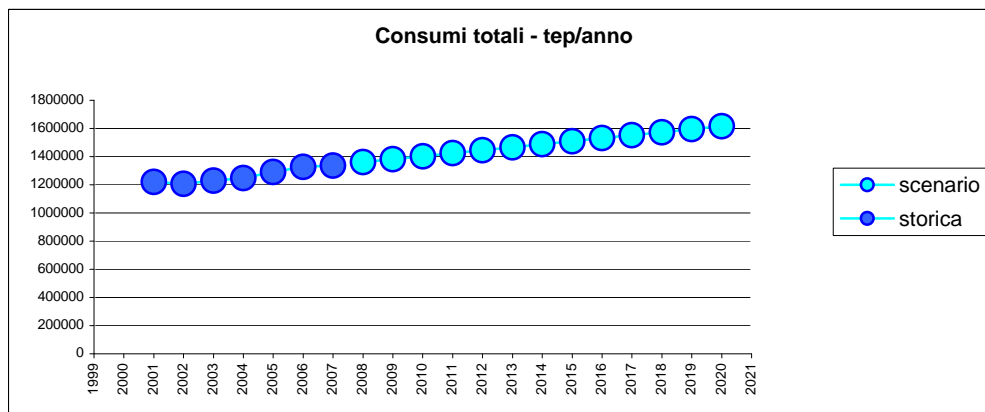

Legenda: overall consumption – tep/year
Scenario - historical

Further to the over-mentioned trends, the Polytechnic thought it was advisable to study and propose two new scenarios to adopt so that the CO₂ emission trend could be reversed. In order to define the prospects of energy development for the province by 2020, the two following scenarios were set out:

- a “trend” scenario;
- a “20-20-20” scenario.

The “trend” scenario was directly set out extrapolating the 2020 variation trends of production and consumption inferred from the data referring to 2000 – 2007 available in the database and it was assumed presuming that the variations keep going linearly without referring to the variables (population, industrial activities, cars, ...) that cause the estimated variations. Clearly, this scenario is an extreme hypothesis, useful only as a reference, since the situation in the next 12 years may not mirror what happened in more recent years. The current volatility of oil price and the subsequent difficulties of foretelling its evolution even in one or two years time or the drastic reduction in the automotive market demonstrate how difficult it is to think that the current evolution keeps going unchanged in the future.

The “20-20-20” scenario matches the development of the energy sector with great attention to environmental aspects. The hypothesis is to achieve, in 2020, the so-called 20-20-20 objective proposed by the European Commission:

- a 20% reduction (compared to the 2005 levels) of energy consumption through the development of energy efficiency;

- a 20% reduction (compared to the 2005 levels) of CO₂ emissions;
- the production of 20% of the total required energy through the exploitation of renewable energy sources (FER).

However, such scenario presents clear critical points:

- C. the objectives set by the European Union should represent the joint result of the actions of the whole Union and of all sectors, whereas the sharing among smaller territorial bodies is not defined (this issue is known as “burden sharing”). Thus, holding that the province shall reduce its consumption and its CO₂ emissions by 20% is totally arbitrary (the reduction commitments undertaken by Italy are, as you know, lower) and it only represents a reference prospect, characterised by utmost attention to the environmental issues;
- D. however, if consumption and/or emission reduction objectives were precisely set, they could be achieved with a totally different combination of actions and technologies. Clearly, a reasonable way to define the best combinations should refer to the minimization of the costs (as regards production as well as external costs) relevant to the various actions. However, as stated above, the current period of uncertainty does not allow sufficiently reliable forecasts on the interesting horizon of this plan and the prospects are strictly linked to the development of technologies that should take place in the next few years;
- E. the CO₂ emissions of the province are of two types: direct emissions, estimated according to the regional inventory of emissions, and those associated with the production of electric power of the National Grid, from which the province draws most of its consumption. While there are accepted estimates of CO₂/MWh emissions regarding the past years, it is not easy to estimate what may happen in the future. The more the national power mix will opt for renewable energy, the more also the emission burden of the province will decrease. Thus, the assessment herein carried out depends, in non negligible extent, on the hypotheses introduced regarding the evolution of the emissions of the national grid. In any case, a scenario such as the “20-20-20” represents the result of a combination of targeted actions, very attentive and demanding, that require a strong effort by all players involved, from government bodies to private citizens.

The following figures show the trends of CO₂, of consumption and of renewable energy sources (FER) through the application of the scenarios:

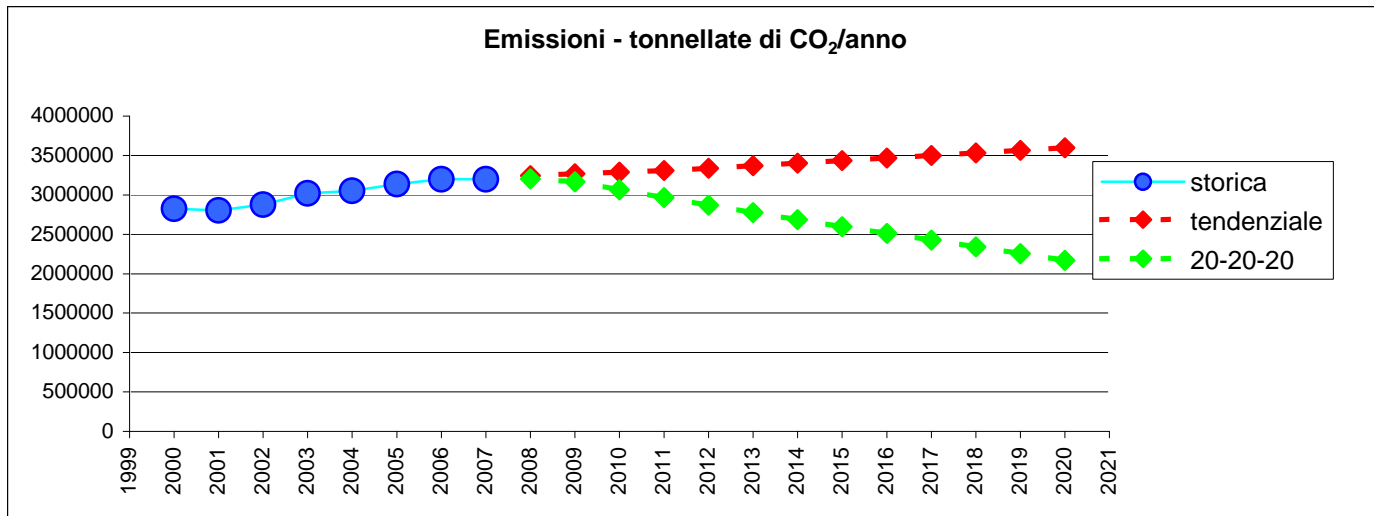

Legenda: emissions – tons of CO₂/year
Historical – trend

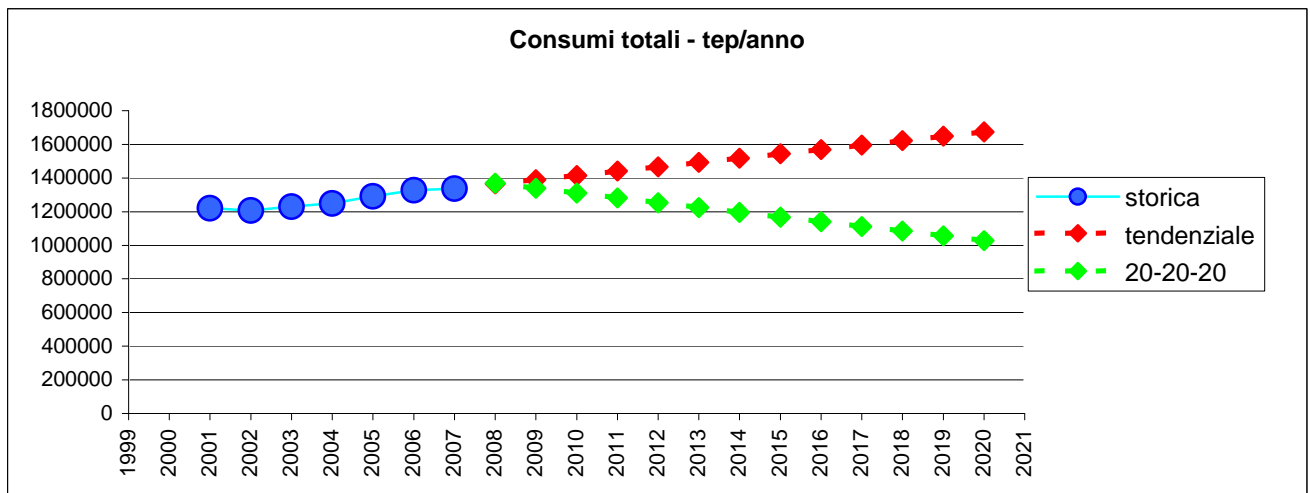

Legenda: overall consumption – tep/year
Historical – trend

In 2008 and 2009, the Milan Polytechnic could not carry out an extensive dialogue with the stakeholders and identified, as an example, a “third” possible scenario which places in-between the previous two. Other scenarios may be proposed and assessed with a simplified spreadsheet (see previous chapter) and, in case, adopted as reference by the Administration.

The scenario herein proposed is based on the results achieved by the Kyoto Lombardia Project implemented by the Fondazione Lombardia per l’Ambiente (Lombardia Foundation for the Environment) and Regione Lombardia (AA.VV., 2008) and recently wound up with the publication of a volume that summarizes the researches that have been carried out. In particular, within this project, an overall model of energy demand and production of Regione Lombardia from today to 2020 and the relevant consequences on CO₂ emissions have been defined, through a complex economic model called MARKAL-TIMES, originally developed by the International Energy Agency (IEA) and used in several applications all over the world (please refer to: www.etsap.org/Tools/MARKAL.htm or Godlstein and Tosato, 2008), that was adjusted in order to be used at regional level.

Of course, the situation of the region is rather different from that of the province of Cremona, also due to the fact that a remarkable part of the electric power used is produced in Lombardia and thus the import quota of electric power is much lower than that of the province. However, since the model used is linear every year, rather than the values of each component of the problem, the mutual relations count and this is the way the result of one of the examined scenarios, summarized in the following table 3.7, should be seen. It indicates the reductions of CO₂ emissions (at the minimum cost) that each sector should carry out in order to achieve the 2020 objective:

SECTOR	REDUCTION [%]
Agriculture	-20
Power generation	-25
Industry	-22
Residential	-14
Tertiary	-7
Transport	-21

The emissions estimated for the scenario under consideration are shown in the following figure:

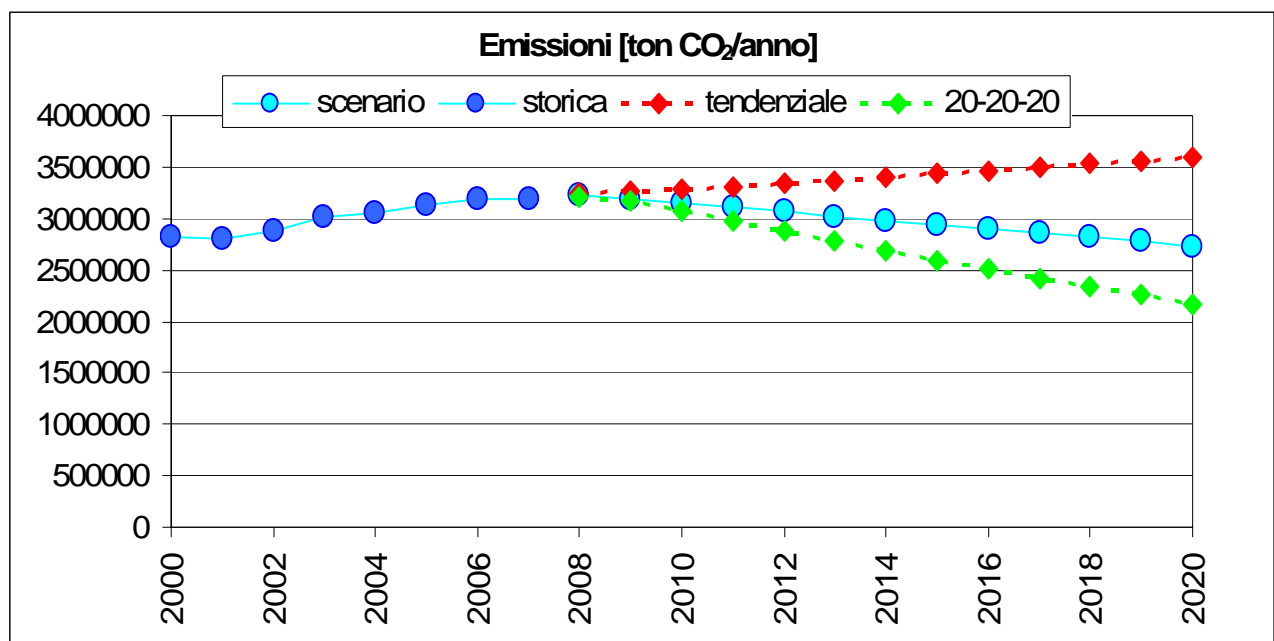

Legenda: emissions – tons of CO₂/year
Historical – trend

As shown, the scenario would meet the objectives of emission reduction and of renewable source amount on the overall demand. The only objective that would not be achieved, in the supposed scenario, would be the 20% reduction of consumption, tricky objective for the province that has witnessed a recent remarkable growth and that, however, has lower consumption per resident compared to other provinces in Lombardia.

2.1.3 New Administrative Methodology

In this section Cremona describes new methodology useful to cut the time required to get the water concession and the energy permit.

This new tool is just applied from Cremona in the current applications and uses many times the Conference of the bodies.

This methodology is voluntary and the private subject asks every time to Province of Cremona to apply it.

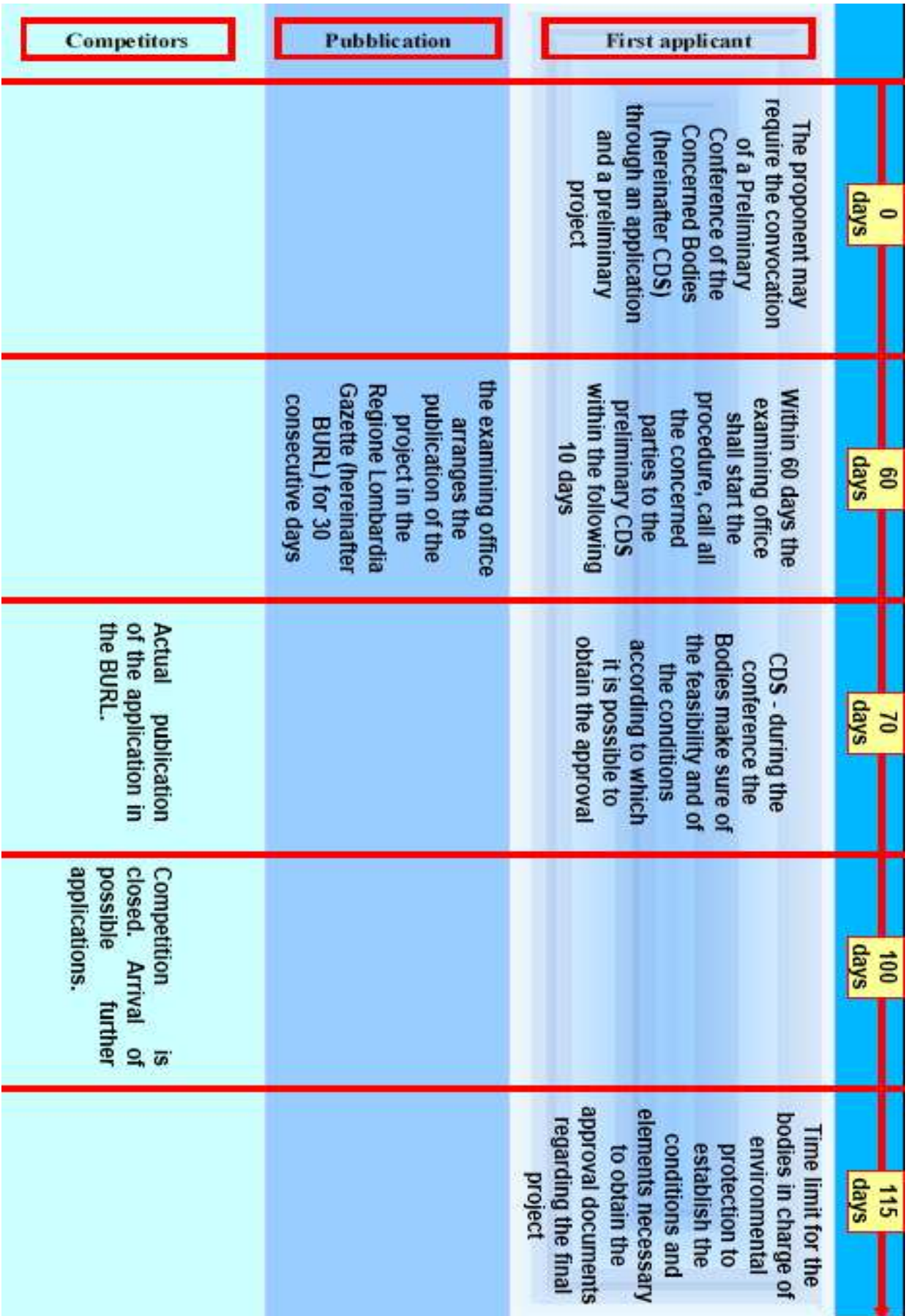

Competitors	Publication	First applicant	
<p>Within such term possible competing applications shall be assessed and chosen thus starting the procedure</p>		<p>Last meeting of the preliminary CDS is called. The final CDS decree shall define the term by which the final project shall be submitted (max 300 days from the application reception) + delivery of the EIA screening decree</p>	<p>125 days</p>
	<p>Time is over as regards the submission of private or public remarks for first instance</p>		<p>130 days</p>
<p>Publication of possible further competing applications</p>			<p>135 days</p>
	<p>Time is definitely over as regards competing applications started at the 100th day</p>		<p>160 days</p>
<p>Time is definitely over as regards the submission of competing remarks</p>			<p>195 days</p>

Procedure description:

days.	Administrative steps	publication	competitors
0 days.	The proponent may require the convocation of a preliminary Conference of the Concerned Bodies (hereinafter CDS) through an application and a preliminary project containing the basic information required by art. 11 of the R.R. no. 2/2006, the receipts of payment of examination and publication costs (art. 14_b - 241/1990), the basic information for art. 12 of 387/2003 (road practicability for works, electrical works and power line, environmental mitigation works, sanitation and occupied working premises (ASL), town planning compliance (zoning), noise pollution, aspects linked to the property (cadastral parcel map, beneficial uses, etc.).		
60 days.	Within 60 days, the examining office shall start the procedure that will be sent to all the concerned parties along with a copy of the preliminary project, and calls the preliminary CDS within the following 10 days (art. 9 of the R.R: no. 2/2006). If the application does not include the fundamental contents, it is turned down under art. 9 of the R.R. no. 2/2006. In case of EIA, also the relevant EIA Bodies and authority will be summoned.	At the same time, the provincial office arranges the publication of the project in the Regione Lombardia Gazette (hereinafter BURL) for 30 consecutive days for the Competitors and in the Municipal Notice Board for 60 consecutive and natural days from the publication in the BURL. If the application is subject to EIA procedure, the publication is also valid for the EIA	
70 days.	CDS: during the conference, the Bodies make sure of the feasibility and of the conditions according to which it is possible to obtain the approval and lay down the contents for the final projects regarding the concession, the authorization to build the power plant and the power line, and, if necessary, they require the submission of the EIA screening decree along with the project.		Actual publication of the application in the BURL. At the end of the 60 days, in case of competitors, the applications submitted during the competition validity period are published, the proponents are required to submit the same documents of the preliminary CDS and the EIA screening decree
100 days.			Competition is closed. Arrival of possible further applications
115 days.	If no elements blocking the carrying out of the project emerge, the bodies in charge of environmental protection, ..., shall establish, within 45 days, the conditions and elements necessary to obtain the approval documents regarding the final project.		

125 days.	Within 10 days from the delivery of the over-mentioned opinions, the last meeting of the preliminary CDS is called. The final CDS decree shall define the term by which the final project shall be submitted (max 300 days from the application reception) + delivery of the EIA screening decree		Within such term possible competing applications shall be assessed and chosen thus starting the procedure, publishing them in the BURL and requiring document integrations necessary for the final decision of the preliminary CDS. Time to submit the documents within the 300 th day shall be granted.
130 days.		Time is over as regards the submission of remarks in the first instance	
135 days.			Publication of possible further competing applications
160 days.		Time is definitely over as regards competing applications started at the 100 th day.	
195 days.			Time is definitely over as regards the submission of competing remarks
300 days.	Submission of the final project to the Province + EIA screening decree	From now on the time of the possible further competing applications follows the same path	Submission of the final competing project to the Province + EIA screening decree
330 days.	Transmission of the final project and calling of the final CDS within 60 days in case of no competing applications. Otherwise, calling of a CDS in order to collect opinions propaedeutic to choosing the best project within 30 days.		Transmission of the final competing project and calling of the CDs within 30 days in order to collect the opinions propaedeutic to choosing the best project
360 days.	ONLY IN CASE OF COMPETING APPLICATIONS: convocation of a CDS in order to collect the opinions under art. 12 of the R.R. no. 2/2006 relating to water diversion concession propaedeutic to choosing the best project and under art. 24 of the R.R. no. 2/2006 as regards the EIA. The time regarding various possible integrations that may postpone the CDS term under Legislative Decree no. 387/2003 shall be assessed.		
380 days.	ONLY IN CASE OF COMPETING APPLICATIONS: technical and examining report regarding the choice of the project with the involvement of a advisory body		
380 days.	ONLY IN CASE OF COMPETING APPLICATIONS: convocation of a final CDS on the previously chosen project under 387/2003 and power line		
390 days.	In case of no competing applications, first meeting of the UNIFIED CDS under art. 14 b par. 5 law 241/90 and under art. 12 of the Legislative Decree 387/2003 (within 180 days from the submission of the final project) and in case called for the EIA procedure under art. 24 of the R.R. no. 2/2006. The CDS will have several items on the agenda, for every item/topic an opinion shall be released only by the relevant bodies having competence on that topic. For example: as regards the hydraulic compatibility examination of the competing projects with indication of only one winner, only those concerned by the R.R. no. 2/2006 give their opinion. Final decision with indication of the winning competitor and the instructions to include in the concession rules and regulations and instructions to build the power plant and the connected works. IN CASE OF COMPETITION the CDS shall be called only as regards 387/2003 as the winner has already been chosen in advance.		



	The issue of the possible EIA decree follows, then the diversion concession grant and the rejection of competitors
480 days.	Issue of the Decree to private parties under art. 12 of the Legislative Decree 387/2003 only against submission of the registration of the rules and regulations

SMART
Strategies to Promote Small Scale
Hydro Electricity Production In Europe

WP 3 – Deliverable D3.1
Policies, methodologies & tools that may support decision makers in
implementing Small Scale Hydro Electricity Plants

**Description of the policies, methodologies, best
practices & tools that may support decision makers
in implementing
Small Scale Hydro Electricity Plants**

Chapter 2.2 Regional Secretariat of Attica





**Policies, Methodologies & Tools to
Improve the Exploitation of SHP**
2.2 Regional secretariat of Attica, Greece

Table of contents

Summary	3
2.2.1 Best tools for a good planning of the territory	4
2.2.2 The Regional/Local Energy Plan	5
2.2.3 The Regional/ Local Development Strategy	6
2.2.4 Public/Private Interests	11
2.2.5 References	13



Summary

Chapter 2.2 is the Greek contribution to deliverable D3.1 of the European Project named SMART and is written by the regional secretariat of Attica. The present report is principally oriented to the Public Municipalities and to the investors.

2.2.1 Best tools for a good planning of the territory

In Greece in general, and in Attica in particular, the co-operation scheme Region–Prefecture(s)-Local Municipalities, in conjunction with the participation of interested private investors, has removed many barriers that make the development of RES projects a long and difficult process, such as land access and acquisition, licensing procedures, financing, local reactions, etc. RES development at the regional and local level in Attica is considered important for stimulating the regional / local economy, bringing in relevant quality jobs, and providing long-term clean and reliable energy production. In Greece, the regional and local authorities play an important role in the overall licensing process for renewable energy projects.

Moreover, the regional / local authorisation) tends to be the most time consuming in the entire RES licensing chain. The environmentally friendly character of renewables as well as the benefits that well-planned RES projects can bring to a region (increased employment, economy boost, environmental upgrading, coverage of local energy needs, etc.), requires RES licensing procedures to consult the local level authorities (municipal decision) and to obtain the approval of the Regional Secretariat. The efforts focus on the following basic directions: It follows an integrated approach in local impacts assessment and enforces strict timetables and deadlines, within which each opinion-giving entity should provide its opinion to the regional authority.

However, the large number and the varying size of potential RES projects has pointed to the conclusion that various alternatives have to be taken into account in order to set up a commercially viable, overall development process.

At the moment, optimizing the renewable scenario and moving into a reasonable commercial development and realisation, the following planning approach has been considered:

- 1) Grouping of the different characteristics, development requirements and needs for project support in accordance with the following criteria:
 - i) projects with no development effort undertaken so far
 - ii) projects at an early development stage
 - iii) projects at an advanced development stage.

These projects are further distributed into two key groups, that is, that is, one including category i) and the other including categories ii) and iii).

- 2) Planning and developing a project scheme that can be realised effectively and efficiently:
 - partly by private actors (active development 1);
 - a special component of the project portfolio (called Pilot Portfolio), possessing a strong demonstrative / multiplicative effect character, that will lead to full development (active development 2);
 - limited actions to support measures (passive development).

The Region of Attica has a Strategic Development which addresses RES development and defines the budget allocated to RES projects for the financial period 2007-2013. It relates to the management of Communal Structural Funds for sustainable development (ESPA). It

should be noted that during the first stages of commercial RES development, the RSA supported financially the investors' role during the planning and licensing select pilot RES projects. By utilising CSF and national funds (coupled, possibly, with nationally available public subsidies for RES investments). Obviously the RSA could become a catalyst for the RES development process in its territory, choosing for this purpose 2 or 3 commercial-scale RES projects, such as, a) a small wind park to be installed in an environmentally sensitive area, b) a biomass-to energy plant utilising local agricultural (and/or forestry) residues and requiring the establishment and operation of a local collection-transportation-storage infrastructure, possibly through the key involvement of local farmers' associations, agricultural cooperatives, etc, c) a region-wide programme for the installation of PV-solar roofs in public buildings, such as schools, libraries, town halls, etc and d) a hybrid SHP plan in Asopos and Oinoi. The crucial point in the realisation of any pilot projects is to demonstrate effectively how important local concerns (environmental issues, land uses, agricultural activities, local employment, etc.) can be fully integrated into the planning and execution of a RES project, in a way that not only ensures its commercial viability and profitability, but also creates positive public attitudes and gathers strong local support for the given project.

2.2.2 The Regional/Local Energy Plan

A number of common practical steps and actions have been formulated in order to promote RES development at the regional/local level. The Region has initiated some key local planning studies that are necessary to further promotion and commercial exploitation of existing significant RES resources. These include:

- (a) land planning studies, particularly in areas of high RES potential and RES installations can be installed with minimal environmental impact and minimal disturbance to other existing or already planned land uses (e.g. tourism, agriculture, forestry, etc.);
- (b) integrated environmental and water use studies, at a sub-basin (regional) level, aimed at determining an optimal, sustainable mix of possible uses of local water resources, properly selected and co-ordinated among several options: irrigation, drinking water supply, energy production (small hydro), recreational activities, etc.

Attica has supported the RES development process in its territory by informing local authorities and the general public about the multiple potential benefits stemming from the commercial exploitation of the region's renewable energy resources (wind, solar, small hydro, biomass, etc.). It has paid less attention to hydropower due to the scarcity of water resources and the fact that the relevant legislation for hybrid hydropower plants was ratified by the Greek parliament in June 2009.

Therefore, there is a priority need for RSA to formulate and carry out a concrete, integrated public RES awareness plan and a campaign, employing, a variety of means and outlets, such as: leaflets & brochures, RES documentation files, workshops, seminars & regional fora, press releases, regional & local TV, radio stations, RES information desks, small expositions, internet, etc that will focus in northern Attica where there is potential for small hydropower production.

It should be noted that public RES awareness campaign for the local authorities of northern Attica in the spring of 2010 under the rubric of SMART. The region of Attica will provide the relevant RES material (leaflets, brochures, CDs etc.) that will be produced with the project

funds. Part of this campaign's budget, besides the small budget of SMART will be covered through sponsorships and/or donations, by interested business and other entities (investors, business associations, national organisations, universities, public energy enterprises, etc.).

During this regional RES awareness campaign, specific actions will be undertaken in order to inform and activate the business community (investors, banks, professional associations, etc.) and, thus, to create a positive business climate that will foster substantial RES investment in its territory. In this way, the region is expecting to establish and regularly organise business fora, where representatives of the regional authorities and of the business community will meet, to discuss in detail all important aspects and issues concerning commercial RES development in the region. In this frame, the local stakeholders' meeting will provide information about the SHP development prospects in Asopos.

2.2.3 The Regional/ Local Development Strategy

Let us provide a short introduction the Regional/Local RES Development Strategy has been based. The very basic documents that have been taken into consideration by the RSA have been (a) the White Paper (1999) on RES), which sets the target of doubling the share of renewable energy from 6% to 12% of the gross inland energy consumption within the EU by 2010, and (b) the Green Paper on the Security of Energy Supply (2000), and the EC Directive 2001/77 which supported a Community framework for RES generated electricity ("RES-E"). Both documents have foreseen a doubling of the share of renewables in total energy consumption by the year 2010. In addition, the European Renewable Energy Council, issued a strategic report entitled: «Renewable Energy Scenario to 2040», which outlines how 50% of the global energy supply can come from renewable energies by 2040.

Moreover, the EU Directive 2001/77/EC on electricity from RES sets an indicative target for Greece, that is, a 20.1% cover of its total electricity demand from renewables (including large hydro), by the year 2010. This target corresponds to about 2,800-3,000 MW of RES installations (not including large hydro plants), expected to be constructed and operated by 2010, i.e. a 5-fold increase over the country's currently installed RES capacity of about 600 MW. Moreover, the national target of 3,000 MW of RES installations operating by 2010 has been certainly ambitious.

During the first half of the 2001-2004 period, a total of 13,000 MW of applications for RES projects have been submitted to the Greek Regulatory Authority for Energy (RAE) in order to obtain the required electricity production license. After the exhaustive technical and economic evaluation of these applications, the Regulatory Authority awarded electricity generation licenses to RES projects totalling more than 4,000 MW, ~3,500 MW of which are wind parks.

The rapid RES development in Greece supports its national plan for limiting greenhouse gas emissions, which was approved by the Council of Ministers in February 2002 (Act of the Council of Ministers 5/27.02.2003) will save 4.4 million tonnes of CO₂ equivalent per year. It requires the installation of about 2,500 MW of RES, a figure which is very close to Greece's RES electricity target for 2010, under Directive 2001/77/EC. More specifically, the total installed electric capacity in Greece in 2003, amounted to 12,697 MW_e, showing an increase of about 12% in comparison to the 2000 levels. Out of this total capacity, 88% is installed on the mainland (interconnected system), while the remaining 12% is distributed on the non-Interconnected Islands (non-interconnected or autonomous system). In addition to this share for the islands, a capacity of about 50 MW was temporarily installed in order to feed local grids during the summer period of 2003

(1.6.2003 to 31.9.2003). As expected, electricity production from renewables (including large hydro plants), has been increased.

Law 2773/99 on the liberalisation of the Greek electricity market has set up important provisions regarding the energy produced from RES, such as, (i) Priority of access to the electricity grid for RES power plants with a capacity up to 50 MW_e (specifically for hydroelectric plants up to 10 MWe); (ii) Ten-year contract between each independent producer and the System Operator, for the purchase of the renewable electricity produced.

The Table below presents the installed capacity for each type of RES installation in Greece (2005).

Table2.2. 1 RES-E INSTALLED CAPACITY IN GREECE (2005)

RES INSTALLATIONS	INSTALLED CAPACITY MW)
WIND PARKS	525
SMALL HYDRO PLANTS	65
BIOMASS	20
PHOTOVOLTAICS	~1
TOTAL (MW)	611

RET	1990	1991	1992	1993	1994	1995	1996	1997	1998	1999	2000	2001	2002	2003
<i>Wind Energy</i>	0	0	1	4	3	3	3	3	6	14	39	65	56	88
<i>Hydro – 1MW</i>	1	0	0	0	1	1	1	1	1	1	2	3	5	7
<i>Hydro 1-10 MW</i>	5	6	4	7	8	8	10	12	12	14	12	8	8	15
<i>Hydro 10+ MW</i>	147	260	185	189	215	295	363	321	307	381	304	169	228	389
Hydro (total)	153	266	189	196	224	304	374	334	320	396	318	180	241	411
<i>Biomass in Households</i>	702	702	702	702	702	702	702	702	702	702	702	702	702	702
<i>Biomass in Industry, etc.</i>	191	195	196	197	191	195	206	209	205	209	243	236	246	207
Biomass (total)	893	897	899	899	894	897	908	911	907	911	945	938	948	910
<i>P/V</i>	0	0	0	0	0	0	0	0	0	0	0	0	0	0.1
Solar	56	63	70	75	79	82	86	89	93	97	99	100	102	105
<i>Biogas</i>	0	0	1	1	1	1	1	1	1	1	1	33	48	36
<i>Geothermal</i>	3	3	3	3	4	3	3	2	3	2	2	2	1	1
Total RES	1105	1230	1162	1178	1204	1290	1375	1340	1329	1420	1403	1319	1396	1550

Figure 2.2.1 PRIMARY ENERGY PRODUCTION FROM RENEWABLE ENERGY SOURCES IN GREECE (in ktoe), 1990-2003. (CRES) <http://www.cres.gr>

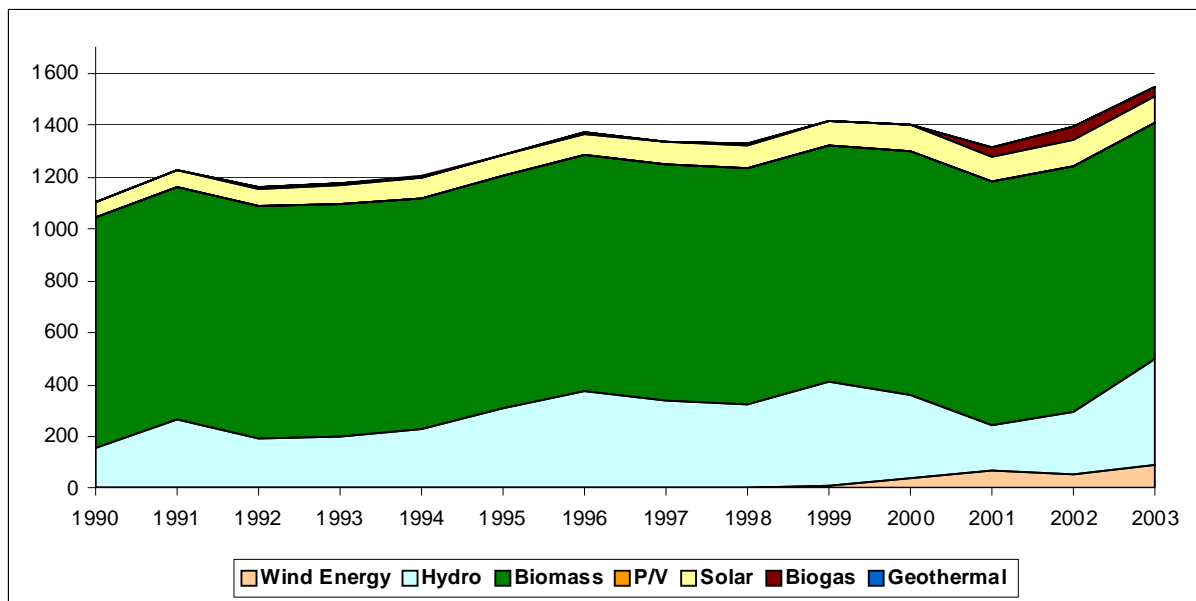

Figure 2.2.2 PRIMARY ENERGY PRODUCTION FROM RENEWABLE ENERGY SOURCES IN GREECE (in ktoe), 1990-2003_(CRES, <http://www.cres.gr>)

An estimation of the RES penetration levels by 2010 has been published by the Greek Ministry of Development, under the 2nd National report regarding the penetration level of RES in Greece by the year 2010, in accordance with the articles 3 & 6 of the EC Directive 2001/77. This report assumes that the completion of all required -and planned- works for the reinforcement of the grids is based on the economically viable RES potential as well as on the relevant investors' expressed interest.

The implementation of all RES investments with an expressed interest by 2010 (optimistic estimation) will result the quantitative target of the Directive 2001/77 for Greece.

Table 2.2.2 THE FORCASTED power production from renewables IN GREECE by 2010. (Greek Ministry for Development, «2nd National Report on articles 3 and 6 of Directive 2001/77/EC» <http://www.ypan.gr>)

RET	Installed Capacity in 2005 (MW)	Estimated Installed Capacity by 2010 (MW)	Estimated energy production by 2010 (TWh)	RES by (%)	share 2010
Wind	525	2,170	6.08	8.5	
Small-scale hydro	65	475	1.66	2.3	
Large-scale hydro	3,060	3,680	5.47	7.6	
Biomass	20	125	0.99	1.4	
Geothermal	0	8	0.06	0.1	
Photovoltaics	~1	5	0.01	0.01	
Total	3,671	6,463	14.27	19.9	

Taking into consideration the available national financial-support instruments (basically the Operational Programme "Competitiveness" (CSF III) and the National Development Law), public funds are available for about 850 MW of RES investments, out of 2,150 MW which are economically viable. In the case of a partial implementation of the RES projects' total portfolio, i.e. just the part of RES projects which have or will receive a capital subsidy (Conservative Scenario), RES penetration level will reach 14% by 2010, considerably lower than the Directive's indicative target for Greece.

Table 2.2. 3 CONSERVATIVE ESTIMATION OF POWER PRODUCTION FROM RENEWABLES BY 2010 (Greek Ministry for Development, «2nd National Report on articles 3 and 6 of Directive 2001/77/EC» <http://www.ypan.gr>)

RET	Installed Capacity in 2005(MW)	Estimated Installed Capacity by 2010 (MW)	Estimated energy production by 2010 (TWh)	RES share by 2010 (%)
Wind	525	1,200	3.36	4.7
Small-scale hydro	65	200	0.70	1.0
Large-scale hydro	3,060	3,680	5.47	7.6
Biomass	20	100	0.79	1.1
Geothermal	0	8	0.06	0.1
Photovoltaics	~1	5	0.01	0.01
Total	3,671	5,193	10.39	14.5

Consequently, a significant share of the country's RES potential is still remaining unexploited, for reasons originated from technical as well as non-technical obstacles. Further promotion and enhancement of RES development efforts at the regional and local level, beyond other obvious benefits (stimulation of regional / local economy, contribution to employment, etc.), may also significantly contribute to the national efforts aimed at reaching the indicative EC targets for Greece.

The actions taken by the Regional Secretariat of Attica have taken into consideration the regional priorities and objectives, such as, stimulating local economies, creating new jobs, protecting the environment, improving provision of electric power, stabilising the grid, and targeting economic returns on local investments. These objectives assume a realistic portfolio of projects that will be fully developed and implemented at the time horizon of, say, 2020, even if the corresponding energy potential is not always maximised.

2.2.4 Public/Private Interests

Over the years, the RSA has attracted firms interested in RES development and has secured suitable grants in order to support projects targeting long-term contracts with the system operator. Like any other region supporting RES project development, the RSA has supported the following actions:

Passive Development – use the information available (i.e. elaboration of key studies) and a subsequent dissemination activity to attract a commercial developer.

Active Development –the region / prefecture(s) / local municipalities scheme provides financial and management support to continue the initial development work (mainly through sub-contracting) that delivers the core building blocks to enable the portfolio to attract financial or strategic investors.

Develop, Build, Operate, Transfer (DBOT) – requires the scheme to undertake the entire development process, initial financing and plant commissioning such that a fully operational portfolio could then be sold to a third party.

Full Ownership – the scheme undertakes the full development process and then retains the portfolio as a revenue source.

The renewable investments are, in most cases, capital intensive, meaning that the construction costs far exceed the operating costs - which are lower than any other conventional generating source. RES plants sensitivity to financial variables such as discount rates or delays in construction and development make them hard to attract investors. An analysis of the options allows the project scheme to finance the whole project, or a certain component of it in the following way:

- Region's / Prefecture's own budget allocation (targeted specifically to RES development)
- Partners' balance sheet (identification of investors'/developers' desirable financial characteristics)
- Development cost support (additionally to the Region's/Prefecture's own budget), i.e. European Community Support Framework – CSF), National Development Funds (National Development Law), European Investment Bank
- Commercial banks, Green funds

Socio-economic prioritisation of project portfolios are based on choosing specific geographical areas for economic stimulation based on the existing RES potential, the Region may initially express a preference for specific sites, which will result in more job openings. Other factors include, the development added value (e.g. provision of reliable and efficient source of power for small independent systems and/or feeding into the national grid, etc.), the employment potential (regional and local opportunities during the different stages of the realisation of the project portfolio – Development, Construction, Operation), the local contracting opportunities (civil works, maintenance tasks, etc.).



2.2.5 References

European Commission, «White Paper for a Community Strategy and Action Plan», COM(97)599, November 1997

European Commission, «Directive 2001/77/EC on the promotion of electricity produced from Renewable Energy Sources in the internal Electricity Market», Official Journal of the European Communities L.283/33, October 27, 2001

European Renewable Energy Council (EREC), «Renewable Energy Target for Europe – 20% by 2020» (publication)

European Renewable Energy Council (EREC), «Renewable Energy Scenario to 2040», May 2004

Greek Regulatory Authority for Energy (RAE), «General Information on the Greek Electricity Sector for the period 2000-2003: Installed capacity, production & consumption levels, Renewable Energy Sources and Long Term Energy Planning», 2004

Greek Ministry for Development, «2nd National Report regarding penetration level of Renewable Energy Sources in the year 2010», October 2003

G. Skodras, P.S. Amarantos, E. Papadopoulou, E. Kakaras: «Utilisation of Landfill gas for Energy Production – Operational Experience from a 13.8 MW_e Power Plant»

European Renewable Energies Federation (EREF), «Good Planning Guide for Renewable Energy Installations», January 2004

N. Vassilakos, V. Kiliadis, J. Kambouris: «Optimal Regional Integration of Renewable Energy Sources in Southern Europe – Implementation Guidelines», September 2005 (under the auspices of the DG TREN / ALTENER PROGRAMME)

WEB SITES - EUROPEAN LINKS

European Renewable Energy Council (EREC)
<http://www.erec-renewables.org>

Organisations for the Promotion of Energy Technologies (OPET) Network
<http://www.opet-network.net>

The European Renewable Energies Federation (EREF) <http://www.eref-europe.org>

European Forum for RES (EUFORES) <http://www.eufores.org>

European Wind Energy Association (EWEA) <http://www.ewea.org>

European Small Hydropower Association (ESHA) <http://www.esha.be>



**Policies, Methodologies & Tools to
Improve the Exploitation of SHP**
2.2 Regional secretariat of Attica, Greece

References
Page 14 of 14

European Renewable Energy Centres Agency (EUREC Agency)
<http://www.eurec.be>

Eurostat <http://epp.europa.cec.eu.int>

Greek Ministry for Development <http://www.ypan.gr>

Greek Regulatory Authority for Energy (RAE) <http://www.rae.gr>

Greek Center for Renewable Energy Sources (CRES) <http://www.cres.gr>

Greek Public Power Corporation (PPC) <http://www.ppc.gr>

SMART
Strategies to Promote Small Scale
Hydro Electricity Production In Europe

WP 3 – Deliverable D3.1
Policies, methodologies & tools that may support decision makers in
implementing Small Scale Hydro Electricity Plants

**Description of the policies, methodologies, best
practices & tools that may support decision makers
in implementing
Small Scale Hydro Electricity Plants**

**Chapter 2.3 Thaya County, Austria
(Zukunftsraum Thayaland - Austria)**





Policies, Methodologies & Tools to Improve the Exploitation of SHP

2.3 Thaya County, Austria

Table of contents

Summary -----	3
2.3.1 Best tools for a good planning of the territory -----	4
2.3.1.1 The Masterplan SHP for the federal land Lower Austria 2009-----	4
2.3.1.2 The strategy for the “Energy And Climate Model Region Waldviertel”-----	5
2.3.1.3 Regional energy plans for the micro regions in Waldviertel-----	6
2.3.1.4 Local Energy Plans for municipalities-----	7
2.3.1.5 Water data register Lower Austria – important source of information-----	8
2.3.2 Implementation of private & public joint investment -to promote the interest to invest in small scale hydro electrical production -----	15
2.3.2.1 WEB AG - The regional participation model for renewable energy-----	15
2.3.2.2 The actual planning for a regional energy contracting model-----	16
2.3.2.3 Regional Energy Round Table in Waldviertel-----	17

Summary

Chapter 2.3 is the austrian contribution to deliverable D3.1 of the European Project named SMART and is written by Thaya county. The present report is principally oriented to the Public Municipalities and to the investors.

In the Zukunftsraum Thayaland (Thaya County, part of the region Waldviertel in the federal land Lower Austria) there are different examples for policies, methodologies, best practices & tools to support decision makers in implementing Small Scale Hydro Electricity Plants.

The Masterplan SHP is a strategic political tool of the government of the federal land Lower Austria. It represents a noticeable step of the government into the direction of positioning pro hydro power – but with strict consideration of national and European rules and guidelines. The strategy for the climate- and energy model region Waldviertel comprises altogether 14 micro regions. The Zukunftsraum Thayaland is one of these micro regions with its own strategy and energy plan – in coordination and collaboration with the other micro region in Waldviertel. These energy plans for the micro regions consider the potentials of the complete micro region – and describe mainly actions that need the inter-communal collaboration because of the complexity and/or the extensiveness of the challenges and finally of the measures.

The Zukunftsraum Thayaland consists of 15 municipalities – already 9 of them have their own local energy plan – a paper that describes the situation, the potentials, the action plan with concrete activities and projects in the fields of energy efficiency and renewable energy. The Water Data Register as part of the Water Date Network Lower Austria is a very helpful and uncomplicated source of information for all people interested in water issues. It is web based with free access.

Zukunftsraum Thayaland demonstrated implementations of ideas and projects – also with the character of join investments – in different fields like biomass, SHP or waste water treatment. The examples described in chapter 2.3.2 had as initiators more private persons and companies but finally the municipalities are more ore less partners in different ways – PR work, provision of public area and/or public services and last but not least also investment.

2.3.1 Best tools for a good planning of the territory

2.3.1.1 The Masterplan SHP for the federal land Lower Austria 2009

In february 2009 the federal land Lower Austria presented the “masterplan hydro power”. The amplified use of small hydroelectric power is in the main focus.

Therefore the potential that is ecologically defensible shall be estimated. Not only the extension of existing plants is in the foreground but also ecological improvements of existing power plants. The state Austria also promised support, the handling of the approval procedure shall become more efficient in the future.

The state Austria and the federal land Lower Austria have set up new sponsorships for ecological improvements of existing power plants, such as improvement of the passability (e.g. fish ladders) as well as restructuring (e.g. measurements on the riverbank). The measurements are sponsored up to 30% by the federation, the federal land Lower Austria agreed an additional sponsorship which leads to a possible total sponsorship of 55% of the investment costs. Lower Austria created a second sponsor possibility for energy efficient improvements where up to 25% of the investment costs can be sponsored; the operator receives a max. of 50.000 Euro aid money.

According to the water management plan of the federation 100 plants shall be supplied with fish ladders until 2015 which corresponds to an investment of 12 mio Euro. The federal land Lower Austria is prepared to support the installation of fish ladders for 300 small hydroelectric power plants in total. This corresponds to an investment of 36 mio Euro, the land supports with 9 mio Euro.

In the public authorities there were special teams formed to enable an efficient and quick handling of the approval procedure. The teams consist of lawyers and experts for hydraulic engineering and nature protection.

OUTCOMES:

The result is a clear increased interest of actual and potential operators for improvements, modernizing, reconstruction and also new construction of small hydroelectric power plants.

At the moment about 300 small hydroelectric power plants exist in Lower Austria, with 50 kw each, that generate 420 giga watt hours per year. This corresponds to 4,2 % of the power requirement of Lower Austria resp. a supply of app. 120.000 households.

By the improvement of existing plants by p.ex. the installation of modern turbines resp. small increase of the retention water level elevation app. 65 giga watt hours could be generated additionally and therewith the supply of another 18.000 households.

By means of new power plants up to 750 giga watt hours could be generated per year from the pure energy efficient view. If ecological criteria are also considered, the development potential is 50 giga watt hours which can be increased up to 300 giga watt hours if further water lines were taken into consideration with accompanying ecologic measures.

2.3.1.2 The strategy for the “Energy And Climate Model Region Waldviertel”

Since more than 20 years the Waldviertel is characterised by an active engagement for environment-, climate- and energy policy, supported by the population. The Waldviertel stands for successful models such as the regional development agency, agency for village and urban renewal, the environmental consulting, the financing by public participation in renewable energy projects (“WEB -AG“, ”BEB-AG“, ”Solarstrom Waldviertler Schuhwerkstatt“) or the “Energieagentur der Regionen”-active all over Lower Austria, of which the products and projects for urban energy policy and energy efficiency are awarded i.a. with the Energy Globe, the prize for climate protection, the EURGIO innovation prize or the Energy Profi.

Because of the enormous dense of actors and model projects the region heads for an energy autarky until 2030 whereas the 20/20/20-target must be clearly exceeded. The chosen strategy can very well be reproduced as it does not build on cutting-edge research and is therefore not dependent on it. The policy builds on the great potential that consists of the effective transfer of proven and explored solutions to potential users and of the networking of actors.

The region suits the model region well due to the immense motivation and identification of its actors as well as due to the dimension and closeness. There is no other region in Austria that has a similar high density of existing communal climate-simulation-scenarios. With reference to the regional structures (regional management with taskforce energy and climate, leader-groups, energy manager in the app. 12 micro regions, energy regulars’ tables) a stable structure shall emerge to attain the energy autarky. This structure shall contain regional pools of resources and commercial cooperation models. Participation models for the financing shall be launched. A broad approach was chosen: it contains energy saving as well as renewable energy (focus on sun, wind, water, biomass), the sector traffic and also the “gray energy”. The possibility to control achieved improvements is a necessary part of each regional climate strategy.

A base knowledge of the region, the actors and decision makers is necessary to be able to elaborate and establish such an entire strategy for a region including detailed strategies for the micro regions. From the point of view of the water power it is important to know the actual situation of the region – sites, types, age, power, operator, problems, potentials for improvement of preferably many of the existing resp. potential power plants.

OUTCOMES:

The system of the strategy for the Waldviertel to the energy autarky until 2030 is as follows:

- Strategy for the complete region Waldviertel – essential targets, structures for cooperation and communication, networking between the micro regions and other regional institutions, coordination of the activities and evaluation of the total results.
- Strategies and action plans for the micro regions (each with between 7.000 and 27.000 inhabitants – each with 5 to 15 municipalities) – precise targets and timetable for each micro region regarding the topics energy saving and renewable energy. Small hydroelectricity is one of the topics.

Annual targets for all categories and micro regions of the Waldviertel in cooperation with the decision makers shall be defined in the project, the target achievement shall be announced. This enables early warning for the identification of problematic zones with an increased need for action and useful informations of the micro regions and branches, out of which successful strategies for the further realisation can be developed.

Finally there is a conclusion about the usage of the developed methods and tools for the realistic achievement of the energy self sufficiency target by 2030 and for the sustainable establishment as model region.

2.3.1.3 Regional energy plans for the micro regions in Waldviertel

The Waldviertel consists of 14 micro regions with a partly very different structure – economically, socially, scenically, climatically. The micro region Thayaland is one of the 14. In the next months the Austrian climate- and energy funds will provide big subsidies for model regions in Austria. It is the strategic target in the Waldviertel that preferably many of the 14 micro regions receive the status model region. Each micro region that achieves this status can get subsidies for the following:

- energy concept for the micro region
- personnel costs for a regional energy manager for 2 years
- measures for sensitisation and networking

Work content for the energy concept:

- Wording of energy strategic strength and weakness of the region – regarding availability of natural resources, human resources, infrastructure, traffic, economic structure and the like
- Is-analysis of the energy supply and the energy consumption situation
- Identification of the potentials for energy saving and renewable energy
- Wording of energy political targets until 2020 with triennial sub-ordinate targets
- Development of strategies to reduce weaknesses and to achieve targets
- Mentioning of realisable projects that lead to a reduction of greenhouse gas in the region
- Strategy for a continuation of the development work of the model region after the expiration of the support by the climate- and energy funds.
- The concept is made with the participative involvement of the actors of the region and uses the expert support with the scientific methods. Therefore this kind of participative involvement of the main actors (economy, politics, population, unions, etc.) shall be illustrated.

Work content for the energy manager:

In the course of the concept of the model region know-how shall be built on site to safeguard the realisation, to achieve a best possible penetration and to fix received experiences permanently. This target, p.ex., shall be achieved by means of the following measures:

Workshops for the initiation of the realisation concept with a participative involvement of the relevant actors of the region

Workshops for the planning and evaluation with the relevant actors at least twice a year to achieve the targets in the realisation concept.

Formation and communication of an information central office with a clearly selected contact person, fix opening hours, telephone number and email address

Acquisition, coordination and project company of the climate- and energy projects, identified in the realisation concept.

Work content for sensitisation and networking:

Furthermore the climate- and energy funds supports accompanying measures like

- Regular (at least twice a year) networking workshops of potential actors to relevant topics
- Moderation of the development process
- Informative meetings at least 3 times a year relating to the main focus of the climate- and energy model region.
- Preparation and distribution of information material

The networking between these energy managers and the regional institutions of the Waldviertel - regional management, regional energy agency etc. will be very dense. Additionally the climate- and energy fund offers support regarding networking and information activities (p.ex. organisation of speakers for meetings, networking activities between the model regions themselves).

For energy concept a very detailed data pool of the micro region is necessary – energy sources (solar radiation, wind force, waterways, biomass resources, geothermal energy potentials), energy supply, energy demand, buildings and constructions, economic structure, decision structures, household data, ...

OUTCOMES:

- The energy concept shall represent the strategy of the micro region and at the same time be the guide for the realisation of the different activities
- The energy manager shall be the regional platform for information, motivation, networking, development of ideas and similar
- For the topic small hydroelectricity the sensitisation and networking work shall be a common platform for the regional actors for the exchange and initiation of cooperations amongst themselves and with other helpful partners

2.3.1.4 Local Energy Plans for municipalities

In the federal land Lower Austria municipalities receive a 50% subsidy from the land government for the preparation of a communal energy concept. In the Waldviertel about 30 municipalities have already used this possibility and the Energieagentur der Regionen has prepared such an energy concept for them. The funding authority supplies a list with working packages, that must be included:

- energetic analysis of the households
- energetic analysis of the buildings in the municipality
- energy monitoring for the buildings of the municipality
- energetic analysis of the enterprises
- potential analysis
- exchange of experiences
- catalogue of measures
- public relations
- communication of the results
- summary and report

The situation of renewable energy in the municipality is especially treated in the packages “potential analysis” and “catalogue of measures”.

In the potential analysis the possible usable energy resources out of sun, wind, water, biomass and geothermal energy are regarded. In the catalogue of measures possible ways of realisation and the appropriate actions, that are necessary for the use of the resources, are described.

Due to the location next to rivers small hydroelectricity is only in parts of the municipalities a relevant topic. Here are then the following working steps:

- survey of the existing plants and their power – apart and in total
- survey of the operating condition of the plants – in operation or inoperative, mains or isolated operation
- survey of the concerns and plans of the operators of the plants
- estimation of the development potential of small hydroelectricity in the municipality – here the technical potential in theory and the practical realisation potential were taken into consideration

It is up to the decision makers in policy and administration whether such energy concepts for municipalities are sponsored or ordered. If this is the case the energy concepts are very useful tools for the realisation of local energy strategies – sometimes also for the detection of such a strategy. Such concepts can provide the basic principles for small hydroelectric power plants as well as for biogas or solar electricity plants, so that interested operators take then care and bring it to realisation.

Concrete arguments about the foreseeable use in the domain “energy saving” and “renewable energy” and also a best possible atmosphere for conversation with the decision makers is necessary to convince them and the funding authority as well as the responsible persons in the municipalities about the necessity of such concepts.

OUTCOMES:

All in all the municipalities and the funding authority receive a detailed report about all working packages described above.

The report contains the following informations to the package small hydroelectricity concretely:

- description of the actual situation
- description of general conditions
- description of challenges on site
- description of local potentials
- if possible – networking with partners interested in the project realisation

2.3.1.5 Water data register Lower Austria – important source of information

The water register is – similar to the cadastre – a public book, where everybody can look at. It can be read online.

In the water register the following data must be registered:

- Mainly all existing water(using) rights of the county
- Waste sites
- An overview of water associations and water boards
- Certain orders of the water right authorities, such as e.g. water protection and sanctuary
- The borders of the (30 years) flood water flow area



The water register online is part of the "[Water data network Lower Austria](#)". On the webpage of the water data network you can find informations of how to generate an excerpt of the water register.

The data network is divided into separate modules due to professional factors. The following 9 modules that cover the whole field of action of the organisations that have interests in this data network, arise due to the separation into special fields:

- Wasserrecht (WR) - water right
- Wasserversorgung (WV) - water supply
- Abwasserentsorgung (AW) - waste water disposal
- Gewässer/Wasserbau (WB) - hydraulic engineering
- Messstellen/Hydrogeologie (MS) - measuring points / hydrogeology
- Verdachtsflächen/Deponien (VF) - potential contaminated areas
- Umwelthygiene/Trinkwasser (TW) - environmental hygiene
- Förderung Siedlungswasserwirtschaft (SW) - sanitary environmental engineering
- Einstieg/Administration (EA) - entrance / administration

Postcode of the water right with county code – The postcode of a water right is the “inventory number” of the right. With the inventory number the certificates of the plant can be found in the collection of certificates of the particular county. The counting is carried out separately for each county.

Water register excerpts:

- Extracts from the water register of particular plants can be made
- If required data beyond the water register (e.g. measuring data) can be requested by email from the federal province Lower Austria
- Also further details about the content of the water register, the duties of the water beneficiary registered in the water register, the legal effect of an entry in the water register. Furthermore about the possibilities to inspect the certificate collection and the water register only analog available resp. to get further data online
- several extracts from the water register can be recalled at the same time.

If you are interested in information about one specific water right you have to search for it. The research result contains the following informations:

- Nr – consecutively numbering of the research result
- Name of the plant – The name of the plant is important for the clear and quick identification of the plant.

+ code for the type of the plant
+ Name of the beneficiary/s of the plant
+ (optional) Trivial name or location of the plant
+ post code

+ county abbreviation (e.g. "345 SB" = post code 345 of the water register in the district Scheibbs)

- Actual beneficiary – the beneficiary/s of the water right
- Easting/Northing – the coordinates of the plant.
- Geographic integration – specification of the quality (precision) of the statement of place of the plant

- Water data network nature – all objects in the data network must be related to one nature. This gives information about the kind of the plant/the water right (e.g. water supply plant, waste site, ...)

ID – clear identification number of the plant in the database. This number is necessary if data beyond the water register excerpt is requested.

2.3.5.1 WATER REGISTER LOWER AUSTRIA -short explanation:

The link is a very long one on the website of the Lower Austrian government (http://www.noel.gv.at/Umwelt/Wasser/Wasserdatenverbund-NOe/WDV_OnlineAbfrage.html)

You have to click the following link linked with the words Wasserdatenverbund NÖ

```
Javascript:void(window.open("http://www.intermap1.noel.gv.at/website/intermap_wdv/", "", "width=1010,height=744,screenX=0,screenY=0"))
```

You will get the following map of the federal province Lower Austria

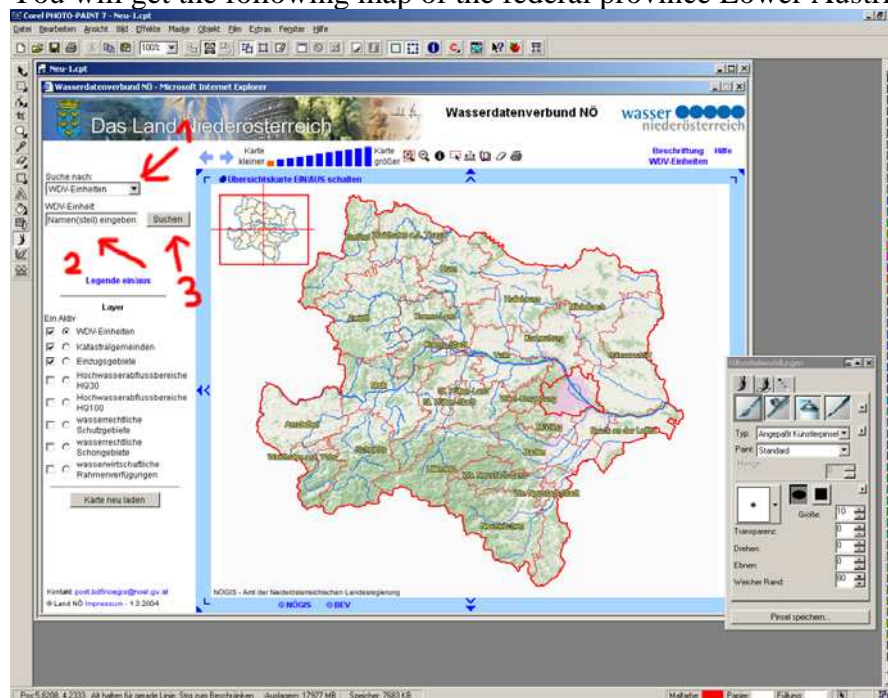

Figure 2.3.1

First you can choose "WDV-Einheiten" which means to show different water units (water uses and rights). Another possibility would be the "Einzugsgebieten" = catchment area.

1. You write in the box WDV-Einheit the name of the town/location, from where you want to know details, e.g. write the town named "Scheibbs" in it.
2. Next you have to click the button "Suchen" = search

Abfrage-/Auswahlergebnisse - Microsoft Internet Explorer

Gefundene WDV-Einheiten

In Zwischenablage kopieren Speichern

Alle auswählen Auswahl aufheben Wasserbuchauszug Hilfe

Es können maximal 30 Objekte für den Wasserbuchauszug gewählt werden.

WB	Nr.	Name	Postzahl	
<input type="checkbox"/>	1	WVA Scheibbs Stadtgemeinde (Schagerl, Einsiedler) 1255 SB	SB-001255	Stadtgemeinde Scheibbs
<input type="checkbox"/>	2	WVA AKOS Aufzüge Komponenten Scheibbs GmbH 1802 SB	SB-001802	Wittur GmbH
<input type="checkbox"/>	3	KANAL Stadtgemeinde Scheibbs 1642 SB	SB-001642	Stadtgemeinde Scheibbs
<input type="checkbox"/>	4	OME WVA Scheibbs, Schagerl-Einsiedler, 2 Quellen 1255 SB	SB-001255	Stadtgemeinde Scheibbs
<input type="checkbox"/>	5	ARA Wohnhaus Stockinger KG Scheibbsbach 2077 SB	SB-002077	Martin Stockinger, Gertraud Stockinger
<input type="checkbox"/>	6	OME Landespensionistenheim Scheibbs, Quelle 3		Bundesland Niederösterreich, Straß
<input type="checkbox"/>	7	GWME AKOS Aufzüge Komponenten Scheibbs GmbH, Brunnen 1802 SB		Wittur GmbH
<input type="checkbox"/>	8	ARA Wohnhaus Pflügl KG Neustift bei Scheibbs 2110 SB	SB-002110	Johann Pflügl, Christine Pflügl
<input checked="" type="checkbox"/>	9	WKA Stepke Günther KG Neustift bei Scheibbs 109 SB	SB-000109	Günther Stepke
<input type="checkbox"/>	10	KANAL <small>Wasserbuchauszug mit untergeordneten Anlagenteilen</small> Scheibbs 638 SB	SB-000638	Stadtgemeinde Scheibbs
<input type="checkbox"/>	11	BARA Freiwachplatz Stadtgemeinde Scheibbs 1081 SB	SB-001081	Stadtgemeinde Scheibbs
<input type="checkbox"/>	12	KANAL Schacherlsiedlung, Niederschlagswasser, Stadtgem. Scheibbs 1112 SB	SB-001112	Stadtgemeinde Scheibbs
<input type="checkbox"/>	13	OME WVA Scheibbs Luegquelle 387 SB	SB-000387	Stadtgemeinde Scheibbs
<input type="checkbox"/>	14	GWME Scheibbs, Brunnen Neubruck 387 SB	SB-000387	Stadtgemeinde Scheibbs
<input type="checkbox"/>	15	OME WVA Scheibbs Bürgerhofquelle 1 387 SB	SB-000387	Stadtgemeinde Scheibbs
<input type="checkbox"/>	16	ARA Wohnhaus Ledinek KG Neustift bei Scheibbs 2073 SB	SB-002073	Gabriele Ledinek

Figure 2.3.2

You will get the list of water units (rights) in the area of this town. WKA means Wasserkraftanlage (hydropower plant). So chose some rights (maximum 30) and click on one of the units, e.g. The number 9 WKA Stepke...

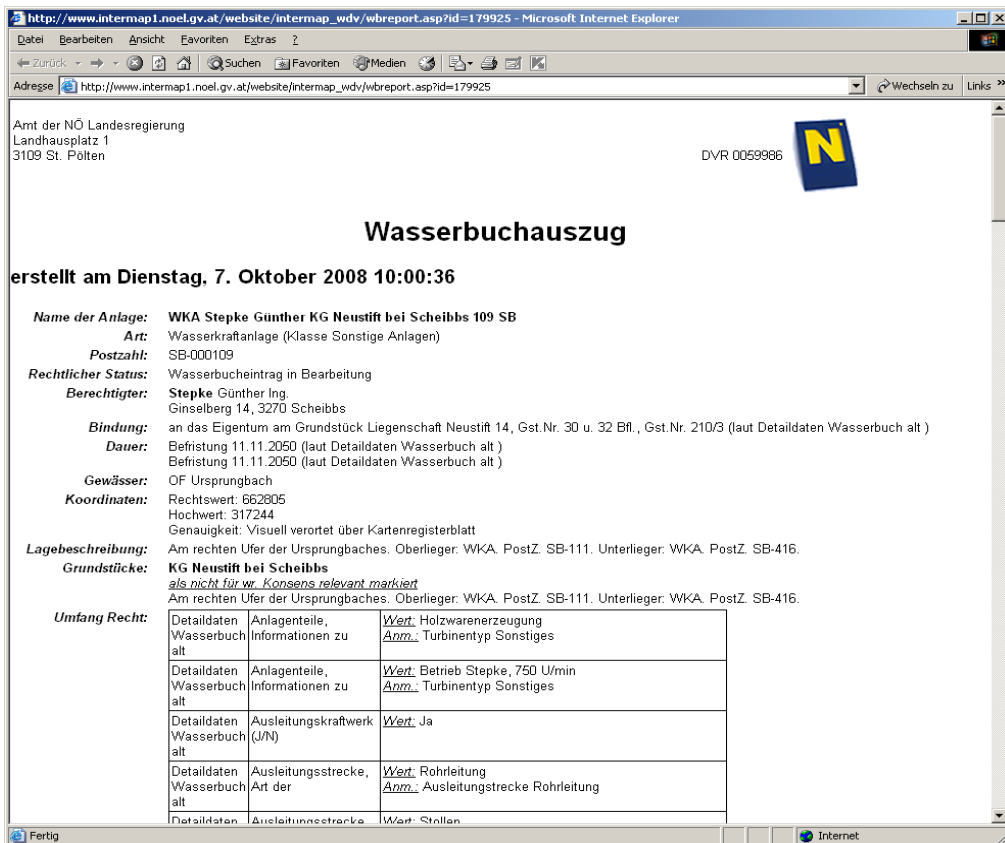

http://www.intermap1.noel.gv.at/website/intermap_wdv/wbreport.asp?id=179925 - Microsoft Internet Explorer

Amr der NÖ Landesregierung
Landhausplatz 1
3109 St. Pölten

DVR 0059986

Wasserbuchauszug

erstellt am Dienstag, 7. Oktober 2008 10:00:36

Name der Anlage: WKA Stepke Günther KG Neustift bei Scheibbs 109 SB
Art: Wasserkraftanlage (Klasse Sonstige Anlagen)
Postzahl: SB-000109
Rechtlicher Status: Wasserbucheintrag in Bearbeitung
Berechtigter: Stepke Günther Ing.
 Ginselberg 14, 3270 Scheibbs
Bindung: an das Eigentum am Grundstück Liegenschaft Neustift 14, Gst.Nr. 30 u. 32 Bfl., Gst.Nr. 210/3 (laut Detaildaten Wasserbuch alt)
Dauer: Befristung 11.11.2050 (laut Detaildaten Wasserbuch alt)
 Befristung 11.11.2050 (laut Detaildaten Wasserbuch alt)
Gewässer: OF Ursprungbach
Koordinaten: Rechtswert: 662805
 Hochwert: 317244
 Genauigkeit: Visuell verortet über Kartenregisterblatt

Lagebeschreibung: Am rechten Ufer der Ursprungbaches. Oberlieger: WKA. PostZ. SB-111. Unterlieger: WKA. PostZ. SB-416.

Grundstücke: KG Neustift bei Scheibbs
als nicht für vor. Konsens relevant markiert
 Am rechten Ufer der Ursprungbaches. Oberlieger: WKA. PostZ. SB-111. Unterlieger: WKA. PostZ. SB-416.

Umfang Recht:

Detaildaten Wasserbuch alt	Anlagenteile, Informationen zu	Wert: Holzwarenerzeugung Anm.: Turbinentyp Sonstiges
Detaildaten Wasserbuch alt	Anlagenteile, Informationen zu	Wert: Betrieb Stepke, 750 U/min Anm.: Turbinentyp Sonstiges
Detaildaten Wasserbuch alt	Ausleitungskraftwerk (J/N)	Wert: Ja
Detaildaten Wasserbuch alt	Ausleitungsstrecke, Art der	Wert: Rohrleitung Anm.: Ausleitungsstrecke Rohrleitung
Detaildaten	Ausleitungsstrecke	Wert: Stollen

Figure 2.3.3

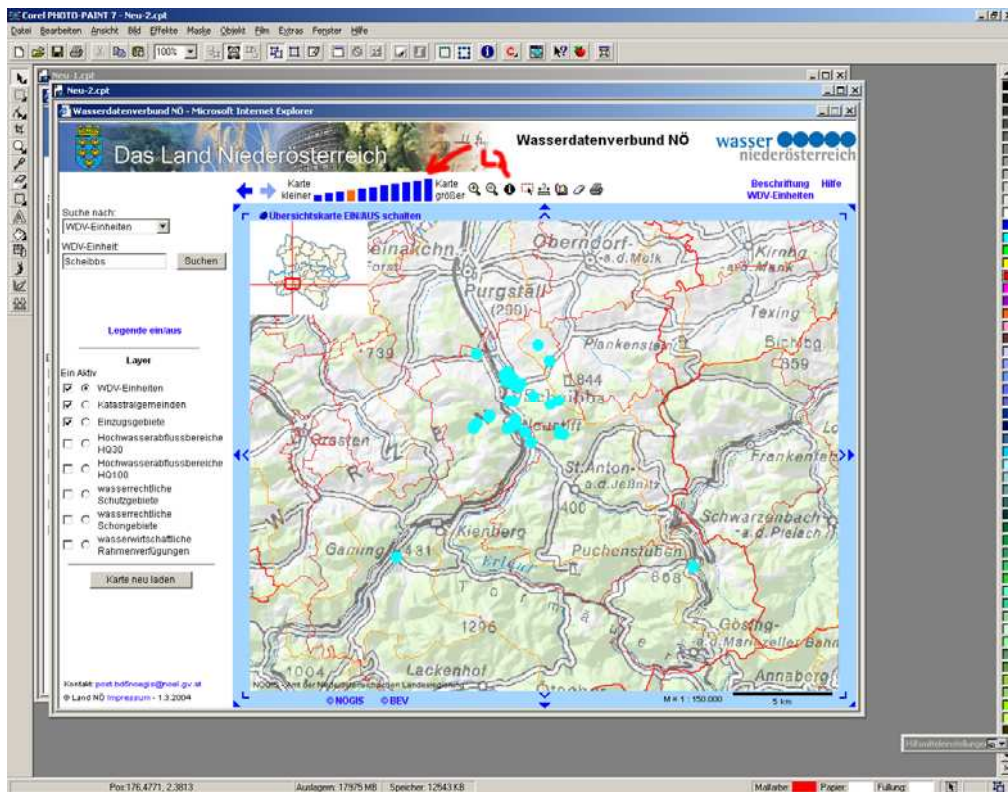

Corel PHOTO-PAINT 7 - Neu-2.cpt

Wasserdatenverbund NÖ - Microsoft Internet Explorer

Das Land Niederösterreich

Wasserdatenverbund NÖ wasser niederösterreich

Suche nach: WDV-Einheiten
 WDV-Einheit: Scheibbs

Legende einlesen

Layer

- WDV-Einheiten
- Katastralgemeinden
- Einzugsgebiete
- Hochwasserabflussbereiche HQ30
- Hochwasserabflussbereiche HQ100
- wasserrechtliche Schutzgebiete
- wasserrechtliche Schongebiete
- wasserwirtschaftliche Rahmenverfügungen

Karte neu laden

Kontakt: post.befragung@noel.gv.at
 © Land NÖ Impressum - 1.3.2004

NOEGIS © BEV

M 1:150.000

5 km

Figure 2.3.4

A new window opens with information about the SHP. If we look on the map now we see the area of the town "Scheibbs" and the places of water units.

To zoom in you can choose a larger bar on the top of the card, lets click on the largest one.

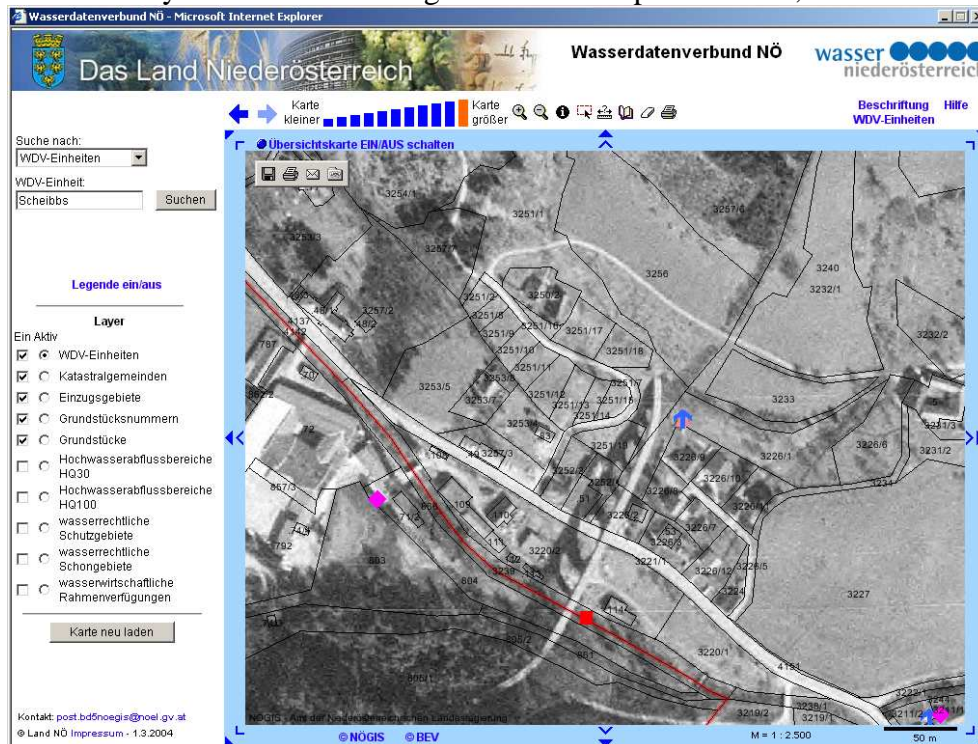

Figure 2.3.5

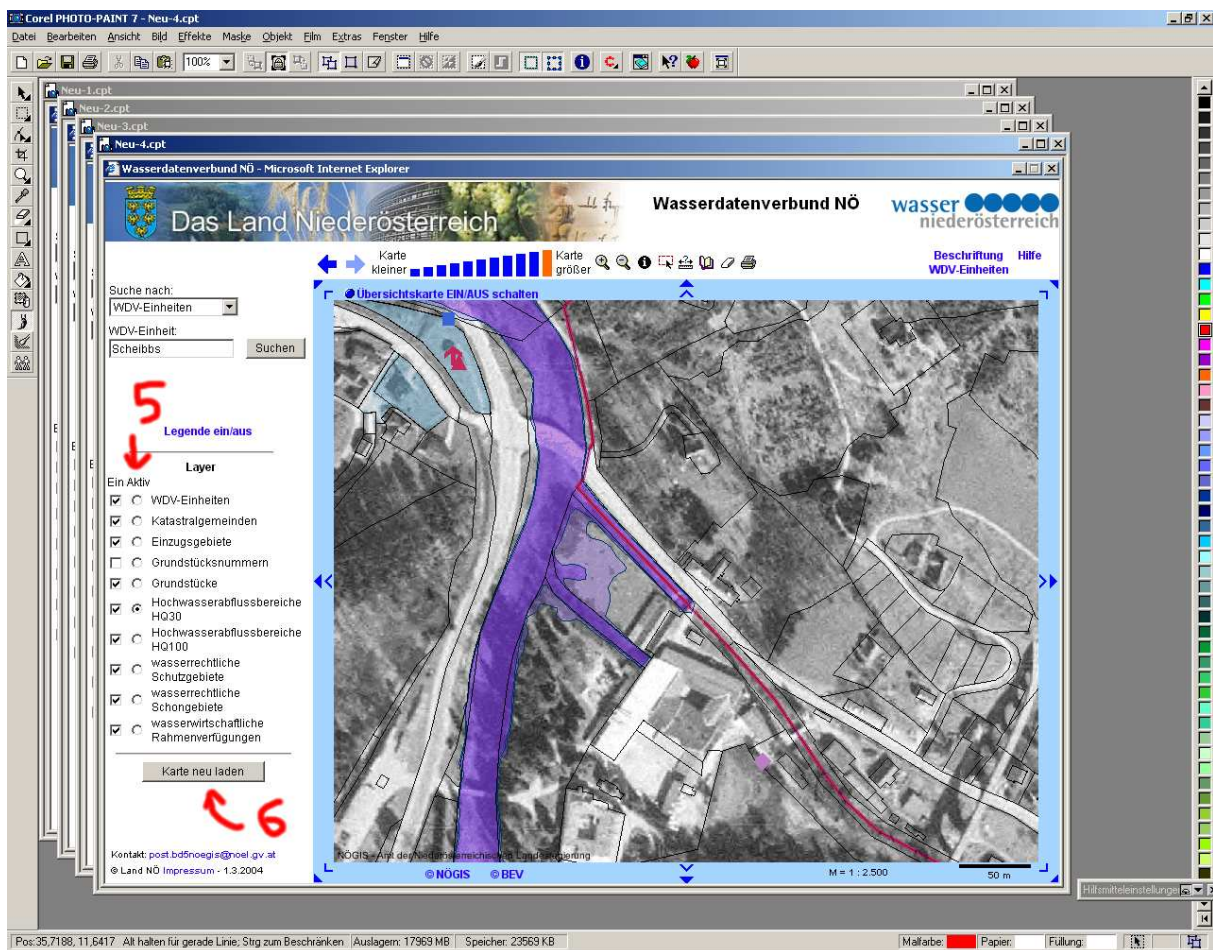

Figure 2.3.6 You can choose protection areas or flooding areas to be shown on the map.

Next you have to click the button "Karte neu laden" = reload the map.

You can navigate with the arrows on the different directions at the margin of the map to scroll around. A full arrow means a distance of a full picture, an open arrow means 1/4 of a picture to scroll in the direction.

2.3.2 Implementation of private & public joint investment -to promote the interest to invest in small scale hydro electrical production

Zukunftsraum Thayaland (part of the region Waldviertel in the federal land Lower Austria) demonstrated with a lot of successful activities that there are many creative and initiative people working in the field of energy efficiency and renewable energy.

In a positive regional atmosphere of creativity and the will for co-operation and the orientation to practical relevance there occurred already many very interesting implementations of ideas and projects – also with the character of joint investments – in different fields like biomass, SHP or waste water treatment.

The following examples had as initiators more private persons and companies but finally the municipalities are more or less partners in different ways – PR work, provision of public area and/or public services and last but not least also investment.

2.3.2.1 WEB AG - The regional participation model for renewable energy

In 1999 the „WEB GmbH” is founded as holding company for six operators of individual private windmills. The founders were three very engaged private persons from a very small village in the region Thayaland. The basic idea is the establishment of an independent regional company with the following targets:

- Promotion of the use of renewable energy
- Participation of as many people as possible in the company and profit
- Combination of ecology and economics instead of profit maximisation
- Keep the company free from heteronomy by high finance, politics and industry
- Further development of the company in manageable steps on a solid basis
- Contribution to a preferably quick replacement of fossil energy by renewable energy

The limited company (GmbH) was very quickly turned into a stock corporation as the company (plants, generation of electricity, turnover) grew rapidly. Meanwhile the company operates plants in Austria, Germany, Czech Republic and Italy – in total 131 power plants – until now mostly windmills but also some hydroelectric power and solar electricity plants.

The WEB AG (corporation) mainly deals with

- Installation and operation of windmills as well as consultancy in all technical matters in this regard and
- Installation and operation of other renewable energy production plants mainly for the production of electric energy out of solar energy and small hydroelectricity.

The vote is exercised according to the par value of the share (i.e. 100,-EUR enable the right for one vote). In case a shareholder owns more shares the vote is limited – it can only be exercised up to 10% of the basic capital.

Company value per share:

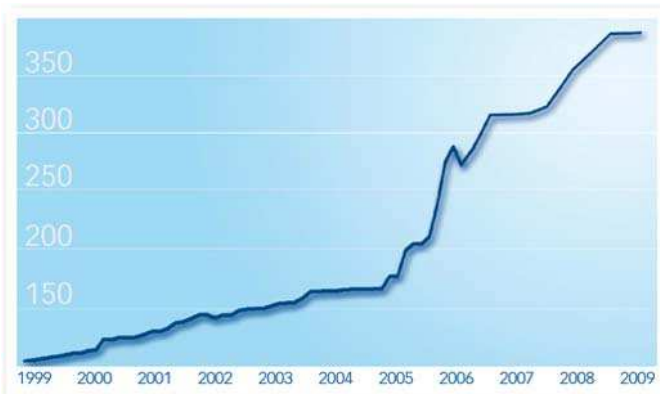

Progress from the founding of the corporation in July 1999 until June 2009

OUTCOMES:

WEB – actual data:

- 131 power plants
- 202 MW total power
- 1.532 kWh annual generation of electricity per share
- 3.033 participants
- 27.450.000 EURO basic capital

2.3.2.2 The actual planning for a regional energy contracting model LOCOMOTION – Local Contracting Motivation

The overall project objective is to make better use of the market potential for energy contracting activities by tailoring an approach to reach also smaller potential clients. This requires:

- Giving motivation and clear motives to all relevant actors groups in the region via advice, workshops, best practice examples
- Forming a regional LoCoMotion team by including members of these groups
- Developing the local contracting model – with a common scheme and local specific features
- Developing of min. 3 pilot projects – with local actors – in the region
- Carrying out and evaluating the pilot projects
- Developing the strategy and the plan for dissemination – the step from pilot projects to the alive model for the region

LoCoMotion is to create an innovative **LOCOMO (LOcal COntracting MOdel)** on paper and in reality in the region. In practical work market barriers hindering a broader use of energy contracting have been identified and a strategy was elaborated to overcome them, creating demand for energy efficiency and RES investment. The LOCOMO shall thus raise energy efficiency of buildings and plants and use of RES.

In the region there will be a LoCoMotion team elaborating their regional LOCOMO. Initiators from the region will form and organize this regional LoCoMotion team, consisting of the relevant market actors and experts from the fields of advice, planning, construction, technical services, financing, marketing, PR. They will bring the message of the LOCOMO to the owners and users of buildings and plants and they will develop, implement, evaluate and disseminate pilot projects.

The benefit from carrying out this project is the gathering and the joint utilisation of detailed knowledge and experience gained in the region. Building up regional energy contracting strategies on a good common base will firstly improve quality and secondly reduce costs.

Regional LoCoMotion contact points as central turntable and coordination base will offer independent advice, project development and controlling expertise. Regional banks will act as partners – energy contracting will be improved as a product tailored to the needs of the region, the target group shall be professionally addressed and so the message of the energy contractors will be taken notice of more than it used to.

LoCoMotion is packaging the complex (mostly too complex) collection of benefits, interests, possibilities of energy contracting into a good manageable LOCOMO and will besides also assist the idea of regional circulations. LoCoMotion supports much more the idea of collaboration than of competition for a real win-win situation – by application of experience and special knowledge – from pure technical and economical issues up to marketing and mediation (conflict management).

LoCoMotion is not just the train station, where the journey toward a second generation of energy contracting starts, but also comprises the vehicle for this process - the LOCOMO. The regional LoCoMotion team will build this train and heave it on its rails and start it.

OUTCOMES:

The project intends to set up regional network, contact points and conceptions for the broader and better use of energy contracting. In detail it will create the following outputs:

- network
- contact points
- regional policy
- pilot projects – min. 3
- awareness
- knowledge base useful for large-scale follow-up activities.

The main indirect result of the project will be investment into buildings and plants independently from the owners' equity structure. As experience from large urban building and public lighting operators prove, the large unused market potential for energy efficiency measures can to a high extent be utilized by efforts to foster energy contracting.

2.3.2.3 Regional Energy Round Table in Waldviertel

The regional energy round table in the Waldviertel is a free platform of dedicated private persons, the platform started in the micro region Thayaland. Some of the persons deal with energy directly or indirectly also in their job, in total the motivation for the participation is very different.

The energy round table comes together once a month and on October 1st, 2009 it celebrates its jubilee of the 100th meeting. During the meetings there are always one or more input presentation from experts to the daily topic followed by motivated discussions amongst the participants. In these discussions knowledge and experiences are exchanged, common ideas emerge and often also concrete cooperations.

Some of the regular visitors of the energy round tables were involved in the formation of the WEB corporation (AG) from the very beginning – please see separate description. The WEB corporation (AG) operates meanwhile also 5 small hydroelectric power plants.

Another showcase from the energy round table is the solar electricity project on the roof of the Waldviertler Schuhwerkstatt (shoe factory). In this project private capital was organised in a very creative way for the realisation of a photovoltaic plant. So far more than 1.000 persons gave the owner of the shoe factory 200,-- Euro cash each. By means of this money the plant was built and is being enlarged for the fourth time. For the compensation there are two possibilities:

- Persons, that participated in the first years, receive vouchers for shoes in the shoe factory for 360,-- Euro in total within 10 years.
- The new model works as follows: The persons receive a yearly interest rate of 4% fix. This interest is paid out each year.

At least once a year small hydroelectricity is topic during the regional energy round table.

OUTCOMES:

In a relaxed private atmosphere there emerge information flow, networking and cooperations besides the classical project course and actions. On the one hand it is an optimal addition to the other energy activities in the region and on the other hand it is again and again medium and basis for new ideas, appendage and realisation.

SMART
Strategies to Promote Small Scale
Hydro Electricity Production In Europe

WP 3 – Deliverable D3.1
Policies, methodologies & tools that may support decision makers in
implementing Small Scale Hydro Electricity Plants

**Guidelines and Tools for a
Technical and Economic Evaluation of
Small Hydro Electricity Plants construction**

Chapter 3.1 NTNU, Norway



Grant Agreement EIE/07/064/SI2.466791 -SMART

Table of contents

Summary -----	4
3.1.1 Choice of turbine, pipes and valves -----	5
3.1.1.1 Annual mean flow rate in a river/stream-----	6
3.1.1.2 Average flow capacity-----	8
3.1.1.3 Pressure head-----	9
3.1.1.4 Power-----	10
3.1.1.5 Duration curve and service life-----	11
3.1.1.6 Energy production-----	13
3.1.1.7 Estimation of income on the basis of energy production-----	14
3.1.1.8 Description and area of use for the different turbine types-----	15
3.1.1.9 Choice of turbine type-----	17
3.1.1.10 Penstock-----	18
3.1.1.11 Design pressure for pipe-----	20
3.1.1.12 Choice of pipe type-----	21
3.1.1.13 Choice of valves-----	21
3.1.1.14 Intake to penstock-----	24
3.1.2 Registration and Identification of Licensees and Interested Parties -----	26
3.1.2.1 Establishing an overview over the licensees in question-----	26
3.1.2.2 Informing the population about the possibilities in exploitation of the resources-----	27
3.1.2.3 The establishment of a database of the interested parties and available plants-----	28
3.1.3 New Technology – Description and Possibilities -----	29
3.1.3.1 The development of turbine technology-----	29
3.1.3.2 The development of pipes-----	33
3.1.3.3 The development of generator technology-----	33
3.1.3.4 The development of monitoring technology-----	34
3.1.3.5 Remote control of the power plant-----	34
3.1.4 Analysis of resources in the lateral watercourses -----	35
3.1.4.1 Map based survey of lateral watercourses that are theoretically viable – stage 1-----	36
3.1.4.1.1 <i>Restrictions for hydropower development in protected watercourses</i> -----	37
3.1.4.1.2 <i>Estimation method</i> -----	37
3.1.4.2 Computing the theoretical/economical available potential considering mini and micro power plants – stage 2-----	39
3.1.4.2.1 <i>Head</i> -----	39
3.1.4.2.2 <i>Catchment area</i> -----	39
3.1.4.2.3 <i>Averaged flow capacity</i> -----	40
3.1.4.2.4 <i>Service life and duration curve</i> -----	40
3.1.4.2.5 <i>Effect, energy production, pipe diameter, and design pressure for pipes.</i> -----	40
3.1.4.2.6 <i>The costs of building and construction</i> -----	40
3.1.4.2.7 <i>Costs of mechanical works</i> -----	50
3.1.4.2.8 <i>Cost of electrical work</i> -----	78
3.1.4.2.9 <i>The cost of engineering and project management</i> -----	87
3.1.4.2.10 <i>Annual costs</i> -----	87
3.1.4.2.11 <i>Economic life</i> -----	87
3.1.4.2.12 <i>Financing strategy</i> -----	87
3.1.4.2.13 <i>Revenue assessment –value of energy based upon market analysis or demand capability</i> -----	87
3.1.4.2.14 <i>Financial analysis and criteria for decision</i> -----	89
3.1.5 SHP program tools for Cost/ benefit analysis -----	93
3.1.5.1 SHP programs, methodology-----	93
3.1.5.1.1 <i>Cost of the small hydro power plants components</i> -----	94
3.1.5.1.2 <i>Variables of the programs</i> -----	99



Policies, Methodologies & Tools to Improve the Exploitation of SHP

3.1 NTNU, Norway

3.1.5.2 SHP Global view, user manual -----	100
3.1.5.3 SHP Individual view: cost of each component, user manual -----	102
3.1.5.4 SHP optimisation program, user manual -----	103
3.1.6 References -----	108

Summary

Chapter 3.1 is the norwegian contribution of deliverable D3.1 of the European Project named SMART. It contains guidelines and tools for a technical and economic evaluation of SHP construction.

Three user friendly program tools are developed at NTNU in order to simplify the task of discovering potential profitable SHP projects. These are presented in chapter 3.1.5. In particular the SHP optimisation program, which is the most advanced of the three programs, proved to be very useful for a preliminary technical and financial study discovering potential profitable sites for SHP construction.

The program tools, are basically based on the methodology described in chapter 3.1.1 and 3.1.4, but they are made so that default values easily can be adjusted to fit the case you want to study. The importance of presenting the input parameters for the projects together with the results needs to be stressed. The program tools were tested on the pilot region of Holtålen and the results are presented in deliverable D4.1 in work package 4 of the SMART project.

3.1.1 Choice of turbine, pipes and valves

This chapter gives a short description of the process on deciding the right dimensions on pipes and valves and choice of turbine type. One method to do an optimizing of flow rate through a power plant, is an economical consideration where weigh out income against/towards investments and expenses. These calculations are demanding and not described here.

A SHPP has a similar structure as that shown in Figure 3.1.1.0.

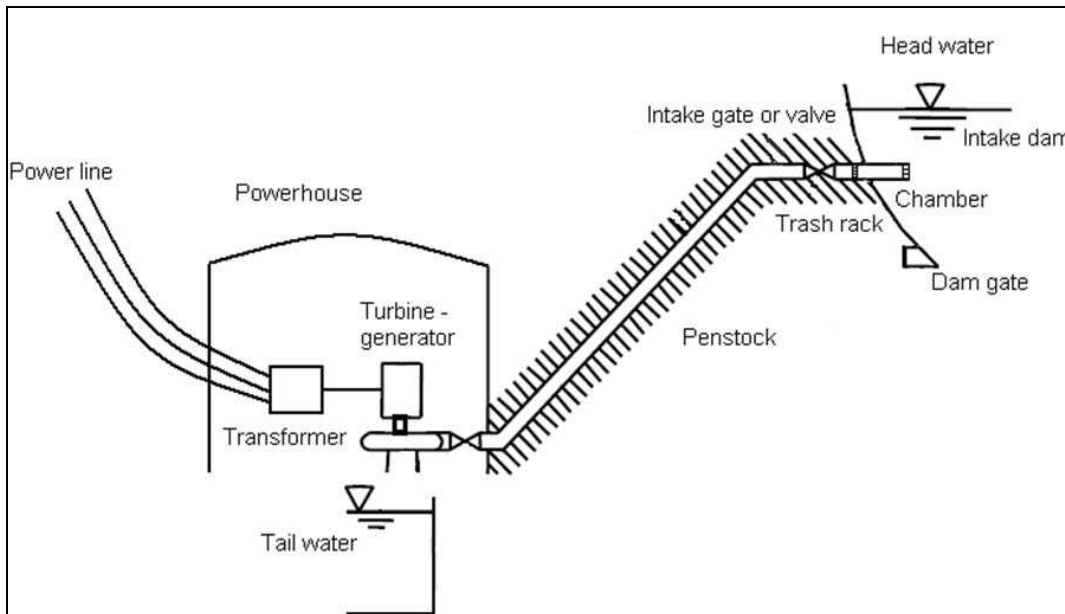

Figure 3.1.1.0: Small hydropower plant with a Pelton turbine

Every hydro power plant is customised; therefore one can not without further investigation choose the same pipes, turbine, valves, generator etc. as in another power plant. It is recommended to employ professional counselling to do this work as it turns out that many builders have made invidious choice during development of mini- and micro power plant. However, it is no wrong in doing this on is own if requisite knowledge are available.

Pressure head and flow rate are the two vital parameters for the choice of size on most of the components in the power plants. Based on these factors, the dimensions on pipes, valves and turbines are selected. The list below indicates the topics that are important to know about, together with the procedure on building a power plant.

1. Annual mean flow rate in a river/stream
2. Averaging flow capacity
3. Pressure head
4. Power
5. Duration
6. Energy production
7. Estimation of income on the basis of energy production

8. Description and area of use for the different turbine types
9. Choice of turbine type
10. Penstock
11. Design pressure for pipe
12. Choice of pipe type
13. Choice of valves
14. Intake to penstock

3.1.1.1 Annual mean flow rate in a river/stream

Flow rate is an important parameter for calculation of power and production. It is a bad economical investment to install a too big turbine that rarely can be run at full load. On the other side, it is unprofitable to choose a turbine that produce less then the available production/potential. However, it requires a lot of work to calculate the flow rate in a river/stream, and this chapter describes a method to find the annual mean flow rate.

Drainage basin to a river/stream is the area that have outflow to the river/stream, i.e. the area that has a gradient in the direction of the intake. Not all the precipitation fall within this area will reach the intake since some of the rain will evaporate or be taken of/by the vegetation.

The outflow/outlet/drain from the drainage basin is a part of the precipitation that finds the way to the intake. The size of the outflow depends primarily on the drainage basing size and precipitation, but also of soil condition, climate, vegetation and topography. The outflow will usually correspond to 70-9% of the precipitation in the area.

The area of the drainage basin are found from the suitable topographic maps with scale 1:50 000 (M711-maps). These maps have grids, where the area in each window is 1 km². The drainage basin is drawn by following the drainage divide towards the neighbouring area.

The drainage divide is the periphery between rivers water supply areas (drainage basin). The line that will be drawn will follow peaks and range of hills, and go across the contour lines. After sketching the drainage basin at the map, the area is calculated by for example a planimeter or counting grid windows. A planimeter is an electrical instrument which calculates the size of drainage basin by guide a sensor along the drainage divide lines on the map.

The next step is to find **the annual mean water run-off** from a water run-off map (isohydat map). Figure below shows an example on this map type.

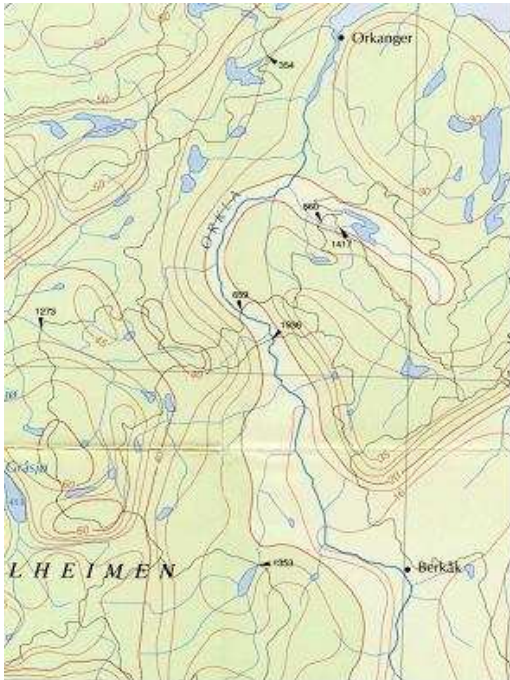

Figure 3.1.1.1: Isohydat map for a small section of South-Trøndelag

Isohydat map can be bought at Section of Hydrometry at NVE in Oslo, and cost about 125 NOK. The scale on an isohydat map is 1:500 000. The drainage basin that are drawn on a 1:500 000 maps have to be converted to an isohydat map. Contour lines on the isohydat map indicates constant annual water run-off. These are called isohydates. The isohydates indicates annual water run-off in litre per second per square kilometre. Probably will the drainage basin in your case exceed several isohydates. The challenge is to find how large sections of a drainage basin that lies within the respectively isohydates.

Current problem can be explained by an example. The example below shows how you can find the annual mean water run-off even if the drainage basin exceeds several isohydates.

Example

40 % of the drainage basin lies within 24 l/s km²:

$$\text{Annual mean water run-off} = 0,4 \cdot 24 \text{ l/s} \cdot \text{km}^2 = 9,6 \text{ l/s} \cdot \text{km}^2$$

10 % av drainage basin lies within 26 l/s km²:

$$\text{Annual mean water run-off} = 0,1 \cdot 26 \text{ l/s} \cdot \text{km}^2 = 2,6 \text{ l/s} \cdot \text{km}^2$$

50 % av drainage basin lies within 28 l/s km²:

$$\text{Annual mean water run-off} = 0,5 \cdot 28 \text{ l/s} \cdot \text{km}^2 = 14,0 \text{ l/s} \cdot \text{km}^2$$

TOTAL Annual mean water run-off:

$$9,6 \text{ l/s} \cdot \text{km}^2 + 2,6 \text{ l/s} \cdot \text{km}^2 + 14,0 \text{ l/s} \cdot \text{km}^2 = 26,2 \text{ l/s} \cdot \text{km}^2$$

The equation below shows how you find the annual flow rate by means of quantity of annual mean water run-off.

$$\text{Annual mean flowrate [l/s]} = \text{Drainage basin [km}^2\text{]} \cdot \text{Annual mean water runoff [l/s} \cdot \text{km}^2\text{]}$$

The example below shows calculation of annual mean flow rate.

Example

Annual mean flow rate per square kilometre is 26,2 l/s·km²

Drainage basin area is 5 km².

$$\text{Annual mean flow rate [l/s]} = 5\text{km}^2 \cdot 26,2\text{l/s} \cdot \text{km}^2 = 131\text{l/s}$$

If the annual mean flow rate differs from the flow rate which one has permission to use, you have to use the allowed flow rate in the calculation to obtain the right turbine. For those who has not applied for permission, the annual mean flow rate can be use to find the potential in the river/stream

3.1.1.2 Average flow capacity

Average flow capacity is the flow rate which the concessionaire is decreed not to go below. However, during the year the natural flow rate in the river/stream may be less than the averaging flow rate.

After determination of the averaging flow rate these parameters will be considered according to the size of averaging flow rate:

- Biology/ecology. The flow rate can be determining for the biological processes together with the ecosystem character and progress.
- Aesthetics.
- Variation of temperature at flow rate reduction.
- Ice formation.
- Sediment conditions.
- Quantity of production in power plant.

By inquire to NVE you can get information on how much the averaging flow rate should be. In most of the rivers in Norway 10% of the annual mean flow rate have been used as averaging flow rate.

Average flow capacity goes through a separate hole in the intake dam, and is explained further in point 14.

3.1.1.3 Pressure head

Pressure head is the difference in altitude between the water surface in the intake dam and tail water. The tail water is where the water leaves the power plant downstream. The tail water can be several metres lower than the power plant. In advance one needs to find a suitable place to build the intake dam and power plant. Figure 3.1.1.2 illustrates the pressure head.

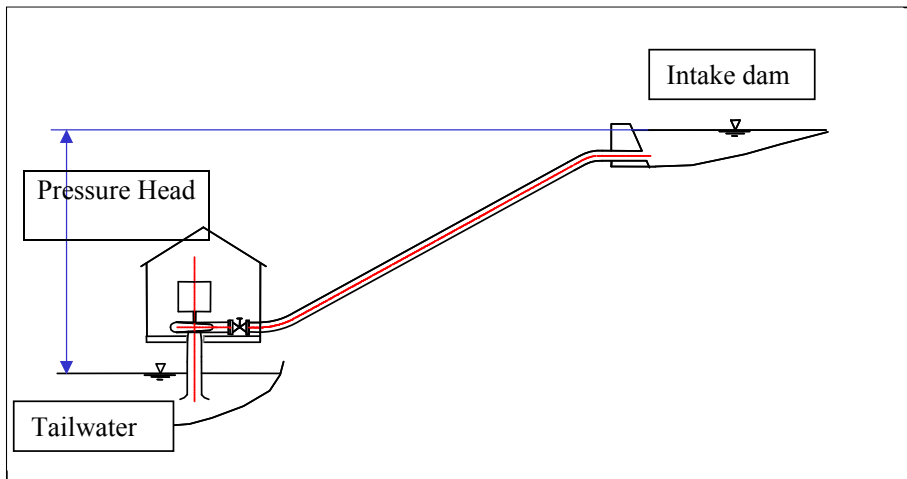

Figure 3.1.1.2: Pressure head

Pressure head can be found with different degree of accuracy. Four various methods to find the pressure head are described below.

1. **M711-map series.** By using M711-map series with scale 1:50 000 it is possible to do a coarse calculation on the pressure head to the power plant. The equidistance on this map series are 20 metres and that denotes a very inaccurate calculation of the pressure head. The equidistance is the constant altitude difference between the contour lines on the map.
2. **Economic power plant.** For a more exact estimate of the pressure head, it is recommended to use Economic power plant which have a scale 1:5000. The local governments in Norway shall have Economical power plant which covers most of the area in the municipality. The equidistance for these maps is 5 metres.
3. **Measurement of head with pressure gauge.** Pressure gauge is an instrument that measure pressure for example in [Bar]. From method 1 you find the head by a coarse estimation/calculation. Pressure gauges are divided into groups depending on what pressure they measure. After calculating a coarse head estimate, you choose a pressure gauge.

Example: If you want to measure a pressure head at 50 metre, a manometer for measure range of 0-6 Bar have to be used.

1 Bar \approx 10.18 metre water column

In addition to a manometer a plastic tube are needed. The length of the tube should have a range from planned intake dam to planned tail water. The diameter can be at the same size as

a garden hose. Attach the tube at the intake dam and lay the tube along the planned pipe trace. Fill the water with water and avoid air in the tube. Connect the manometer to the tube and read the meter near the tail water level.

Example: If the manometer displays 4.5 Bar this correspond to a head of:

$$Head = 4.5 \text{ Bar} \cdot 10.18 \text{ mVs} / \text{Bar} = 45.81 \text{ mVs}$$

Since the water is at rest, there are no head losses in the tube. Thus the method will give the gross head. To get a precise net head, head losses due to friction in pipes, pipe bends, valves etc. have to be deducted.

4. **Levelling.** To carry out this method a levelling telescope and a pole are needed. By means of trigonometry the difference of height are calculated. Contact the technical office in the local council, contractors, and land surveyor etc. to do this service.

3.1.1.4 Power

To find potential for a power plant you need to decide the power for the turbine and generator. These are estimated by head and flow rate, and the theoretical power are calculated by the formula:

$$P = (Q - Q_{\min}) \cdot H \cdot 9,81 \cdot \rho$$

where

- P is the power [W]
- Q is flow capacity [m^3/s]
- Q_{\min} is averaging flow capacity [m^3/s]
- H is gross head [m]
- 9.81 is force of gravity [m/s^2]
- ρ is the water density [kg/m^3]

Always allow for losses through a power plant. In these calculations the losses are not included. The technical language gross and net head are often used terms. *Gross head* is the same as the difference of altitude between the pipe intake and the turbine intake. *Net head* is the gross head minus the friction losses in the pipes. In a power plant losses in turbine and generator are also taken into account. The net power from the generator is dependent on the plants efficiency.

Example:

Flow rate = 0,1375 m^3/s

Head = 25 m

$$P = (0,1375 \cdot 25 \cdot 9,81 \cdot 1000)W = 33722W$$

Flow rate = 0,025 m^3/s

Head = 137,5 m

$$P = (0,025 \cdot 137,5 \cdot 9,81 \cdot 1000)W = 33722W$$

As shown in the examples, the order of the factors in the equation gives no differences. On the other hand, the factors are not unconcerned for the operation and economic of the power plant. Naturally, it is the conditions on the location that have the vital importance for the decision of the head and flow rate. The key to success is an accurate evaluation of these factors, as a part of the whole. A power plant is long-termed investment, thus it is important to know about the consequences of choice of equipments. By preference, the power plant should have a short payment period and thereby ensure good revenue the next ten years.

Classification of power plant:

The size of the power plant is dependent on how much power it is possible to generate from the available head and flow rate. When deciding the size of the plant, you have to accomplish an estimation of the power it is possible to achieve. The power equation at previous page can be used, and an efficiency of 100% is assumed. Since the efficiency is unknown for the power plant, it is easiest to presume this.

Next, the power plant is classified after these criteria:

- Power less than 100kW: Micro power plant
- Power greater than 100kW and less than 1000kW: Mini power plant
- Power greater than 1000kW: Small power plant

3.1.1.5 Duration curve and service life

In the process of planning a power plant, firstly an inspection of the hydrological conditions has to be carried out. This is done by mapping the flow capacity from the drainage basin. The flow rate varies from year to year, from place to place and also has a skewed distribution within the year, and therefore makes the mapping a challenging job. In many of the smaller power plants in Norway the flow rate are extremely changeable, thus it is important to look at the flow rate distribution during the year. A duration curve relates to the hydrological conditions, accordingly the amount of water available at every period. This is the basis for the choice of the maximum operating flow and thereby the expected energy production to the power plant. Figure 3.1.1.3 indicates a general example of a duration curve. The curve shows the duration of time the flow capacity has a value that is higher than a certain value. The flow rate data are sorted from top to low value.

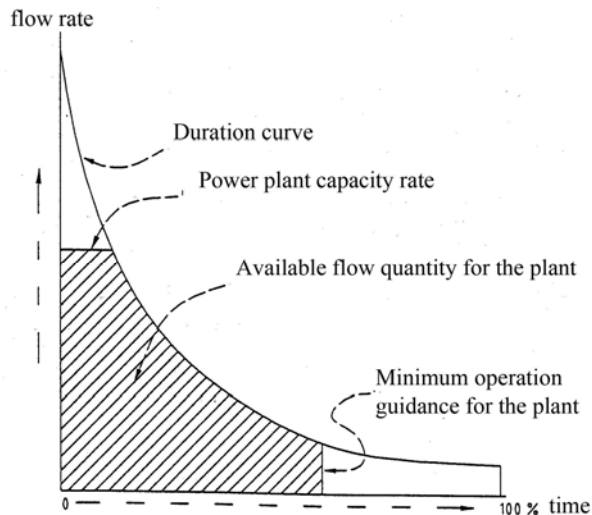

Figure 3.1.1.3: Duration curve

Over the last years, a lot of energy is put on mapping the flow rate in Norway. The hydrologic department at The Norwegian Water Resources and Energy Administration (NVE) has set up metering stations in different water courses in Norway. One can easily get the water level and draw a duration curve. Unfortunately it is no metering station in the smaller rivers and stream. To get the duration curve for these rivers/streams, one needs to scale down values from another station nearby. It is required that this station has a drainage basin with the following scaling factors:

- Altitude above sea level
- Vegetation
- percentage share of moor
- percentage share of lake
- terrain formation/topography

The Norwegian waterway- and electricity board, NVE, performs these kinds of scaling. A duration curve cost about 1000-2000 NOK. NVE are able to perform duration curves for:

- the whole year
- each quarter of the year
- every month
- a optional season

Service life corresponds to the number of hours the power plant produces at best efficiency point. The service life for an installation is found at the duration curve. On a duration curve for a river/stream, the value for annual averaging flow rate can be marked at the ordinate axis (vertical axis) which shows the flow capacity. At the abscissas axis (horizontal axis) the useful life time can therefore be read off. In point 7 “Estimation of income on the basis of energy production”, the calculation of income from production is explained. A process where service time and flow capacity are optimized, gives highest income from the power plant. It is important to take into account the difference in electricity prices at summer and winter. During the winter the flow capacity is at the minimum, but the electricity prices are high.

3.1.1.6 Energy production

Energy utilized in a hydro turbine. The pressure- and velocity energy in the water are utilized in the hydro turbine. In the penstock, water is stacked in the height. Since a turbine pipe is always filled with water, the water pressure will therefore be equal to a vertical water column. The height of the water column is the difference in altitude between the intake of the river/stream/reservoir and the placement of the turbine.

Energy production is calculated by multiplication of power and working life as showed in the equation below. The energy production is give in kilowatt-hours (kWh), thus the power are divided by 1000.

$$E = T \cdot \frac{P}{1000} \quad [\text{kWh}]$$

where

E	=	Energy production	[kWh]
P	=	Power	[W]
T	=	Working life	[h]

Example

Power, P is 33722 W

Working life, T is 8760 hours

$$\left(\frac{33722 \cdot 8760}{1000}\right)kWh = 295404kWh$$

This is the energy the waterway can produce if the whole run-off passes the turbine. The flow rate is assumed to be evenly distributed through the year, which require a good storage capacity (20-40% of the annual precipitation). Then the turbine can produce at full load the whole year, 8760 hours.

In case the flow rate can not be regulated (equalized) by the magazines it will constantly vary after the weather conditions. As mentioned earlier, due to flood periods will the flow rate be below the middle value over half of the year. If this is the case, and a turbine, which are dimensioned for a flow rate equal the middle flow rate and a power production of 33.7 kW in 4 months, 22 kW in 4 months and 12kW in 4 months, are chosen, the calculation look like this:

Example

33,7 kW in 4 months = 33,7 kW x 2920 hours = 98 404 kWh

22,0 kW in 4 months = 22,0 kW x 2920 hours = 64 240 kWh

12,0 kW in 4 months = 12,0 kW x 2920 hours = 35 040 kWh

Annual production: 98 404 + 64 240 + 35040 = 197 560 kWh

As a comparison as the example ahead, one can install a turbine dimensioned for half the flow rate. When the power supply is 16kW in 8 months, and 11kW in 4 months, the energy production will be:

Example

16,0 kW in 8 months = 16,0 kW x 5840 hours = 93 440 kWh

11,0 kW in 4 months = 11,0 kW x 2920 hours = 32 120 kWh

Annual production: 93 440 + 32 120 = 125 560 kWh

These calculations shows:

- A large storage capacity and a turbine designed for mean flow capacity delivers 295 404 kWh, which utilizes 100% of the annual run-off.
- No storage capacity and same turbine delivers 197 684 kWh, which utilize 67% of the annual run-off.
- No storage capacity and a turbine designed for half of the mean flow capacity delivers 125 560 kWh, which utilizes 43% of the annual run-off.

Even if the turbine size dimidiates, the annual production will not be reduces more than half, with the assumed power delivery and running period. Similarly, the annual production will not be doubled with a twice as large turbine. This is because the running period with full load is shorter. (More hours during the year with enough water for a small turbine but not for a large turbine.??) The duration curve can be used in these situations. The numbers in the examples will vary, dependent on how the flow capacity changes, but they are basically the same in unregulated river systems, large or small. Because of nature conservations or fishing, some places with much water can not be developed. A good solution is to take a small part of the flow capacity to produce power. This way much of the water will flow as usual, and the power station can run continuous on full load.

3.1.1.7 Estimation of income on the basis of energy production

The power plant income is calculated by:

$$1000 \cdot (Annualprod. - SC) \cdot spotprice + SC \cdot EPC$$

where:

Spot price is the energy price at the marked [NOK/kWh]

SC is self consumptions [kW]

EPC is the energy price for self consumptions [NOK/kWh]

Example

With an annual production of 295 404 kWh, the self consumptions are 200 000 kWh, the spot price is 0.2 NOK/kWh and the energy price for self consumptions are 0.6 NOK/kWh.

The income is:

$$((295404 - 200000) \cdot 0,2 + (200000 \cdot 0,6)) NOK = 139080 NOK$$

3.1.1.8 Description and area of use for the different turbine types

The three most common turbine types in small hydro power plants are Pelton, Francis and Kaplan.

Pelton turbine is utilized for high head combined with small flow rate. For small power plants, Pelton turbines are used for head over 30 metres. The Pelton turbine is a free jet turbine or an impulse turbine. That means that the water in the pipes is accelerated through a nozzle and the pressure energy in the water is converted to kinetic energy. The accelerated water from the nozzle hits the runner vane/buckets and the kinetic energy converts to rotating energy on the runner shaft. This occurs by deflection of the jet when it hits the vanes. The impulse of the jet is transferred to the runner and yields a rotational power. Only the three nearest vanes are hit by the jet and only these transfer the energy. Up to six nozzles can be used, and more nozzles enable better part load production. According to the power and efficiency, the available water amount is better utilized.

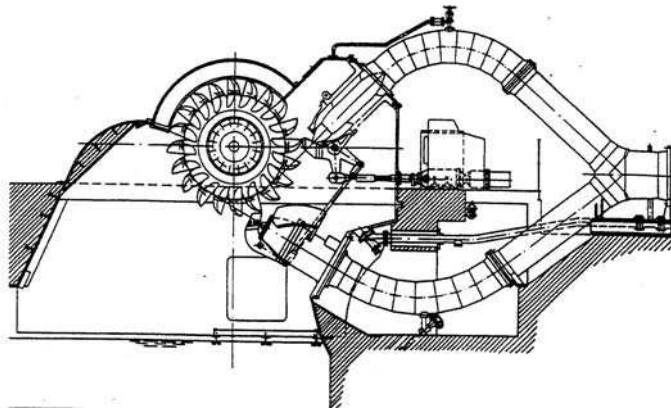

Figure 3.1.1.4: Pelton turbine with two nozzles

Francis turbine is the most common turbine and is used for head from 5 to 700 metres, with both large and small flow rate. Owing to the fact that the wicket gate channels and runner channels is filled with water under operation, the Francis turbine is a reaction turbine or full turbine. The pressure at the inlet of the runner is higher than the outlet. The spiral casing distributes the water uniformly into the wicket gates and further to the runner. The energy in the water is the sum of the pressure difference and reduction of velocity energy. The draft tube is placed after the runner and the difference in altitude between tail water and turbine is utilized. That means the draft tube height is very important for the energy conservation that takes place in the runner channel.

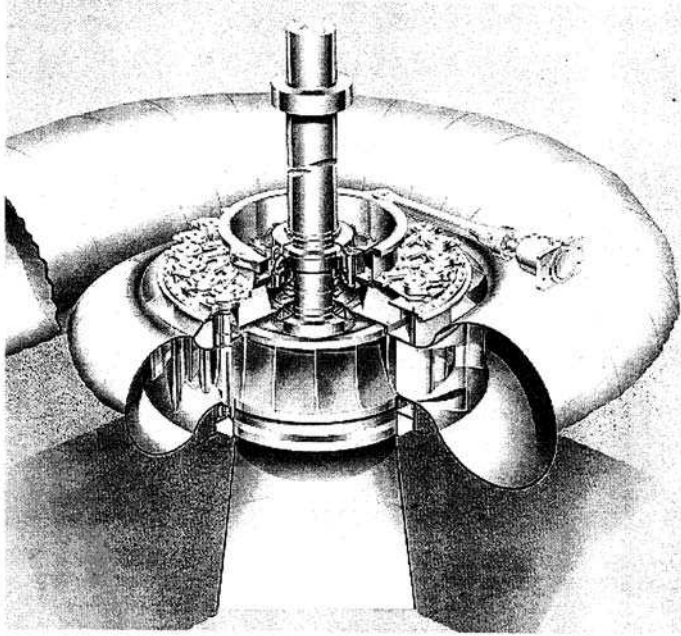

Figure 3.1.1.5. Francis turbine

Kaplan turbine is used at high flow capacity and low head. Like the Francis turbine, the Kaplan is also a reaction turbine. These turbines are relatively the same in design/shape, and the energy production is in principle the same. Kaplan turbines characterises with its *revolving rotating blades*, which gives high efficiency at variable flow rate and head. For rivers where the flow rate and head varies during the year, Kaplan turbines are the best choice.

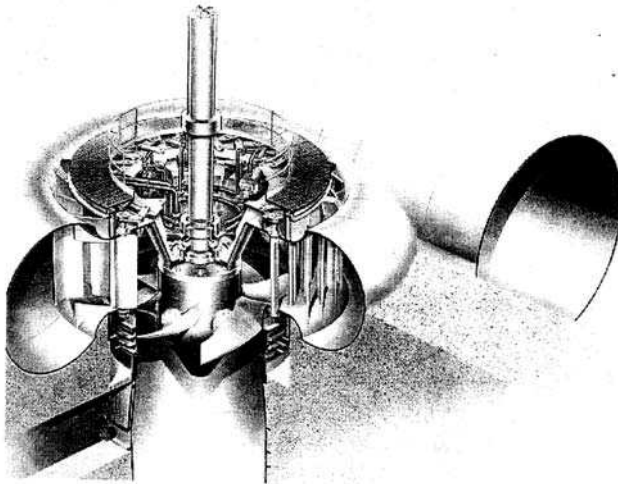

Figure 3.1.1.6. Kaplanturbin

3.1.1.9 Choice of turbine type

For every single power plant it is important to choose a turbine that is most suitable to make the most out of the flow capacity and head. **The speed number** is used to decide the turbine type in this project. The speed number is given by :

$$\Omega = \frac{\pi \cdot n}{30 \cdot \sqrt{2gH}} \cdot \sqrt{\frac{Q}{\sqrt{2gH}}}$$

Ω is the dimensionless speed number, n is the rotation speed on the runner [rpm].

The lower head, the lower speed number is chosen.

Example

Head, H is 25 m

Rotation speed, n is 750 rpm

Flow rate is 37,5 l/s which is equal to 0,1375 m³/s

The speed number:

$$\Omega = \frac{\pi \cdot 750}{30 \cdot \sqrt{2 \cdot 9,81 \cdot 25}} \cdot \sqrt{\frac{0,1375}{\sqrt{2 \cdot 9,81 \cdot 25}}} = \underline{\underline{0,28}}$$

The choice of turbine are base don the follow:

1. If the power, P is less than 1000 W:
 - Pelton turbine: speed number less than 0,15
 - Multi jet Pelton: speed number up to 0,2
 - Francis turbine: speed number between 0,15 og 1,5
 - Low- head Francis: speed number less than 0,2
 - Kaplan- or propeller turbine: speed number greater than 1,5
2. If the power, P , is greater than 1000 W:
 - Pelton turbine: speed number less than 0,19
 - Francis turbine: speed number from 0,19 to 1,5
 - Kaplan turbine: speed number greater than 1,5

Thus a Francis turbine is chosen in this example

3.1.1.10 Penstock

As mentioned earlier, pressure losses will occur in the pipe. As a consequence of the friction between the pipe wall and water, the pressure loss increases with the water velocity in the pipe. As opposed to what most people think, the velocity of the water is relatively low, around 1-3 m/s. It is easy to compare a turbine pipe with the open water channels which were used to operate the old grinding mills and saw mills. The aim of these open water channels was to gain high water velocities in such a way that the water had high impulse towards the water wheel. The hydro turbine uses the pressure energy in the water and it is desirable to have as little as possible loss of energy in the pipes. As opposed to water channels, the water velocity is low. Not until the water hits the turbine wheel the velocity increases. Depending on the pressure the velocities can be extremely high.

The pressure loss is dependent on these three factors, for given water flow per time unit:

- Pipe length
- Inner diameter of pipe
- Inside surface of pipe (smoothness)

Formulas or diagrams prepared by the supplier are used to calculate the different losses for various pipe material and manufactures. The losses are indicated by per thousand, number of millimetre head loss per meter pipe length.

A loss up to 10% of the head is usually accepted. As seen in figure 3.1.1.7 it is only the difference in height that forms the H in the output formula. The terrain profile has no direct impact on the head. The pipe may have sections lying higher than the intake (theoretical 10 metres are max), and the principle of siphon applies. Of practical reasons one should avoid this principle since it makes the pipe filling complicated. Besides the pipes need to be drained completely for water and the pipe should lie with downward gradient.

Pipe diameter:

To avoid large head loss in the penstock, the pipe diameter is calculated based on the maximum pipe water velocity (C_{max}) 3.0-5.0 m/s. The formula shows the calculation of the pipe diameter:

$$D_p = \sqrt{\frac{4 \cdot Q}{C_{max} \cdot \pi}} \quad [m]$$

D_p	=	Pipe diameter	[m]
Q	=	Flow rate	[m ³ /s]
C_{max}	=	Maximum flow velocity	[m/s]
π	=	3,1415	

Pipe length:

In principle one should choose a route which gives the shortest pipe length independent of the stream/river. The plumbing should also be easy. In cases where the ground conditions enables

for a pipe route with highest drop in front of the turbine, it may be profitable to utilize it even if the pipe length gets longer. The pipes will therefore be shorter and lie in the highest and most expensive pressure class.

The pipe length is based on the head and measured length from inlet to outlet from the turbine house.

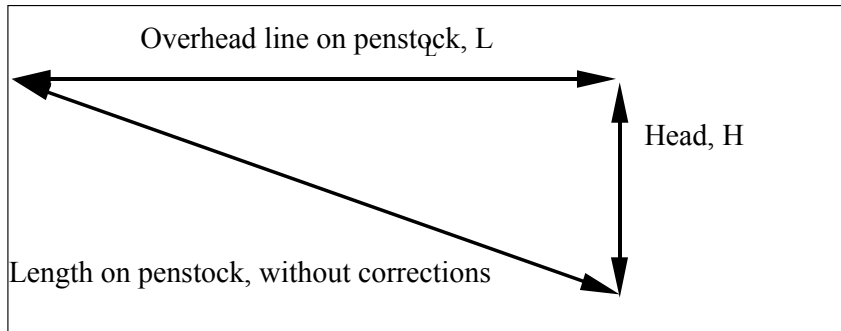

Figure 3.1.1.7. The penstock length in proportion to overhead line and head

The pipe length is calculated by:

$$L_p = Corr \cdot \sqrt{H^2 + L_L^2}$$

L_p	= Pipe length	[m]
Corr	= Correction factor	[-]
H	= Head	[m]
L_L	= Horizontal length of penstock	[m]

To correct for roughness in the landscape a correction factor is used. Assume that 10% increase in pipe length due to roughness in landscape this factor is 1.1.

3.1.1.11 Design pressure for pipe

When deciding pipe type and costs you need to find for what design pressure the pipe are dimensioning for. Head and pressure surge are two important factors. The pressure surge and design pressure are calculated with the equations below:

$$H_{ps} = \frac{a \cdot C_{\max}}{g} \quad [\text{mWc}]$$

where

H_{ps}	=	Pressure surge	[mWc]
a	=	Sound velocity in pipe	[m/s]
C_{\max}	=	maximum water velocity	[m/s]
g	=	gravitation	[N/kg]

$$H_{\text{design}} = H + H_{ps} \quad [\text{mWc}]$$

Where

H_{design}	=	Design pressure	[mWc]
H	=	H	[mWc]

In this project these values for sound velocities are used:

Pipe type	Pressure propagation
[-]	[m/s]
Steel pipe	700-900
GUP-pipe	600-700
PE-pip	300
Concrete pipe	1000-1300

3.1.1.12 Choice of pipe type

In connection with water, four different pipe types are employed.

- PE-pipe
- GUP-pipe
- Spirally welded steel pipe
- Prestressed concrete pipe

PE-pipe stands for polyethylene pipe and is used as much as possible. They are rather flexible and adapts with the ground. The pipes are easy plumbing and can generally lie directly on the ground without much preparatory work as ditches etc. PE-pipes are all-welded and tight, low weight, high strength and tensile strength connections. They are also resistant to most chemicals and fluids and are easy to maintain. Due to low roughness on the inside, the friction losses are considerable low compared to corresponding dimension of cast-iron and concrete pipes. The only possible method to increase the strength of the pipe is to expand the material thickness, though PE-pipes can be rather expensive. If PE-pipes are put direct on the ground be aware of ice issues.

GUP-pipe stand for glass fibre reinforced unsaturated polyester plastic and these pipes are rigid than PE-pipes. Owing to the fact that the GUP-pipes are constructed as a “sandwich”, the material does not need to be thicker when a higher strength is demanded. The layers can vary in number and thickness depending on your requirement. The layers consist of poles and armature.

When you need pipes that can yield high tensions, use spirally welded steel pipes. They are cheaper than both PE-pipes and GUP-pipes. However they are not as applicable as the PE-pipes when it comes to assembling and welding.

Pre-stressed concrete pipes are rarely, and are only used a few places in Norway. They are produced in Sweden, but the production will perhaps stop soon.

3.1.1.13 Choice of valves

The shut down components play an important roll in a power plant. A short description of valves is given in this section. The choice of type and number of valves depends on the type of power plants. The aim of the valve is to blind off or open for fluid in a pipe. For every purpose a valve that fulfil the requirements depending on dimensions, load, operating- and safety requirements and price.

For a long penstock it is suitable to have valves located two places on the penstock:

- **Valve in front of the turbine**

When the turbine is at stand still the valve is shut down in order to:

- Avoid standing pressure on the guide vane operating system, for high head of water, prevent the leakage water from guide vanes to damage the turbine. Only the leakage water may be sufficient to keep the turbine in rotation

- Prevent ice formation in the turbine; the ice may break the turbine.

-Empty the penstock for inspection of turbine.

- **Valve in upper part of the penstock**

This valve has following purposes:

-The penstock is closed by blinding off the water from any other headrace tunnel or direct from the intake dam

-For inspections and reparation of minor damage on the penstock

-Prevent flooding at pipe rupture. An own self-closing valve can be installed which will automatically close when the water velocity exceeds a certain value.

The movement of the valves is either done by manpower or an engine. Hydraulics movements are used for turbines that are often manoeuvred. Either oil or water can be used as medium

To open the valve in the penstock it is necessary to achieve equal pressure on both sides of the valve. For high pressures a by-pass valve is needed. At mini- and micro power plants this is not usually employed.

Many valve types exist, but the most common types are butterfly valves, spherical valve, gate valves and annular valves.

Butterfly valves

A butterfly valve has a round valve with an axle, a valve ring and a gate opening. The valve axle rotates on an angular axis on the pipe axel. Most of the butterfly valves is equipped with a weight arm. For small valves this weight arm is sufficient to close to valve at any conditions. The valves are suitable for water pressure at both sides.

The butterfly valve is employed for high flow amount and average head.

Pros:

Cheaper than ball valve

Cons

Sealing problems. This can be improved by using the water pressure to tight the seal faces together.

Losses due to disadvantageous flow conditions for deflection of water flow.

Ball valve

The ball valve has a closing unit which are turned on an axis perpendicular to the stream direction. This valve is different from others since it have a smooth and cylindrical sweeping which is levelled with the intake and outlet connections.

Pros:

The hydraulic losses are small. The loss corresponds to the pipe friction over the pipe length.

Small construction

Cons:

Expensive

Gate valves

The gate valves have in common the angular closing unit or sluice. When the valve is opened the sluice is pulled away from the waterway. The valve is self-sealing because the force that acts on the sluice from the water is directly transferred to the valve seat. Increasing water pressure gives increasing sealing pressure.

Cons:

- The losses reduce the water velocity
- Extensive construction
- Wear on sealing faces
- More expensive than butterfly valve

In Norway, gate valves for large dimensioned is no longer produced.
For smaller dimensions the gate valves are used as by-pass valves and discharge valve.

Today the gate valve is replaced with a ball valve as a shut down unit in front of the turbine.
The ball valve is more expensive but has fewer losses.

Annular valve

The annular valve has a piston formed closing unit which is displaced in axial direction at opening or closing. The closing unit consists of a piston with a piston rod connected with a cylinder. The valve house is formed as an expansion around the closing unit and form a circular flow area.

Pros:

- Good flow conditions with small hydraulic losses
- Can handle flow in both directions and is also suitable to pump storage power plants.

Cons:

Many annular valve utilizes oil for the manoeuvring, and require an own separate oil- or power unit.

When using oil a more complex emergency closing is necessary. Water control can complicate the closing process if the water consists of sand and mud.

Preferably annular valves are used at pump storage power plants.

The most common valves used at minor power plants are butterfly valves and ball valves.

Experiences from Kværner Bruk Inc, the range of:

Head 0-150 metres: Butterfly valves

Head 150-250 metres: Butterfly and ball valves

Head above 250 metres: Ball valves.

3.1.1.14 Intake to penstock

On principle should the intake be arranged in such a way that the water have an opportunity to “settle down” before entering the thrash rack. This is especially important for sand laden water. Another advantage with steady stream conditions by the intake is that the surface area near the thrash rack can be covered with ice. This will reduce the risk of frazil ice creation which may stick to the thrash rack and pack the entrance.

Further should the thrash rack placement be on the side of the river/stream, preferably in a channel as shown in figure 3.1.1.8. This is favourable with regards to leaf, branches and such which may float past the intake. In periods with flood this is especially important, but also for rivers/streams which are exposed for ice drift. Water intake from channel is a reasonable solution because most of the work is independent of flow rate in the river, and gives a minimal interference in the nature.

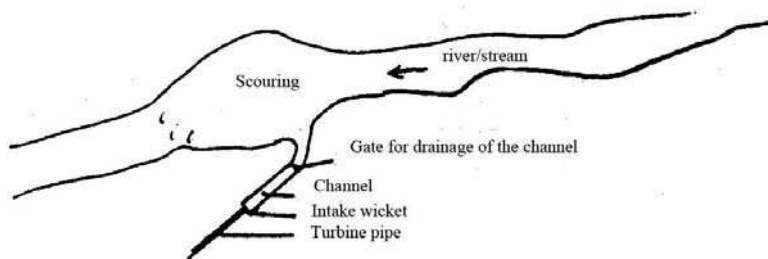

Figure 3.1.1.8: Intake at the side of the stream

Irrespective of type of water intake, the thrash rack should be placed as deep as possible, preferably 2 metre under the water surface. The reason for this is to get hold of the hottest water during the winter. At 4 ° C the water density is at its highest and heaviest. The heavy water will during the winter lie down on the bottom. When the intake is by a pond, lake or a regulation reservoir, the turbine pipe ought to be put as far as possible in the water so the thrash rack is sufficient submerged when the water level is at the lowest level. The gross head is dependent of the difference in height between the intake and tail water, so the depth of the thrash rack has on significant importance.

To ensure the decreed minimum release in the river/stream, one makes an outlet beneath the intake to the penstock. This outlet releases a water flow corresponding to the minimum release. See figure 3.1.1.9.

Possible running problems with the power plant can be attributed to poor intake conditions. Therefore it is worth the money to spend time to consider different possibilities to get an optimum intake. In case of the intake turns out to not work as expected, an improvement of an intake for a small power plant is not an expensive.

Dam

- Intake to turbine with thrash rack
- Secure of minimum release
- Prevent icing of intake
- Emergency gate



Figure 3.1.1.9. Dam to Glisja power plant in Soknedal

3.1.2 Registration and Identification of Licensees and Interested Parties

After the preliminary investigation and discovering of the potential sites for SHP development in the municipality of Midtre Gauldal, it was executed a process in order to register and identify licensees and interested parties who would want to establish mini and micro power plants in the municipality of Midtre Gauldal. In addition, it has been established a database which contains information about the individual mini and micro plant together with the appurtenant licensees and interested parties.

The background for this is that a number of licensees in Midtre Gauldal have shown interest to explore the possibility to establish mini and micro power plants in their lateral watercourse of Gaula. A number of licensees have also applied to initiate a mini and micro power plant in these lateral watercourses. Both the municipality of Midtre Gauldal and Gauldal Energy have assisted in these processes. It is a need to establish an overview over the resources in addition to the licensees and interested parties, to be able to optimise the utilisation of the available resources one has in the preserved watercourse.

3.1.2.1 Establishing an overview over the licensees in question

It was established an overview of a number of mini and micro power plants of interest, which are theoretically and economically available. From the Economic Map with a scale of 1:5000 one can find information about which licensee that owns the different rivers/streams. This process was naturally executed simultaneously with the mapping of the exact head of a river/stream, because both operations were performed on the same map. In the Economic Map it is listed the title and land numbers connected to the different properties, but there is not given any information about the owner. To retrieve the owners name and address one must use the GAB register. This is the most updated registry the municipality of Midtre Gauldal has on this territory, and the registry is continuously updated with information from the circuit judge. Name, address, title and land number to the licensee is registered in an overview in Excel format, saved on a CD and given to the local authorities in the municipality of Midtre Gauldal.

3.1.2.2 Informing the population about the possibilities in exploitation of the resources

In this overview it is put aside a column where one can tick off whether or not the licensee is interested in further follow-up. Through this project one has incidentally encountered licensees who would like further follow-up, but the project group has also arranged meetings with the licensees -something that will be further discussed in the next subchapter.

Up to this point, the project has been a map based study where the theoretically and economically available rivers/streams and the licensees to these watercourses are registered. To be able to map the interest of this project, the municipality of Midtre Gauldal has held four information meetings for landowners and the licensees. These were held respectively, in Soknedal, Budal, Støren and Singsås. The turn up for these meetings were rather good, and there was a great interest in the project. In short, the subjects that were brought up at the meetings:

- Orientation about the project.
- Economy, rating, electricity prices, grid access.
- The rule of thumb for calculations.
- The application procedure.
- A review of the technology (hydrology, inlet, penstock, turbine, expenses, etc.).
- The right choice of equipment.
- Control of purchases.
- Financing (SND - funds).

For those who did not have the opportunity to be present at these information meetings, were followed up with a letter from the municipality of Midtre Gauldal, in hope of increasing the number of interested parties. This letter included a short description of what that was reviewed at the information meetings, and in addition, general information about the project "Miljøtilpasset el-kraftproduksjon ved små vannkraftverk i Distrikts-Norge". At Singsås consumer co-operative and at the municipality of Midtre Gauldal, town hall, there was a possibility to register one self as an interested party. It did not accompany any obligation with this registration, but one had the possibility to receive follow-up through this project.

3.1.2.3 The establishment of a database of the interested parties and available plants

Based on chapter 3.1.2.1 and 3.1.2.2 it is established a database of the licensees and the interested parties. The data base contains the necessary key information about the mini or micro power plant in question, also information about the licensee and or the interested party. The database consists of tables, forms and surveys.

Table Four tables about the following topics have been made:

- Economy
- Landowners
- Technical data (Dimension data for the individual components of the power plant, for example pipes, generator, valves etc.)
- Background data (Corresponding dimensions which enters the effect calculations of the power plant)

The tables are linked to Excel sheets, which is a product of the work described in chapter 3.1.1 and 3.1.2.

The tables serve as a basis for making the surveys. The survey gathers information from tables.

Form The form is a clearer and more sorted presentation of the corresponding information one can gather from tables. A form has been made, which contains information about the landowner. Every river/stream is defined as an item and all the information about the river/stream in question, be effect, licensee, parties of interest etc is stored here. As one turn the pages in the form, item after item is presented.

Survey It has been made two surveys about effect. One can search for areas of effect by inserting a value, and as an output, all the rivers with a smaller or larger value than the one inserted. One of the surveys yields rivers which has a larger effect than the inserted value, while the other yields rivers has a smaller value than the inserted one.

It has also been made a survey based on the landowner, where one can search for the name of a river and find the landowner for the river in question.

Use of the Data base The database is stored on a CD and is only available for the municipality in the beginning. It is not possible to change the information on the CD, but it can be temporarily done on the computer where the information in question and the software is available.

It has been executed a process in order to register and identify licensees and interested parties who would want to establish mini and micro power plants in the municipality of Midtre Gauldal. In addition, it has been established a database which contains information about the individual mini and micro plant together with the appurtenant licensees and interested parties.

3.1.3 New Technology – Description and Possibilities

The hydropower technology is an expanding technology which has been developed for more than 100 years. The development has mainly concerned building larger and larger power plants with good quality, reliability and efficiency. The same technology is used in smaller power plants which results in expensive equipment. Therefore, many manufacturers have tried to simplify this equipment to reduce the production costs. Still, the technology that is available for the larger plant will also be available for smaller plants in the future. This chapter describes the latest known developments within hydropower.

3.1.3.1 The development of turbine technology

The turbines which are sold to mini and micro power plants are scaled down from larger turbines. This has resulted in a selection of good turbines at a high price. Therefore, many manufacturers in Europe and Asia have developed turbines which can be offered at a lower price. In the period when this project was executed, there was produced more and more turbines where the blades in the runner have cracked. In some of the cases have the blades fallen out of the runner and destroyed the runner completely. Unfortunately, this has led to economic losses for the developer. It is therefore warned against selecting a turbine solely based on the price.

The last technological development of Pelton turbines has lead to an efficiency of 92% from the best manufacturers. New automated production methods with welded hub and blade brackets are developed for Pelton turbines. Figure 3.1.3.1 illustrates how a welding robot can be used to produce the runner of a Pelton turbine. Figure 3.1.3.2 shows VA Tech's new development of a Pelton turbine for small power plants, where the hub is made of stainless steel and the blades are of plastic. These can be used for heads smaller than 400 meters. Also some small manufacturers, such as "Stjørdal 3D verksted" have went for production of plastic Pelton buckets for small and micro hydro power plants. The advantage of plastic buckets is that these are very cheap and easy to replace when broken. The consequences of broken buckets are also small.

More and more manufacturers also produce the Pelton runner milled out of welded or casted blocks for large turbines, to reduce the danger of dangerous welding errors.



Figure 3.1.3.1. Pelton production



Figure 3.1.3.2. Pelton blades of plastic

The Francis turbine has had a considerable development regarding efficiency, the choice of material and production methods. Lately, turbines which are delivered from GE Hydro, earlier Kvaerner, have obtained an efficiency of over 96% for the largest turbines. This is a result of cooperation between Kvaerner and the Water power laboratory at NTNU. The new developed blades in the runner have received the name “X-blade”. The name is due to the fact that the blades in the runner looks like an X when looking from the inlet edge in towards the outlet edge of the blades. Such a runner is shown in figure 3.1.3.3. It is expected that GE Hydro will use this technology in the turbines they deliver, also for smaller power plants. One can not expect an efficiency of 96% in a mini or micro turbine. It would be a very good and probably expensive Francis turbine if one can obtain an efficiency of over 90% for these small turbines.

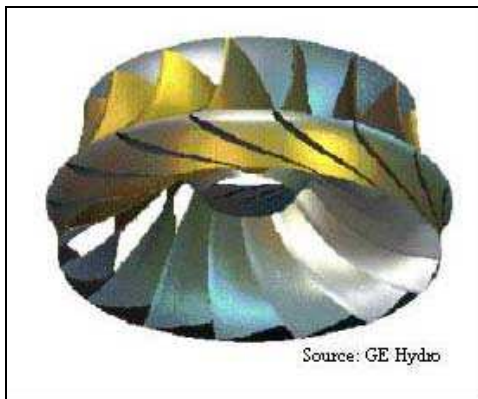

Figure 3.1.3.3. X-blade runner

Since 1958 and until 1980 has the weight of the spiral casing in the Francis turbine been reduced to 2/3. This is due to the change from casting to welding these spiral casings. Figure 3.1.3.4 illustrates that it is tensions in the materials that is used today. In the mean time the tensions are limited such that there will be leakages before fracture in the mentioned turbine. This is done to avoid catastrophic pipe fraction as in the power plant in Switzerland.

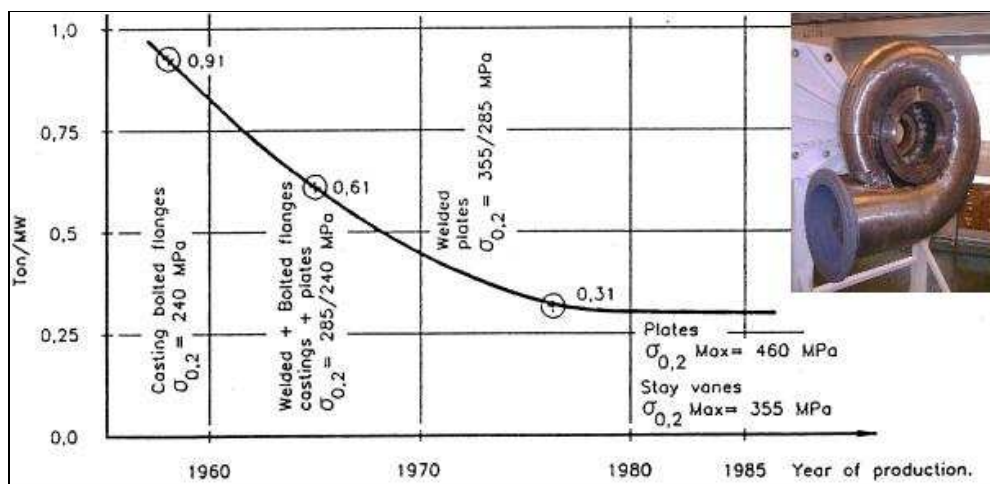

Figure 3.1.3.4. The reduction in weight for spiral casings for Francis turbines.

Kaplan turbines and Bulb turbines is often used in power plants where the head is low. These have had an improvement in the efficiency over the last 10 years, and the state of the art lies at an efficiency of about 95%. The development of these turbines has been the same as for Francis and Pelton where the production technology and the material technology are improved to reduce the production costs. One can not expect to achieve an efficiency of 95% in a mini or micro turbine. It would be a very good Kaplan turbine if one can obtain an efficiency of over 90% for these small turbines.

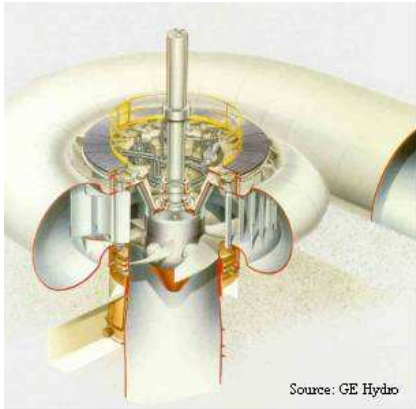

Figure 3.1.3.5: Kaplan turbine

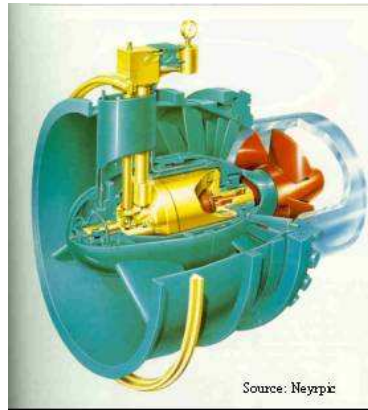

Figure 3.1.3.6: Bulb turbine

For use in the small power plants it has been made a Bulb turbine where the generator axel is drawn out through the suction pipe which results in an S-shape as shown in figure 3.1.3.7. Figure 3.1.3.8 illustrates how another type of simplified vertical bulb turbine with static blades in low pressure power plants can be installed.

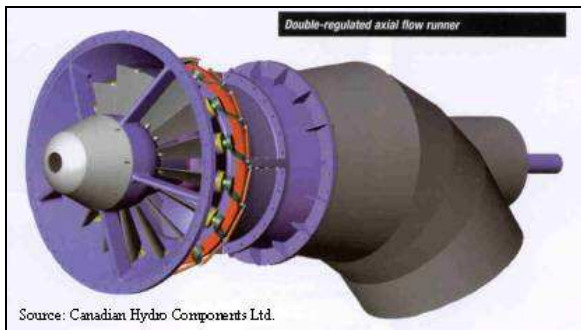

Figure 3.1.3.7: S-shaped bulb turbine

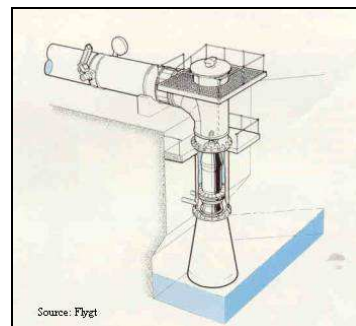

Figure 3.1.3.8: Flygt Rørturbin

The Waterpower Laboratory at NTNU has developed a Plate turbine which satisfies the requirements that are set for mini and micro turbines. The Plate turbine is a result of the need for a simple robust turbine for the developers of mini and micro power plants in Norway. This turbine is shown in figure 3.1.3.9 and 3.1.3.10. The turbine has a simple geometry which simplifies the production. It has also been tested at the Waterpower Laboratory and has proved an efficiency of 90%. It is therefore a very good alternative for those who otherwise

would have chosen a Francis turbine. However the water supply should be steady for plate turbines, as there are no guide vanes, and therefore the operational range is limited.

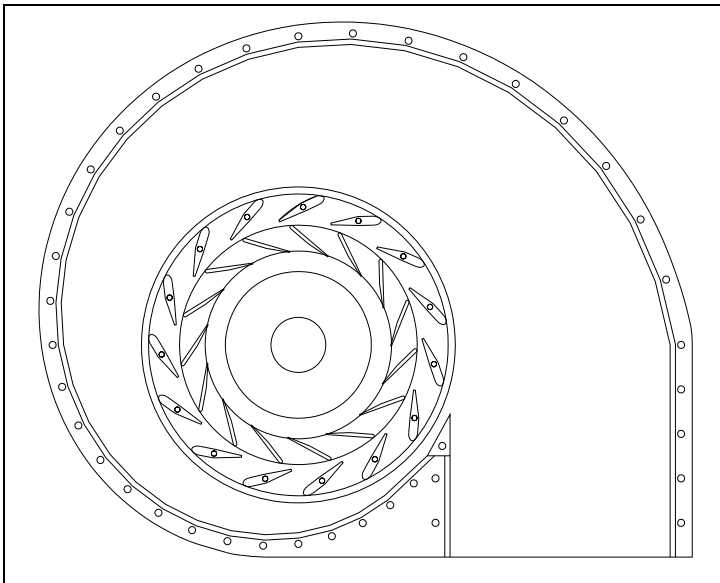

Figure 3.1.3.9 Radial cut of Plate Turbine

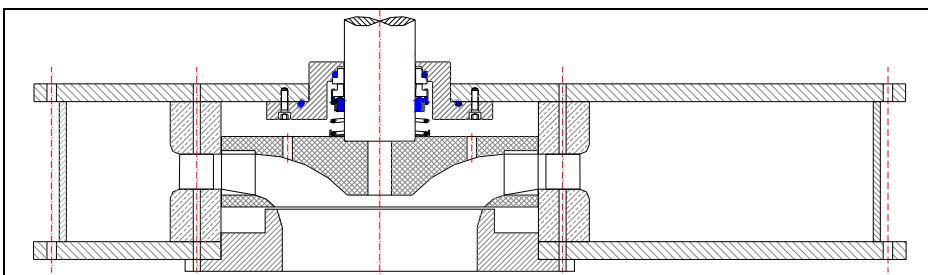

Figure 3.1.3.10. Axial section of Plate Turbine

Lately it has been written a lot about Cross-flow turbines. This turbine has a long history and is also known as Mitchell, Banki and Osberger turbine. This type of turbine is not to be regarded as a new developed turbine, and it is not able to measure up against Francis, Plate turbine or Pelton in efficiency. On the other hand it has been developed an outlet system which can control a under pressure. This will increase the efficiency, especially for turbines with a small head. It is also worth to mention that this turbine, if well designed, can be a good alternative in developing countries as it is very easy to produce, install and repair.

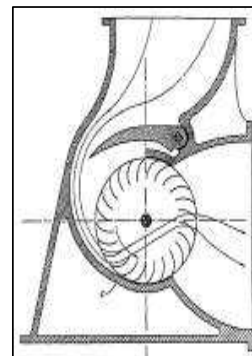

Figure 3.3.11 Cross-flow turbine

In USA it is a large focus on that fish should survive when they swim through a turbine. Voith has worked on developing a turbine which can allow fish to swim through without dying. One possible solution presented of Voith is shown in Figure 3.1.3.12. Such turbines are not installed in Norway. At the Waterpower Laboratory the opinion is that this type of turbine will not be used to a large extent, and it is not a viable alternative for mini and micro turbines. Such a fish friendly turbine is only necessary for river power plants.

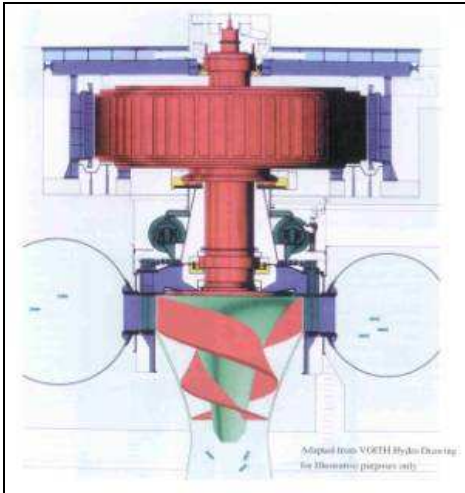

Figure 3.1.3.12 A possible fish friendly turbine

In many countries there are high amounts of sediments in the water, resulting in severe erosion of the runner. In aim to increase the lifetime of the runner, the fresh company Dynavec has started a new production method, that is to bolt the blades in the Francis runner. This makes it possible to fully coat the runner blades with a ceramic layer that protects it from sand erosion so the runner works longer and more efficient.

3.1.3.2 The development of pipes

Lately there has been introduced many different types of pipes which are well suited for mini and micro power plants. These are briefly described in chapter 3.1.4. The development of these pipes has focused on the choice of materials. It has also been a development in different methods of how to weld the pipes together. New methods are already in use for PE-pipes and are offered from more and more pipe manufacturers.

3.1.3.3 The development of generator technology

The development of generators has been focused on large generators which can be used both in hydropower plants and wind turbines. These will reach the market after some time and will be available for mini and micro power plants. Currently, a generator with variable speed which is going to be used for large turbines and pump turbines is being developed. In Japan such a generator with 400MW is already running. The technology renders it possible for the turbine to run with varying speed so it can operate at the optimal efficiency over a larger span than it can today.

A generator which delivers a high voltage without the use of a transformer is also a technology that is under development. Such a generator could deliver directly to the high tension grid that exists in Norway. At the moment it is being tested, amongst others in Sweden.

Wind turbines have a demand for generators which can operate at a low and varying speed. ABB is currently developing one, and it has a large number of pole pairs and frequency converters built in so it can work well for wind turbines. This generator is called Windformer. A generator which operates at low speed will be useful for mini and micro turbines with a low head, when these operate at a relatively low speed.

3.1.3.4 The development of monitoring technology

Norwegian hydropower plants are continuously measuring effect, rotational speed, pressure, temperature, etc. which can yield a whole picture of the power plant's technical state. This measuring equipment has lately been made available at a reasonable price and the signals can be logged by an ordinary pc. This is technology which a clever power plant owner can operate himself, or one can by a commercial program which can monitor the power plant.

3.1.3.5 Remote control of the power plant

It exist well developed systems that can control a water turbine today. Lately technology has been made available which can transfer digital signals directly via the telephone network, and it is developed a technique to send these signals over the electrical grid. If one exploits these transmissions between a power plant and the pc at home or at the office, one could remote control and monitor a power plant from anywhere. The idea is that one can measure the effect, speed, pressure, temperature, etc. which yields a complete picture over the power plant's technical state. If protection and control routines are immediately stopped if something goes wrong, would those that have the remote control receive a message about the cause of the stop. If it is for example to little water in the intake (something which can happen in the summertime if it is dry) can the power plant start up again by using the remote control.

3.1.4 Analysis of resources in the lateral watercourses

This chapter describes how to execute surveys of the potential for mini and micro plants in a protected municipality.

The lateral watercourses of Gaula, in the SMART pilot region, is a resource that has been utilized (in different ways) from ancient times by the population. In 1953 it was as many as 43 working power plants in the area which today constitutes of the municipality of Midtre Gauldal. The first plants were already built in 1912. As the energy development expanded in the rest of the country, and transmission lines were built, the energy became available for more people and the local plants were closed down one by one. Only a few of the original plants are still running today. In retrospect, Gaula has become a protected river. There is a pressure on the agriculture today to reduce operating costs and to secure alternative sources of income, simultaneously as the energy situation in the country is strained. More and more licensees in the SMART pilot region are focusing on mini and micro power plants as an alternative source of income.

A survey of the potential can be performed with different degrees of accuracy. The survey of the municipality of Midtre Gauldal has been executed in two stages. In the first stage a rough estimation of the potential in the municipality is found fairly easy by using aids and assumptions which eases the process. The result from stage 1 determines if it is necessary to provide more resources to execute stage 2, where the potential is surveyed with a higher degree of accuracy.

The description of stage 1 which is a rough estimation of the potential is found in chapter 3.1.4.1. The description of stage 2 which is a more thorough survey of the potential is found in chapter 3.1.4.2.

Chapter 3.1.1 "Choice of turbine, pipes and valves" is a point by point guide which describes how a developer procures adequate information about the river/stream in question, to make an assessment of the projects technical and economical viability. This includes information about, amongst others, catchment area, head, effect, annual production, the selection of equipment for the power plant etc. Chapter 3.1.1 presents methods on how to find and calculate this information. Some of it will be described again in chapter 3.1.4. Due to this, chapter 3.1.4 uses a few references to chapter 3.1.1 in order to avoid twofold work that is difficult to follow.

Note that the NTNU SHP program tools, also described in deliverable D3.1, are based on the methodology described in chapter 3.1.1 and 3.1.4. The SHP program tools simplify the task of cost estimation by automatically performing the repetitive actions of cost estimation and generating the results.

3.1.4.1 Map based survey of lateral watercourses that are theoretically viable – stage 1

The aim of the map based survey is to gain an overview of the theoretically viable rivers/streams. In this map based survey is a M711- map from Topographic Main Map Series with a scale of 1:50.000.

In order to make the work load manageable is it important to establish some criteria. In this round, the criteria should not be too strict, to prevent the risk of excluding some projects that could have been theoretical/economical viable. Due to the fact that this project is a pilot, there exists a possibility that some of the criteria have to be altered. The municipality of Midtre Gauldal has in collaboration with The Norwegian Water Resources and Energy Directorate (NVE) produced the following criteria for the map based survey:

- $H/L > 0,03$ for small power plants.
- $H/L > 0,05$ for mini power plants.
- $H/L > 0,10$ for micro power plants.

Where H is the head and L is the horizontal length from the inlet of the penstock to the exit of the penstock.

- Projects where catchment areas are smaller than 2 km² are neglected.
- Projects where heads are smaller than 5 meters are neglected.
- The efficiency of a small power plant is set to 0,80 (Total efficiency).
- The efficiency of a mini power plant is set to 0,75 (Total efficiency).
- The efficiency of a micro power plant is set to 0,70 (Total efficiency).
- The distance to the nearest distribution network and the distance to the nearest road for micro power plants must be less than 1000m.
- The distance to the nearest distribution network and the distance to the nearest road for mini and small power plants must be less than 1500m.

The objective of this project is to find the maximal available effect for each relevant river/stream based on the theoretical and economical considerations. This is a prerequisite that especially affects the placement of the penstock and thereby the outlet and the head.

The procedure to find the parameters for a power plant is described in detail in chapter 3.1.1.

3.1.4.1.1 Restrictions for hydropower development in protected watercourses

In the early stages of a map based survey of the hydropower potential it is important to highlight the typical restrictions for the development of micro and mini power plants. At this stage in the survey there exist three obvious restrictions.

1. In this project the water power potential is only limited to watercourses that do not contain salmon and one must exclude the parts of the watercourse that does. When one disregard the main river in Gaula, does the following watercourses contain salmon in the municipality of Midtre Gauldal:
 - Sokna contain salmon.
 - Hauka contains salmon to Amdal.
 - Forda contains salmon to Høa.
 - Bua contains salmon to Storlimoen.
 - Herjåa contains salmon to the power plant at Hermo.
 - Ila and Stavilla contains salmon until about 150 meter upwards from the outlet of the watercourses.
 - Ena contains salmon until 50 meter upwards from the outlet of the watercourse.
2. Due to the fact that this is a protected watercourse, are the micro and mini power plants not able to use reservoirs, but only a smaller intake basin or other dams that may exist.
3. One must take into account the regulation of a watercourse, something that involves artificial watershed. In The municipality of Midtre Gauldal is Holtsjøen, Samsjøen and Burusjøen regulated, and Trønder Energy is the licensee. This involves that the run-off area to Holta and Buru is reduced with artificial watersheds.

3.1.4.1.2 Estimation method

From the M711-map with a scale of 1:50.000 are the catchments areas determined [km²]. The catchments areas exist of a number of a number of squares and one can find the approximate size of each area by counting. One square is 1 km², which implies if only one half of a square is situated in the catchment area in question, it corresponds to an addition to the area of 0,5 km².

The averaged annual run-off [l/s km²] is found from NVE's isohydat map. For the municipality of Midtre Gauldal is a run-off map over Norway: "Avrenningskart over Norge" sheet 4 applied. The Isohydat Map has a scale of 1:500.000, i.e. the catchment area must be scaled from the M711 map to the isohydat map. The values of the annual averaged run-off from the isohydat map can be somewhat inaccurate due to the large difference in the scales of the two map classes. The procedure to estimate the annual averaged run-off [l/s km²] and the annual averaged flow capacity [m³/s] corresponds to the procedure described in chapter 3.1.1.

For stage 1 it is assumed that the turbine utilizes 30% of the annual averaged flow capacity. However, the exact utilization factor is precisely estimated in stage 2 of the process by the use of duration curves.

At this level in the survey of the potential one can find the head from the M711 map.



Based on the parameters described above in addition to the criteria for the map survey, is this adequate information to estimate the effect of a micro and mini power plant. The procedure to estimate the effect is described in chapter 3.1.1.

The result of stage 1 is a number of theoretically available projects who proved that it is recommended to continue with the computations in stage 2.

3.1.4.2 Computing the theoretical/economical available potential considering mini and micro power plants – stage 2

The result of stage 1 which is described in chapter 3.1.4.1 is a list of theoretical available micro and mini power plants based on simplified calculations. The computation for stage 2 is based on this list. Stage 2 will result in a list which will probably contain a smaller number of projects than the starting point.

Stage 2 is based on more exact values of catchment areas, annual averaged run-off, annual averaged flow capacity, flow rate which the power plant is designed for, head, penstock length etc.

3.1.4.2.1 Head

The big challenge in the computation of the theoretical/economical potential is to find the location of the inlet for the penstock and the power plant. With hard rock as the foundation in the river bed is it formed waterfalls, otherwise does the river/stream cut down into the river bed and it is created V-shaped valleys, or with other words a smaller pressure gradient. It is favourable economically for a power plant in respect to penstock costs with waterfalls, because it yields a high pressure gradient. The price of a penstock is for many power plant developers a deciding factor in evaluating the economical viability of the project, and hence to realize the project. The price depends mainly on the length and the type of pipe. The pipe length is a result of the topography in the terrain and the type of pipe depends in turn on the flow rate and pressure class. A larger power plant can usually answer for a more expensive penstock than a smaller one. In other words, there are many parameters that affect the placement of the pipe. To recapitulate these parameters into a method where one can place a penstock by simply looking at the map is not easy. In this project were the factor H/L and the pressure gradient used to make a rough estimation of the placement. The economical consideration decides where the penstock will be situated. The pressure gradients that are used are those that are listed in chapter 3.1.4.1. These are suggested by The Norwegian University of Technology and Science (NTNU) and accepted by NVE and the municipality of Midtre Gauldal. This kind of pressure gradient is probably used for the first time in this project. It is important to make a note of that it is probable with more than one solution to this problem, and that maybe this solution should be corrected in later use.

In order to find a good estimate for the head for each of the micro and mini power plants was Economic map used with a scale of 1:5.000 which corresponds to contour lines for each fifth height meter. A map from the M711 series with a scale of 1:50.000 and contour lines for each twentieth height meter is to crude to use in this connection. It is described additional methods to find the head in chapter 3.1.1, but not everyone was suitable to use in this instance, because this is a map survey.

3.1.4.2.2 Catchment area

When the exact head at the highest and lowest contour line is registered, it remains to planimeter the catchment area on the M711 map. Meanwhile, it is important to note that the unit of area on the planimeter, in this case, should be [m²] and not [km²]. With the unit [km²] it can be hard to find the correct area for a catchment area. The planimeter is a sensitive

instrument which can result in large fluctuations if the foundation is askew. Maps are usually folded and will therefore have dents, something that brings along an uncertainty in the reading. It is therefore wise to crosscheck the values from the planimentation with values from counting squares. The planimeter itself guarantees an accuracy of $\pm 0.2\%$.

3.1.4.2.3 Averaged flow capacity

In this chapter the same method is used for finding the averaged run-off and the averaged flow capacity as in chapter 3.1.4.1. The values are of course updated in accordance to the size of the catchment area.

3.1.4.2.4 Service life and duration curve

From duration curves one can find the service life of an installation. To interpolate the data from the metering stations of every possible power plant may involve a great deal of work. Therefore the municipality of Midtre Gauldal contacted the hydrologist John Tveit, 1 assistant professor at hydraulic construction department (Vassbygg) at NTNU. He has composed a note to aid the exploration of the potential for small power plants in the municipality of Midtre Gauldal. The duration curve is developed on the basis of a model of a power plant with a Francis turbine and one model with a Pelton turbine. In some of these power plants it should have been used a Kaplan turbine since it is a small head and a large flow rate. To find the duration curve for rivers/streams it was made an assumption of installing a Francis turbine, but this has only been done to produce duration curves. Figure 3.1.4.1 illustrates roughly the area of application for Francis and Pelton turbines. The area of application for Pelton is over the thick blue line, while for Francis it is below the line.

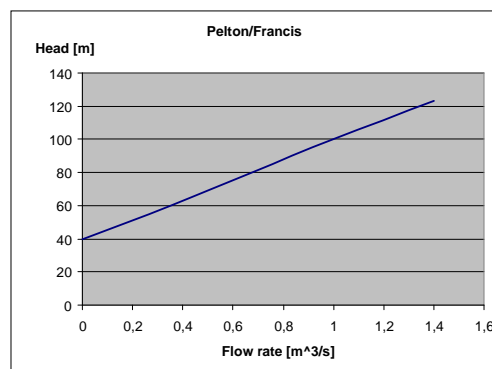

Figure 3.1.4. 1: Area of application for Pelton and Francis turbines.

3.1.4.2.5 Effect, energy production, pipe diameter, and design pressure for pipes.

The calculation methods for effect, energy production, pipe diameter and design pressure for pipe and pipe length that is presented in chapter 3.1.1, is in accordance with the procedure of the survey of the potential in the SMART pilot region.

The results from this survey are presented in the deliverable D4.1 of the SMART project.

3.1.4.2.6 The costs of building and construction

This expense foundation is developed by NVE and the project has access to apply this to the expense calculations for micro and mini power plants. These are prices for January 2000. In the SHP software tools developed at NTNU, presented later in this report, it is easy to enter the price increase (due to f.ex. inflation) in order to update the values from year 2000.

The input data for the cost functions are the flow, head, soil type, turbine type, the voltage connection and the length of the pipeline, of the road and of the power line. These functions

are valid for SHPP with flow values less than $10\text{m}^3/\text{s}$. These costs include labour and mounting costs of all the equipment.

Since NVE has produced the foundation for the calculation of costs for these power plants, are some of the following text “borrowed” from the NVE report, ” Kostnadsgrunnlag for mindre vannkraftanlegg (50-5000 kW)”.

3.1.4.2.6.1 The expense foundation for the building of an intake dam

For the power plants which the expenses are calculated for the SMART pilot region, it is without exception plants with a single intake where it is not possible to have a water reservoir. Due to this, it will only be estimated expenses for an intake dam in this report.

An intake includes an intake basin, an intake trash rack and a shutting mechanism. The basin/intake construction should be designed in the manner that it would not become a problem with ice freeze-up, floating rubbish in the water surface and the sediment transport should be kept at a minimum. In these instances this can be diverted from the intake, simultaneously as one attempt to ensure good inflow conditions. Typically, the intake should be at a minimum 2 meters below the water surface. A small basin can be built by means of digging/blasting to lower the river bottom or to construct a dam. The cost for screen, hatchways, gate cleaner etc. is not included in the construction costs, but is included later. On the other hand are costs for intake cone and a simple super structure included.



Figure 3.1.4. 2: Intake dam at Glisja power plant in the municipality of Midtre Gauldal

Large costs are divided into three classes for this type of intake basin. These are:

1. Flow rates through the power plant less than $0,15\text{ m}^3/\text{s}$.
2. Flow rates through the power plant between $0,15\text{ m}^3/\text{s}$ and $1\text{ m}^3/\text{s}$.
3. Flow rates through the power plant between $1\text{ m}^3/\text{s}$ and $10\text{ m}^3/\text{s}$.

For a flow rate that is less than 0,15 m³/s will the price of the intake basin set to be constant at NOK 35.000,-. NVE has illustrated in figure 3.1.4.3 how large the costs are for classes 2 and 3.

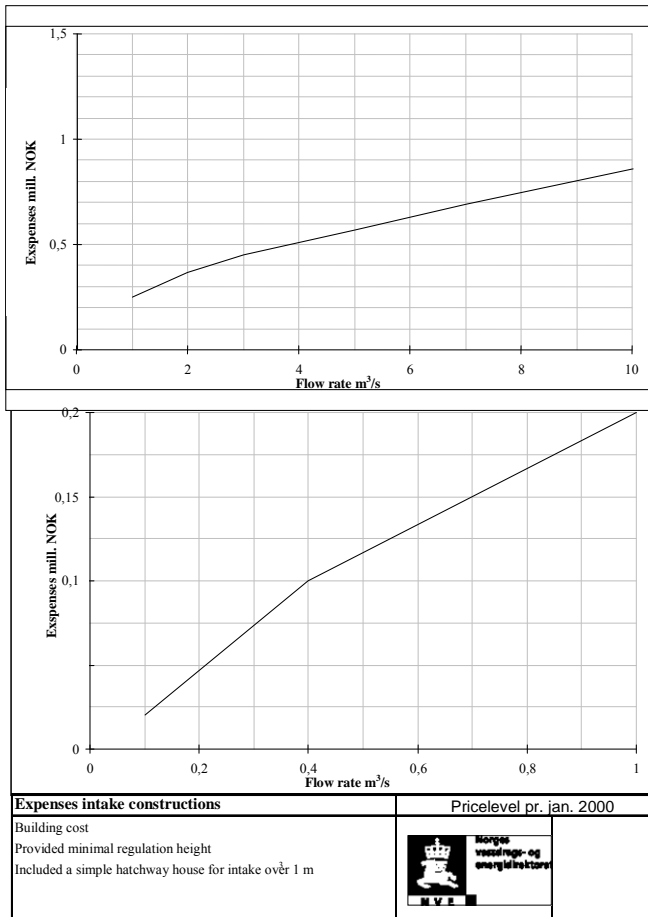

Figure 3.1.4.3: Expenses of an intake basin with a flow rate from 0,1 to 10 m³/s

The cost of an intake basin for flow rates between 0,1 m³/s and 1 m³/s are calculated in accordance with equation 3.1.1.

$$K_D = -0,1111 \cdot Q^2 + 0,3222 \cdot Q - 0,0111 \quad [\text{mill. NOK.}] \quad [3.1.1]$$

Where:

$$\begin{aligned}
 K_D &= \text{Cost of an intake basin} && [\text{mill. NOK.}] \\
 Q &= \text{Flow rate} && [\text{m}^3/\text{s}]
 \end{aligned}$$

The cost of an intake basin for flow rates between 1 m³/s and 10 m³/s are calculated in accordance with equation 3.1.2.

$$K_D = -0,00001 \cdot Q^3 - 0,0012 \cdot Q^2 + 0,0772 \cdot Q + 0,2049 \quad [\text{mill. NOK.}] \quad [3.1.2]$$

3.1.4.2.6.2 The expenses of the construction of a power station

Power stations vary in size and complexity according to how large flow rate and effect the power plants have. In this report it is only calculated expenses for a power plant that is built outdoors and not inside a mountain. At this point one finds the area of the water plant were the developer can contribute with substantial efforts in keeping the costs low. The costs will therefore vary from power plant to power plant. The costs of such power plants are shown in figure 3.1.4.4. Where it is displayed three curves based on the collected costs for similar power stations in Norway. In this report will the costs be calculated according to the solid line in figure 3.1.4.4. The remaining two curves represent the variation in the collected costs.

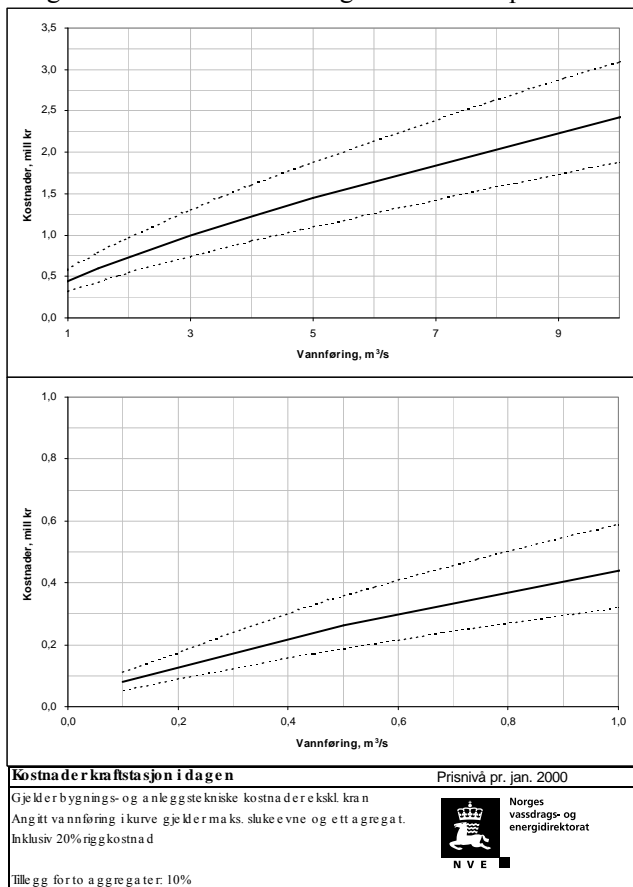

Figure 3.1.4.4: Costs of a power station with a flow rate from 0,1 to 10 m³/s.

The cost of a power station with a flow rate between 0,1 m³/s and 10 m³/s is calculated in accordance with equation 3.1.3.

$$K_{Kr} = 0,44 \cdot Q^{0.74} \quad [\text{mill. NOK.}] \quad [3.1.3]$$

Where:

$$K_{\text{NOK}} = \text{Cost of a power station} \quad [\text{mill. NOK.}]$$

$$Q = \text{Flow rate} \quad [\text{m}^3/\text{s}]$$

3.1.4.2.6.3 The cost of the construction of a penstock

When laying pipes from the intake basin to the power station, one have to lay these in a penstock that has the necessary anchorage and support configurations in order to always keep the penstock in place. In this report are external and buried penstocks described. The costs are calculated for a moderate drop and good soil conditions.

Possible pipe types are spirally welded steel pipes, glass-fibre armed unsaturated polyester pipes (GUP), polyethylene pipes (PE), concrete pipes, ductile cast-iron pipes and wooden pipes. Laying the foundations for pipes can either be done by burying them or on foundation blocks. The different types of pipes have different demands to the foundation, due to among other factors the type of material, jointing method and how the forces are conveyed. The usual combinations are displayed in the table below.

Type of pipe	Buried	On foundation
Steel pipe		X
GUP-pipe	X	X
PE-pipe	(X)	
Concrete pipe	X	
Ductile cast-iron pipe	X	X
Wooden pipe		X

External pipeline

The design of the pipe foundation will vary between the types of pipes, but here an averaged cost is used for the calculations. The design of the foundation is found in the supplier's installation instructions or assistance can be given from experienced consultants/developers.

The calculated costs of construction costs and building costs for penstocks in this report include the following assumptions for the foundation of an external penstock:

Clearing the line	20 NOK/m ²
Excavation	60 NOK/m ³
Blasting	200 NOK/m ³
Concrete formwork	650 NOK/m ²
Reinforcement	10 NOK/kg
Concrete	1.500 NOK/m ³
Rig expenses	20 %

Concerning the costs for clearing, excavation, blasting, concrete formwork, reinforcement and the volume of the concrete will they be very different for the various power plants. If PE-pipes are used with a diameter less than 0,4 m could this cost become minimal, when these are placed directly on the ground without anchorage nor support. This is not a recommended method due to the reason that this can lead to a large load on the pipe where the ground does not yield the required support.

It is assumed a distance of 9 meters between the foundations and 60 meter between the anchor blocks.

The costs for an external pipeline are calculated in accordance with equation 3.1.4 and illustrated by figure 3.1.4.5.

$$K_{\text{pipeline}} = 212 \cdot D_R^2 + 880 \cdot D_R + 333 \quad [\text{NOK}/\text{consecutive meter pipe}] \quad [3.1.4]$$

where

K_{pipeline} = Cost of pipeline per consecutive meter pipe [NOK]
 D_R = Pipe diameter [m]

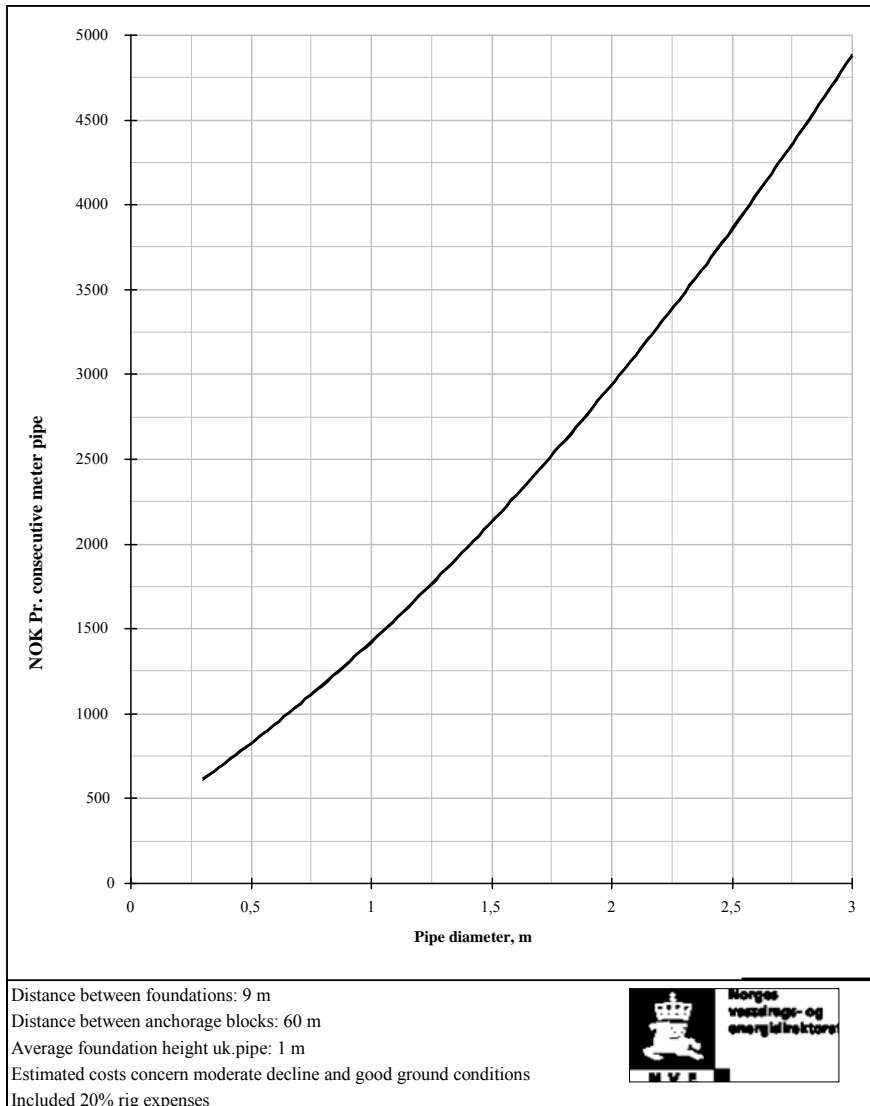

Figure 3.1.4.5: The costs of foundation for an external penstock

Pipe trenches

For application in the calculations of the cost for buried pipes it is developed cost curves for earth trenches, rock trenches and combined earth/rock trenches.

For buried pipes are the most suitable pipes concrete pipes, cast-iron pipes and GUP-pipes. Polyethylene pipes can also be suitable, but then with low pressures and in mild terrain.

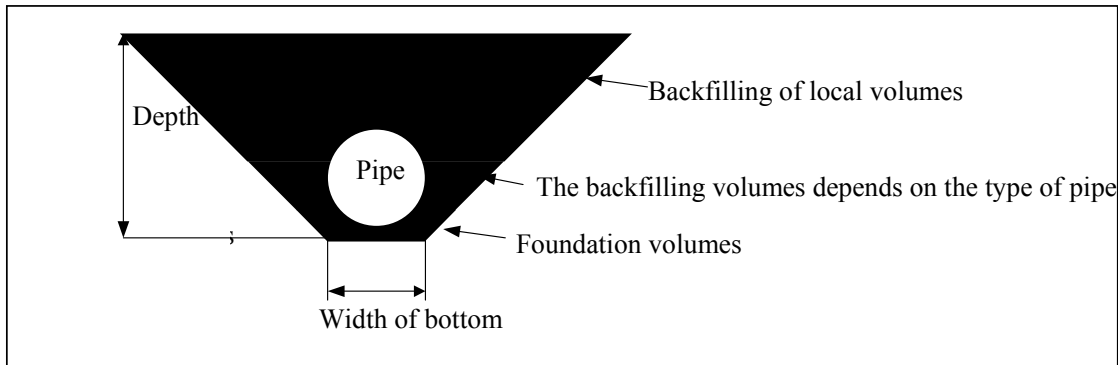

FIGURE 3.1.4.6: TYPICAL CROSS-SECTION FOR A BURIED PIPE

The costs include all costs for digging, blasting, and backfilling from 30 cm over the pipe. The backfilling around the pipe is calculated separately as an addition with a unit price of 150-200 NOK/m³ backfilling mass.

The slope of the trench is set to be 1:1 for earth trenches and 5:1 for rock trenches as shown in figure 3.1.4.7 and 3.1.4.8.

The following unit prices are the basis for the trench expenses.

Digging	65	NOK/m ³
Blasting	200	NOK/m ³
Rig expenses	20	%

For the costs that are calculated in this report it is assumed that the volume placed in the pipe trenches has the dimension as in figure 3.1.4.7 and 3.1.4.8. The depth is assumed to be 2 meters if the diameter of the pipe is less than 1 meter. If the pipe diameter is larger than 1 meter is the depth assumed to be 3 meters.

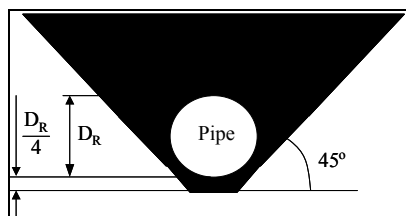

Figure 3.1.4.7: Pipe trench in earth

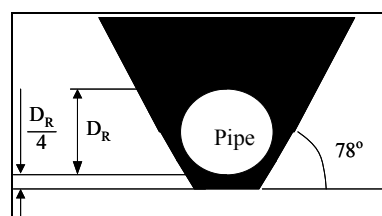

Figure 3.1.4.8: Pipe trench in rock

The costs for a pipe trench with a width of bottom of 1 meter (see figure 3.1.4.5), placed in earth and rock is calculated in accordance with equations 5 and 6 and as shown in figure 3.1.4.9.

$$KJ_{\text{pipetrench}} = 48 \cdot \text{Depth}^2 + 240 \cdot \text{Depth} \quad [\text{NOK}/\text{consecutive meter}] \quad [3.1.5]$$

$$KF_{\text{pipetrench}} = 78 \cdot \text{Depth}^2 + 78 \cdot \text{Depth} \quad [\text{NOK}/\text{consecutive meter}] \quad [3.1.6]$$

where

$KJ_{\text{pipetrench}}$ = Cost of pipe trench in earth per consecutive meter pipe [NOK]

$KF_{\text{pipetrench}}$ = Cost of pipe trench in rock per consecutive meter pipe [NOK]

Depth = Depth of pipe trench, see Figure 3.1.4.5 [m]

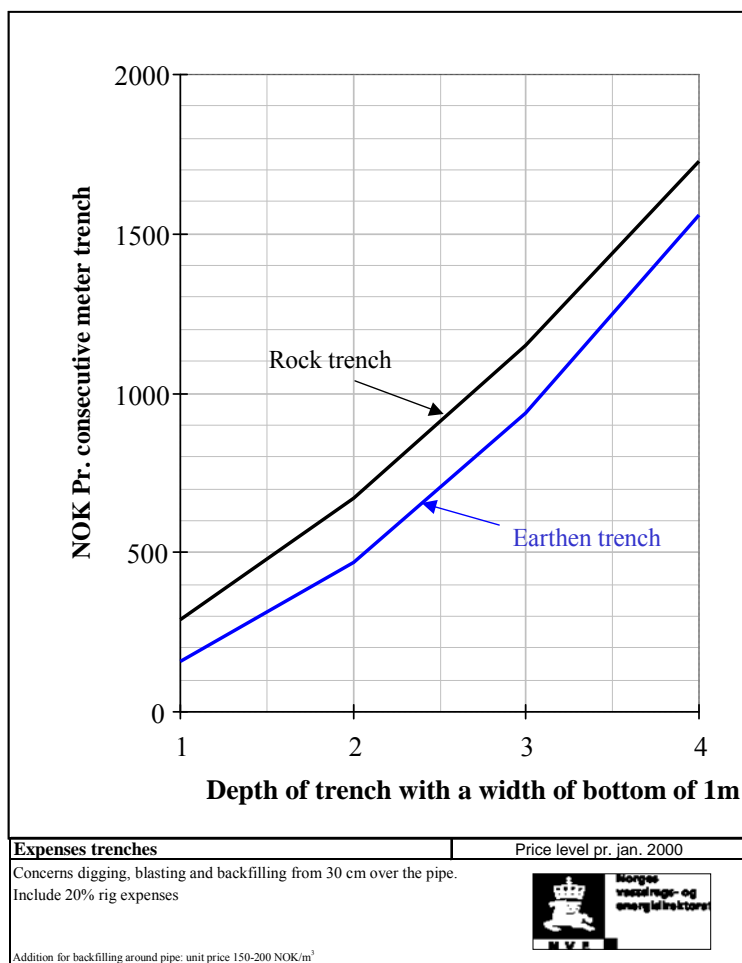

Figure 3.1.4. 9:.. Costs of pipe trench width of bottom of 1 meter

The expenses for a pipe trench with a width of bottom of 2 meters (see Figure 3.1.4.5), placed in earth and rock are given by equations 7 and 8 and illustrated in figure 3.1.4.10.

$$KJ_{\text{pipetrench}} = 48 \cdot \text{Depth}^2 + 480 \cdot \text{Depth} \quad [\text{NOK}/\text{consecutive meter}] \quad [3.1.7]$$

$$KF_{\text{pipetrench}} = 78 \cdot \text{Depth}^2 + 156 \cdot \text{Depth} \quad [\text{NOK}/\text{consecutive meter}] \quad [3.1.8]$$

where

$KJ_{\text{pipetrench}}$ = Cost of pipe trench in earth per consecutive meter pipe [NOK/consecutive meter]

$KF_{\text{rorgrøft}}$ = Cost of pipe trench in rock per consecutive meter pipe [NOK/consecutive meter]

Depth = Depth of pipe trench, see Figure 3.1.4.5 [m]

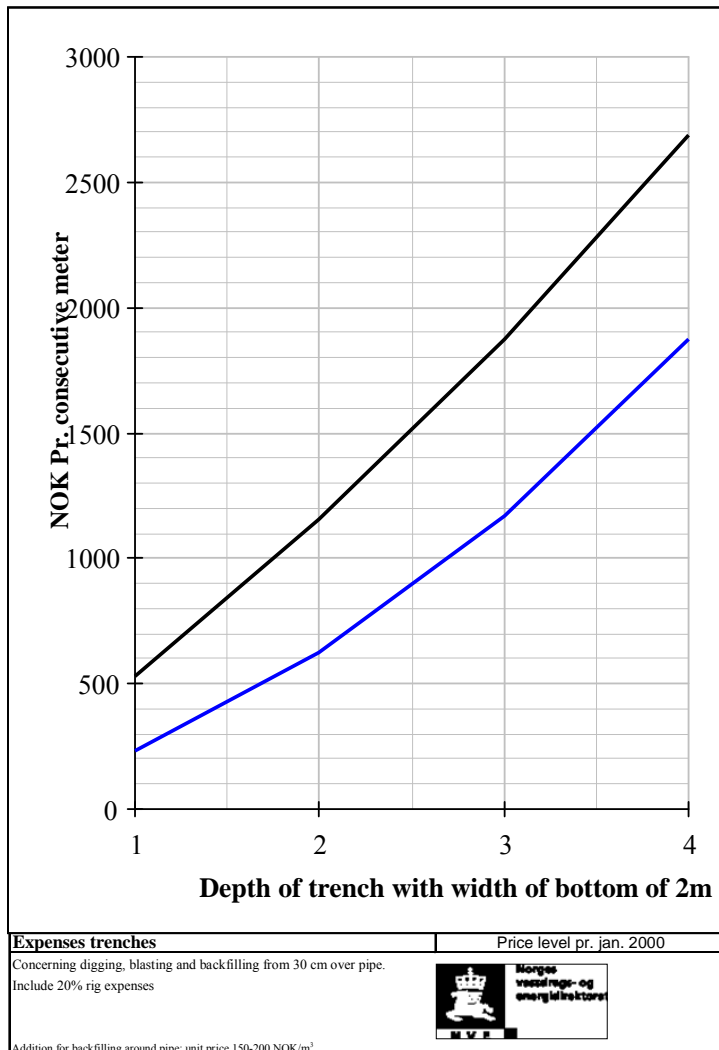

Figure 3.1.4. 10: Expenses for pipe trench with a width of bottom of 2 meter

3.1.4.2.6.4 The expenses for building a temporary road for construction purposes

As a foundation for the calculation of expenses for the building of a temporary road for construction purposes, is it in addition to experience number from hydropower plants also used experience numbers from forestry. The expenses will naturally vary a lot with the topography and the availability of volumes, in addition to the standard of the temporary road. NVE has presupposed that the built road holds a standard equal to a forest road class 3. The expenses include a finished built road with planning, staking out, digging, blasting, culverts, surface base and gravelling. The size of the different parts, as for example blasting and delivery of volumes, will have a large impact on the price.

The expenses of finished built temporary road for construction purposes:

- Temporary road in mild terrain 200 NOK/consecutive meter of road
- Temporary road in moderate terrain 500 NOK/consecutive meter of road
- Temporary road in hard terrain 800 NOK/consecutive meter of road

In this report it assumed moderate terrain. The cost of maintenance of the temporary road in the construction period is expected to be about 10% of the temporary road expenses.

For smaller and simpler bridges are the expenses about 2000 NOK/m² roadway (bridge surface).

3.1.4.2.6.5 Construction costs which are not included in this report.

For some costs it does not exist any adequate experience numbers, therefore will they not be entered into the post "miscellaneous". Examples of these are given in the following:

- Transport
- Unforeseen costs
- Value added and investment tax
- Contractor costs
 - Measuring
 - Ground assessments
 - Planning
 - Administration, construction management, quality control
 - Rehabilitation, clearing
 - Land acquisition, assessment, compensation
 - Financial tax

3.1.4.2.7 Costs of mechanical works

The cost basis is developed by NVE and this project is permitted make use of it in the calculations of the costs of micro and mini power plants. The basis is found in the NVE report, "Kostnadsgrunnlag for mindre vannkraftanlegg (50-5000 kW)", and the price level is January 2000. In the financial analysis of nine rivers in Holtålen, presented in deliverable D4.1, these cost functions are updated with a price increase corresponding to inflation etc.

The mechanical works includes hatches, pipes, valves, turbine and turbine regulation for turbines with an effect over 500kW. For turbines with an effect less than 500kW will the generator, control installation, switch gear and if necessary a transformer is included in the price.

On the other hand will the delivery not include:

- Construction costs
- Transport
- Spare parts
- Value added tax
- Investment tax
- Contractor costs
- Unforeseen

The cost basis is developed from prices of plants that are built in the period 1995 – 2000.

3.1.4.2.7.1 The costs of turbine

For the calculation of the costs, it is presupposed that a Pelton, Francis or Kaplan turbine is used in the power plants. These turbine types are selected on different grounds for small, mini and micro power plants. The difference in the selection is demonstrated in figure 3.1.4.11 and 3.1.4.12.

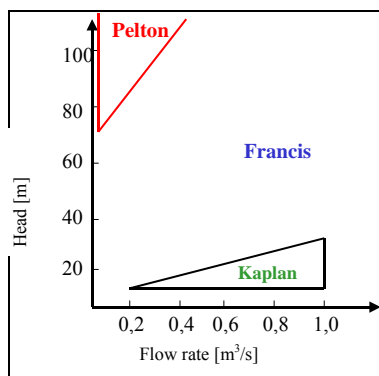

Figure 3.1.4. 12: Choice of turbine type for micro- and mini power plants

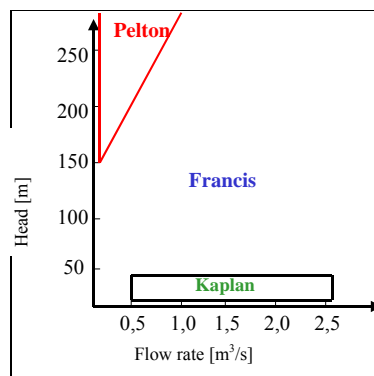

Figure 3.1.4. 11: Choice of turbine type for small power plants

In the computations for the selection of turbine is it used a specific velocity number as the criteria for the choice of turbine. The speed number is defined in equation 3.1.9.

$$\underline{\Omega} = \underline{n} \cdot \sqrt{\underline{Q}} \quad [-] \quad [3.1.9]$$

where

$$\begin{aligned} \underline{Q} &= \text{Specific speed} & [-] \\ \underline{Q} &= \text{Specific flow rate} & [-] \\ \underline{n} &= \text{Specific rotational speed} & [-] \end{aligned}$$

In this report it is assumed a rotational speed of 750 rpm if the head is less than 35 meter and 1500rpm if the head is higher than 35 meter.

The criteria for small turbines (effect from 1 to 10MW) are:

$$\begin{aligned} 0 < \underline{\Omega} \leq 0,19 & \quad \text{Pelton} \\ 0,19 < \underline{\Omega} \leq 1,5 & \quad \text{Francis} \\ 1,5 < \underline{\Omega} & \quad \text{Kaplan} \end{aligned}$$

The criteria for micro and mini turbines (effect from 0 to 1000 kW) are:

$$\begin{aligned} 0 < \underline{\Omega} \leq 0,15 & \quad \text{Pelton} \\ 0,15 < \underline{\Omega} \leq 1,5 & \quad \text{Francis} \\ 1,5 < \underline{\Omega} & \quad \text{Kaplan} \end{aligned}$$

Pelton turbines with an effect from 50 kW to 500 kW

As a basis of the costs for Pelton turbines, NVE has developed a computation basis for 80, 125, 200 and 250 meter head. This is equations 10, 11, 12 and 13. For the cost calculations in this report are these equations valid for turbines down to 5 kW.

$$K_{\text{turbine}} = 4907 \cdot Q^2 - 5418 \cdot Q + 6098 \quad [\text{NOK/kW}](\text{Pelton, 80m head}) \quad [3.1.10]$$

$$K_{\text{turbine}} = 2984 \cdot Q^2 - 4490 \cdot Q + 5232 \quad [\text{NOK/kW}](\text{Pelton, 150m head}) \quad [3.1.11]$$

$$K_{\text{turbine}} = 3815 \cdot Q^2 - 5892 \cdot Q + 4568 \quad [\text{NOK/kW}](\text{Pelton, 200m head}) \quad [3.1.12]$$

$$K_{\text{turbine}} = 2000,4 \cdot Q^{-0,2027} \quad [\text{NOK/kW}](\text{Pelton, 250m head}) \quad [3.1.13]$$

where

$$\begin{aligned} K_{\text{turbine}} &= \text{Cost of turbine} & [\text{NOK/kW}] \\ Q &= \text{Flow rate} & [\text{m}^3/\text{s}] \end{aligned}$$

These prices include turbine, turbine regulation, inlet valve, generator, control installation, switch gear and if necessary a transformer. The resulting curves are shown in figure 3.1.4.13. To obtain a reasonable price for the actual price of one plant, has it been performed a linear

interpolation of equations 10, 11, 12 and 13. If the head is below 80 meter is equation 3.1.10 used, and if the head is over 250 meter is equation 3.1.13 used.

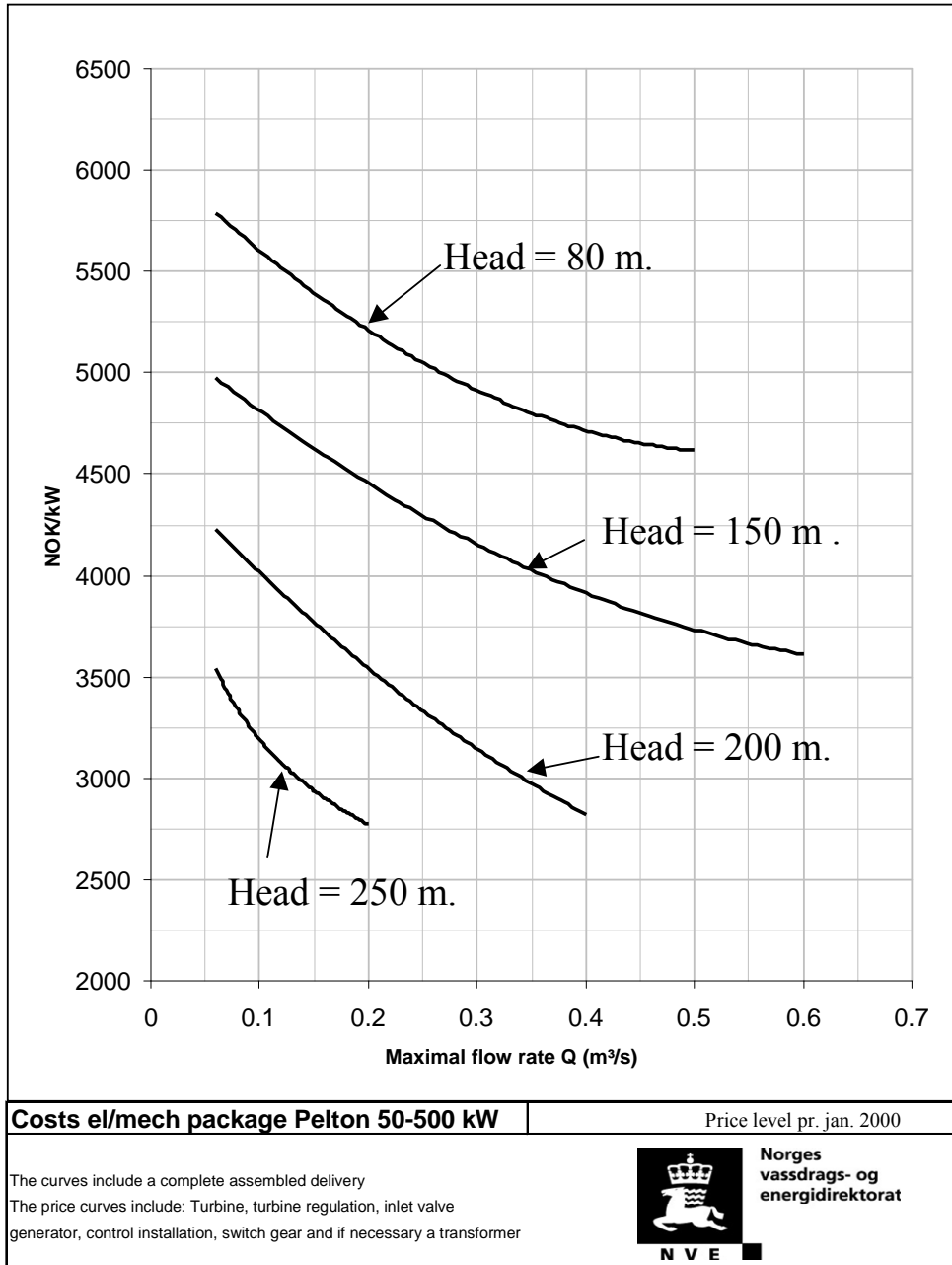

Figure 3.1.4. 13: The cost basis for Pelton turbines with an effect between 50 and 500 kW

Pelton turbines with an effect from 500 kW to 5000 kW

As a basis for the costs of Pelton turbines, NVE has developed a computation basis for 150, 250 and 600 meter head. This is equations 3.14, 15, 16 and 17.

$$K_{\text{turbine}} = 1748,8 \cdot Q^{-0,378} \quad [\text{NOK/kW}](\text{Pelton, 150m head}) \quad [3.1.14]$$

$$K_{\text{turbine}} = 1365,8 \cdot Q^{-0,4406} \quad [\text{NOK/kW}](\text{Pelton, 250m head}) \quad [3.1.15]$$

$$K_{\text{turbine}} = 1019,7 \cdot Q^{-0,5075} \quad [\text{NOK/kW}](\text{Pelton, 400m head}) \quad [3.1.16]$$

$$K_{\text{turbine}} = 867,5 \cdot Q^{-0,492} \quad [\text{NOK/kW}](\text{Pelton, 600m head}) \quad [3.1.17]$$

where

$$\begin{array}{lll} K_{\text{turbine}} & = & \text{Cost of turbine} \quad [\text{NOK/kW}] \\ Q & = & \text{Flow rate} \quad [\text{m}^3/\text{s}] \end{array}$$

These prices include turbine, turbine regulation and inlet valve. The resulting curves are shown in figure 3.1.4.14. To obtain a reasonable price for the actual price of one plant has it been performed a linear interpolation of equations 14, 15, 16 and 17. If the head is below 150 meter is equation 3.1.14 used, and if the head is over 600 meter is equation 3.1.17 used.

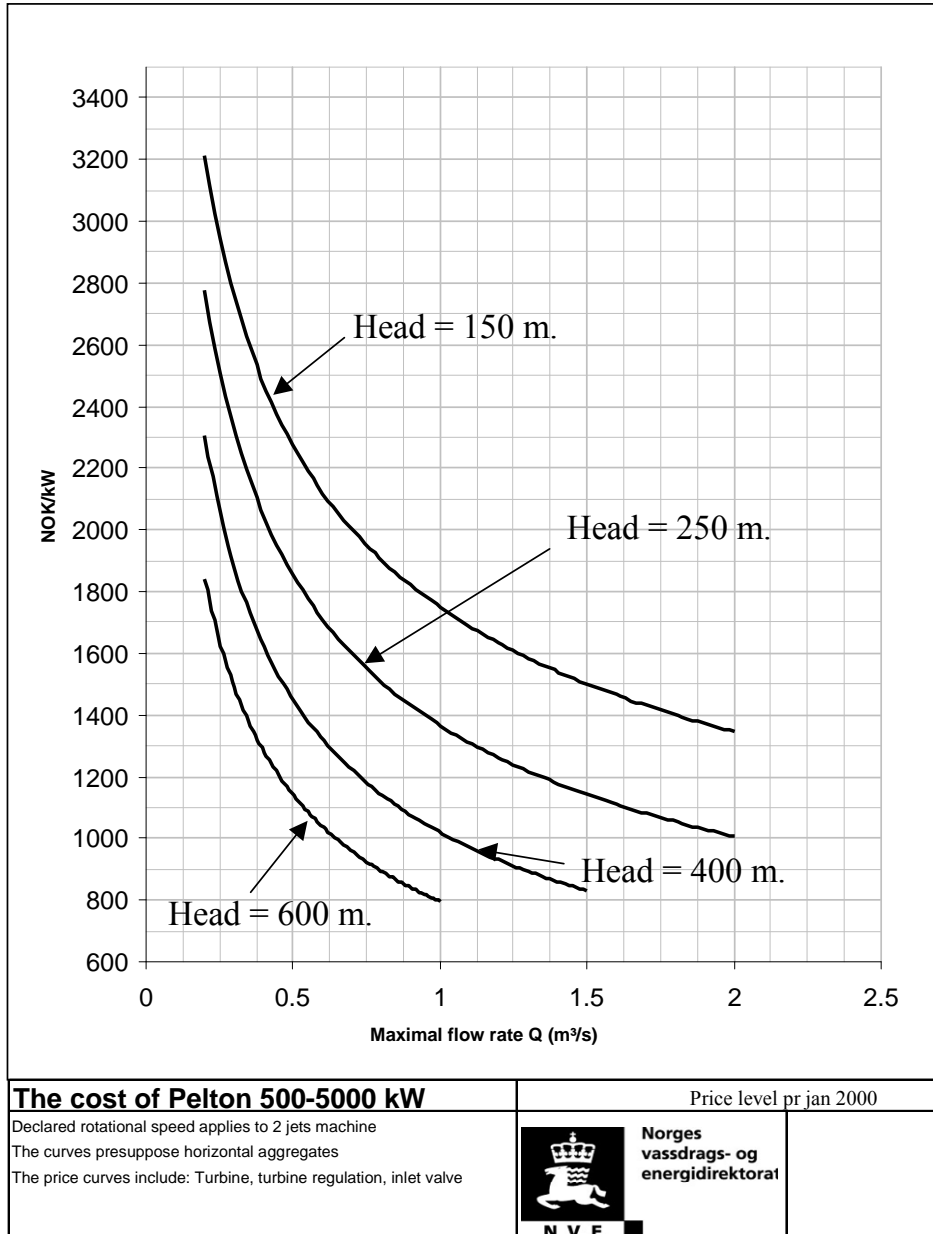

Figure 3.1.4. 14: The cost basis for Pelton turbines with an effect between 500 and 5000

kW

Francis turbines with an effect from 50 kW to 500 kW

As a basis of the costs of Francis turbines, NVE has developed a computation basis for 30, 160, 100 and 130 meter head. This is equations 3.1.18, 19, 20 and 21. For the cost calculations in this report, are these equations valid for turbines down to 5 kW.

$$K_{turbine} = 4358 \cdot Q^{-0,2279} \quad [\text{NOK/kW}] \text{ (Francis, 30m head)} \quad [3.1.18]$$

$$K_{turbine} = 3606 \cdot Q^{-0,2988} \quad [\text{NOK/kW}] \text{ (Francis, 60m head)} \quad [3.1.19]$$

$$K_{turbine} = 3057 \cdot Q^{-0,3575} \quad [\text{NOK/kW}] \text{ (Francis, 100m head)} \quad [3.1.20]$$

$$K_{turbine} = 2490 \cdot Q^{-0,4362} \quad [\text{NOK/kW}] \text{ (Francis, 130m head)} \quad [3.1.21]$$

where:

$$\begin{array}{ll} K_{turbine} & = \text{Cost of turbine} \quad [\text{NOK/kW}] \\ Q & = \text{Flow rate} \quad [\text{m}^3/\text{s}] \end{array}$$

These prices include turbine, regulation of turbine, inlet valve, generator, control installation, switch gear and if necessary a transformer. The resulting curves are shown in figure 3.1.4.15. To obtain a reasonable price for the price of one plant has it been performed a linear interpolation of equations 18, 19, 20 and 21. If the head is less than 30 meters is equation 3.1.18 used, and if the head is over 130 meters is equation 3.1.21 used.

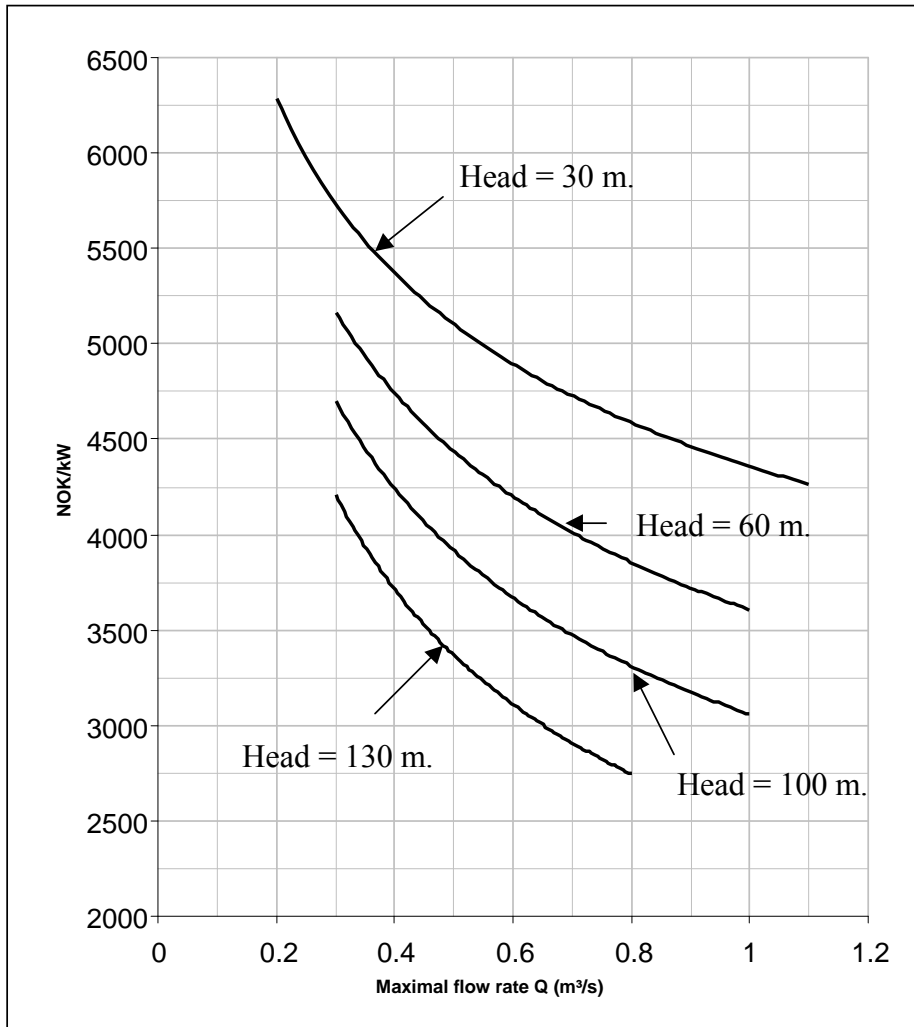

The cost of el/mech package Francis 50-500 kW Price level pr. jan. 2000

The curves presuppose horizontal aggregat with turbine center
 2-3 meter over lowest tailwater when fully loaded
 The prices include complete assembled delivery
 The price curves include: Turbine, turbine regulation, inlet valve
 generator, control installation, switch gear and if necessary a transformer

Figure 3.1.4. 15: The cost basis for Francis turbines with an effect between 50 and 500 kW

Francis turbines with an effect from 500 kW to 5000 kW

As a basis of the costs of Francis turbines has NVE developed a computation basis for 30, 60, 100 and 200 meter head. This is equations 3.1. 22, 23, 24, 25 and 26.

$$K_{turbine} = -512 \cdot \ln Q + 2891 \quad [\text{NOK/kW}] \quad (\text{Francis, 30m head}) \quad [3.1.22]$$

$$K_{turbine} = -354 \cdot \ln Q + 2138 \quad [\text{NOK/kW}] \quad (\text{Francis, 60m head}) \quad [3.1.23]$$

$$K_{turbine} = -304 \cdot \ln Q + 1819 \quad [\text{NOK/kW}] \quad (\text{Francis, 80m head}) \quad [3.1.24]$$

$$K_{turbine} = -300 \cdot \ln Q + 1644 \quad [\text{NOK/kW}] \quad (\text{Francis, 100m head}) \quad [3.1.25]$$

$$K_{turbine} = -217 \cdot \ln Q + 1308 \quad [\text{NOK/kW}] \quad (\text{Francis, 200m head}) \quad [3.1.26]$$

where:

$$\begin{array}{lll} K_{turbine} & = & \text{Cost of turbine} \quad [\text{NOK/kW}] \\ Q & = & \text{Flow rate} \quad [\text{m}^3/\text{s}] \end{array}$$

These prices include turbine, turbine regulation and inlet valve. The resulting curves are shown in figure 3.1.4.16. To obtain a reasonable price of the price of one plant has it been performed a linear interpolation of equations 3.1.22, 23, 24, 25 and 26. If the head is less than 30 meters is equation 3.1.22 used, and if the head is higher than 200 meters is equation 3.1.26 used.

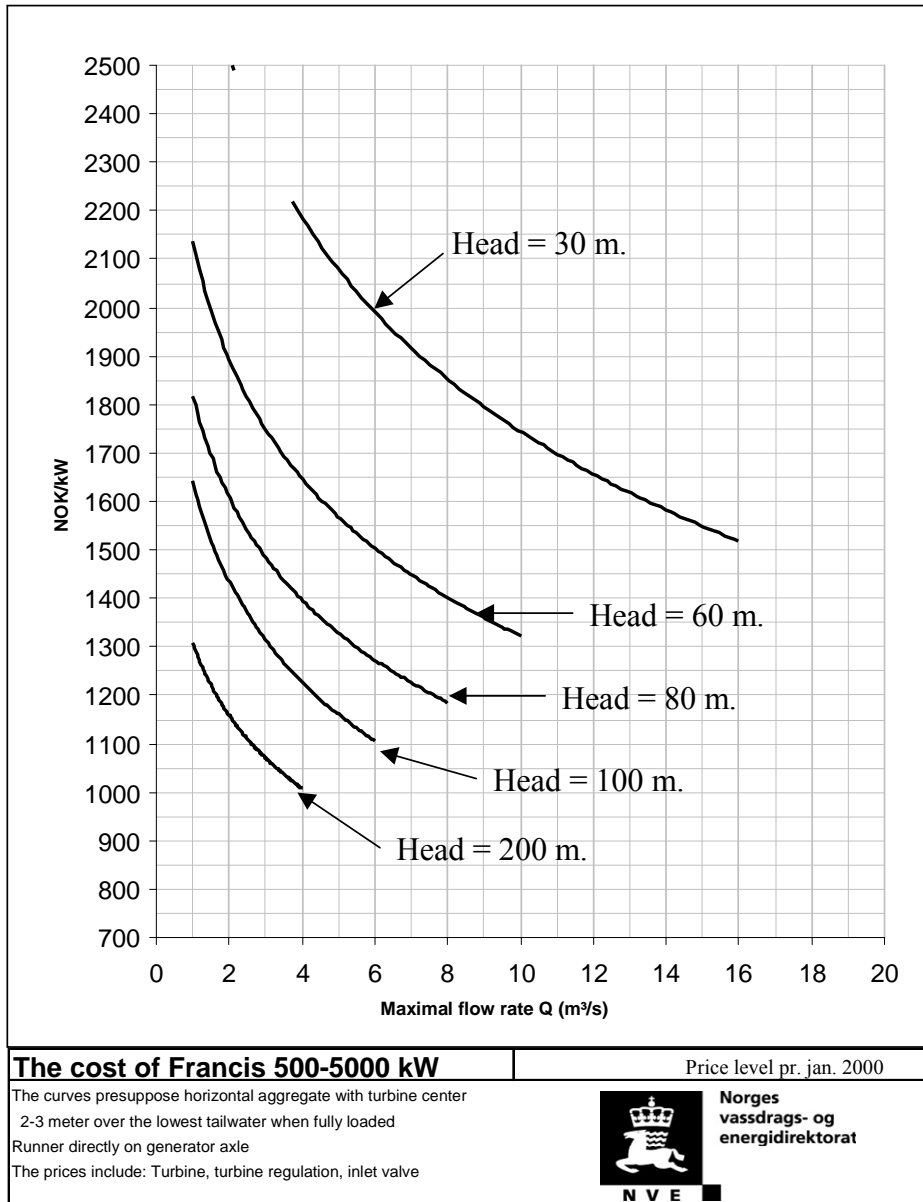

Figure 3.1.4.16: The cost basis of Francis turbines with an effect between 500 and 5000 kW

Kaplan turbines with an effect from 50 kW to 500 kW

As a basis of the costs of Kaplan turbines has NVE developed a computation foundation for 5, 10 and 20 meter head. This is equations 3.1.28, 28 and 29. In the calculations of the costs in this report, are these equations valid down to 5 kW.

$$K_{turbine} = 10272 \cdot Q^{-0,2154} \quad [\text{NOK/kW}] \quad (\text{Kaplan, 5m head}) \quad [3.1.27]$$

$$K_{turbine} = 8039 \cdot Q^{-0,2218} \quad [\text{NOK/kW}] \quad (\text{Kaplan, 10m head}) \quad [3.1.28]$$

$$K_{turbine} = 6117 \cdot Q^{-0,1918} \quad [\text{NOK/kW}] \quad (\text{Kaplan, 20m head}) \quad [3.1.29]$$

where:

$K_{turbine}$	= Cost of turbine	[NOK/kW]
Q	= Flow rate	[m ³ /s]

These prices include turbine, turbine regulation, inlet valve, generator, control installation, switch gear and if necessary a transformer. The resulting curves are shown in figure 3.1.4.17. To obtain a reasonable price of what one plant costs has it been performed a linear interpolation between the equations 3.1.27, 28 and 29. If the head is higher than 20 meter is equation 3.1.29 used.

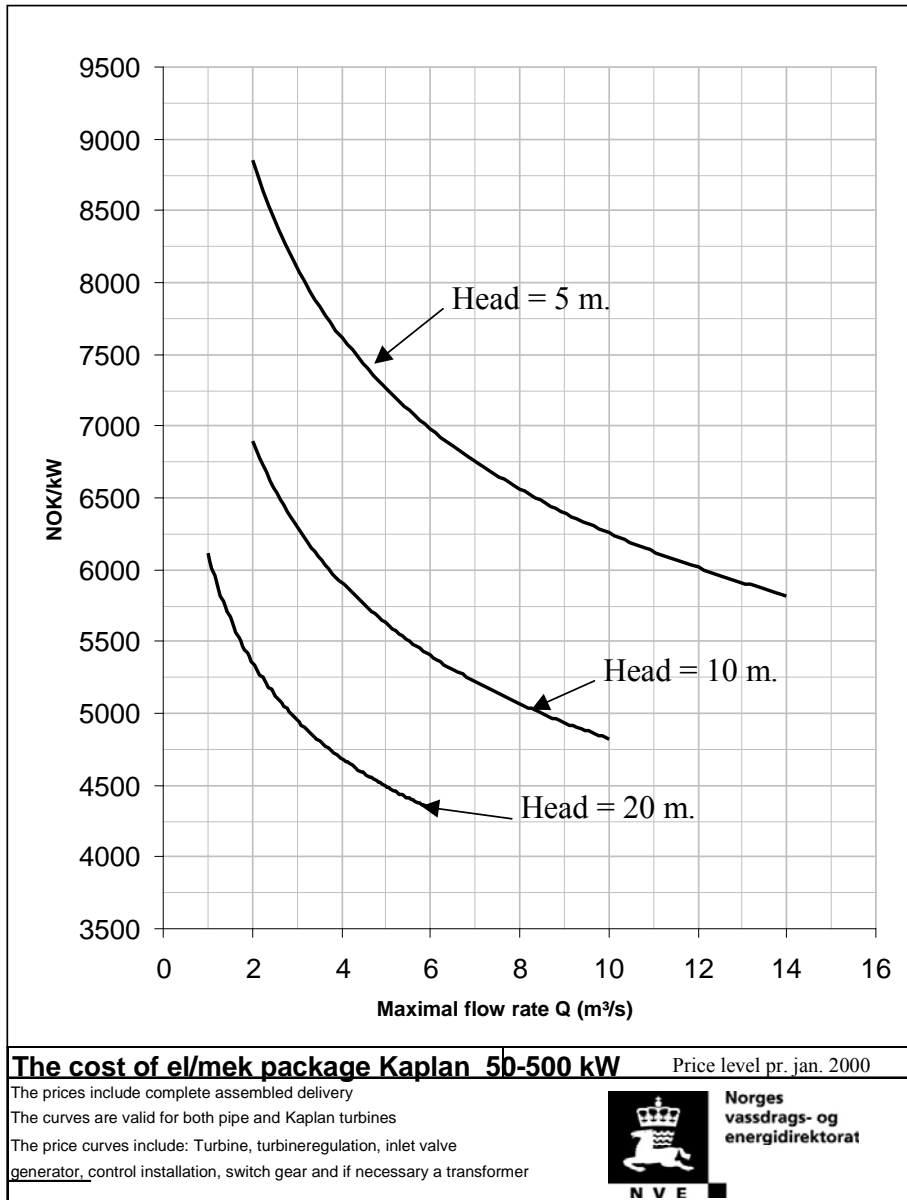

Figure 3.1.4. 17: The cost basis for Kaplan turbines with an effect between 50 and 500 kW

Kaplan turbines with an effect from 500 kW to 5000 kW

As a basis for the costs of Kaplan turbines has NVE developed a computation basis for 5, 19 and 20 meter head. This is equations 3.1.30, 31 and 32. For the cost calculations in this report, are these equations valid for turbines down to 5 kW.

$$K_{turbine} = 27462 \cdot Q^{-0,63} \quad [\text{NOK/kW}] \text{ (Kaplan, 5m head)} \quad [3.1.30]$$

$$K_{turbine} = 16106 \cdot Q^{-0,6483} \quad [\text{NOK/kW}] \text{ (Kaplan, 10m head)} \quad [3.1.31]$$

$$K_{turbine} = 9744 \cdot Q^{-0,6338} \quad [\text{NOK/kW}] \text{ (Kaplan, 20m head)} \quad [3.1.32]$$

where:

$K_{turbine}$	=	Cost of turbine	[NOK/kW]
Q	=	Flow rate	[m ³ /s]

These prices include turbine, turbine regulation and if necessary gear. The resulting curves are shown in figure 3.1.4.18. To obtain a reasonable price of what one plant will cost has it been performed a linear interpolation of the equations 3.1.30, 31 and 32. If the head is higher than 20 meters is equation 3.1.32 used.

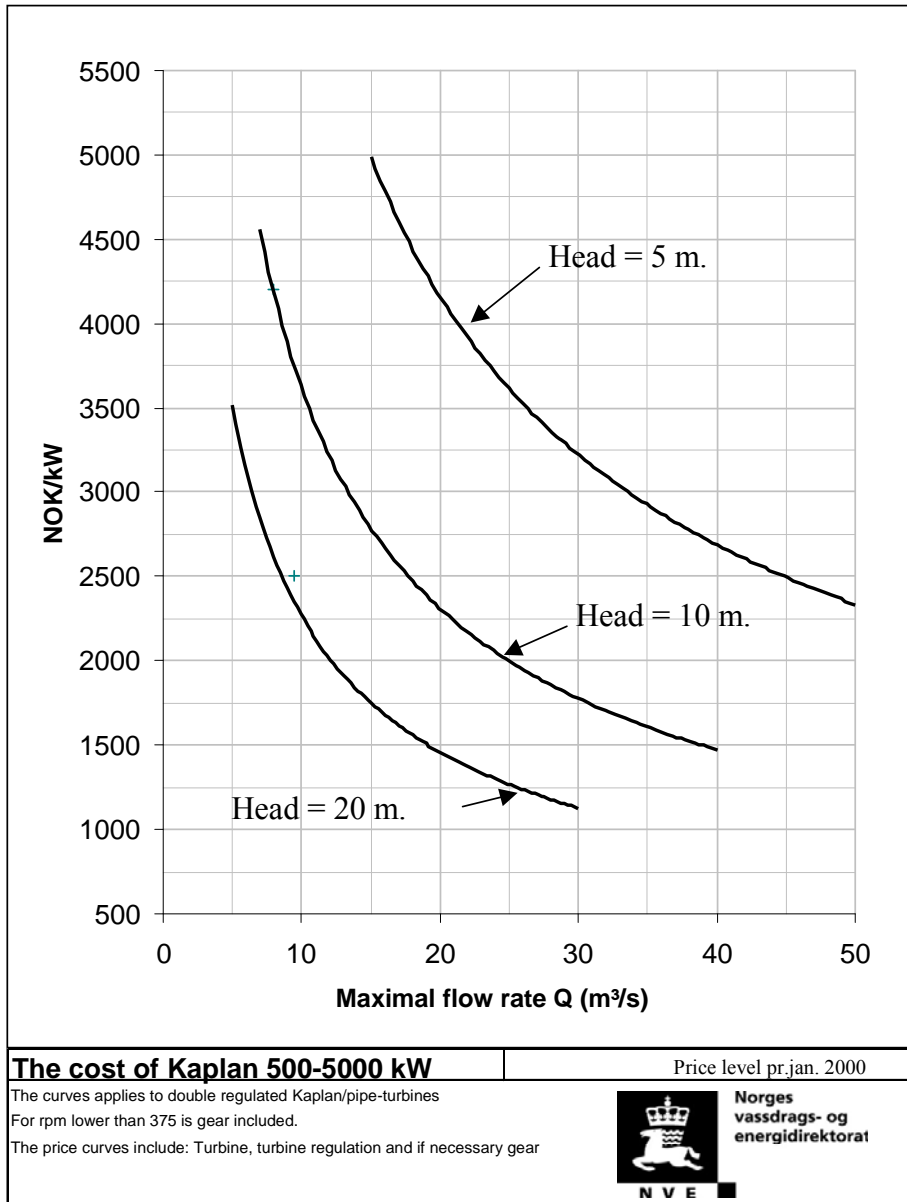

Figure 3.1.4. 18: Cost basis for Kaplan turbines with an effect between 500 and 5000 kW

3.1.4.2.7.2 The cost of sluice gate

At the intake basin of the power plants it is going to be assembled a sluice gate which will make it possible to drain the dam. It is possible to use different types of gates. In this report are three types of interest:

- ✓ Roller sluice
- ✓ Slide gate
- ✓ Gate barrier with wooden poles

For micro power plant it is presupposed use of a gate barrier with wooden poles which is a small cost for the contractor. In this report it is assumed that the contractor manufactures this gate himself, and the cost is set to be NOK. 5000,-.

For mini power plants is the choice of the sluicagate decided by the averaged flow capacity in the water course as shown below:

Flow rate < 1 m³/s here a gate barrier with wooden poles is chosen
Flow rate > 1 m³/s here a slide gate is chosen

For small power plants is the choice of sluicagate decided by the averaged flow capacity in the water course as shown below:

Flow rate < 2 m³/s here a slide gate is chosen
Flow rate > 2 m³/s here a roller sluice is chosen

The definitions of smaller hydropower plants are given in chapter 3.1.1.

The area of the gates is determined from equation 3.1.33.

$$A_{sluicagate} = \frac{Q_{average}}{C_{gate}} \quad [m^2] \quad [3.1.33]$$

where

A_{sluicagate} = Area of the sluicagate [m²]
Q_{average} = Averaged flow capacity in the watercourse [m³/s]
C_{gate} = Water velocity through the gate [m/s]

For the calculations in this report, is C_{gate} set to be 1 m/s at averaged flow capacity in the water course.

The costs of slide gates and roller sluices are given by equations 3.1.34 and 3.1.35 and presented in figure 3.1.4.19.

$$K_{slidegate} = 81923 \cdot A_{sluicagate} + 188308 \quad [NOK] \quad [3.1.34]$$

$$K_{rollersluice} = 84524 \cdot A_{sluicagate} + 266667 \quad [NOK] \quad [3.1.35]$$

where:

K_{slidegate} = Cost of slide gate [NOK]
K_{rollersluice} = Cost of roller sluice [NOK]
A_{sluicagate} = Area of sluicagate [m²]

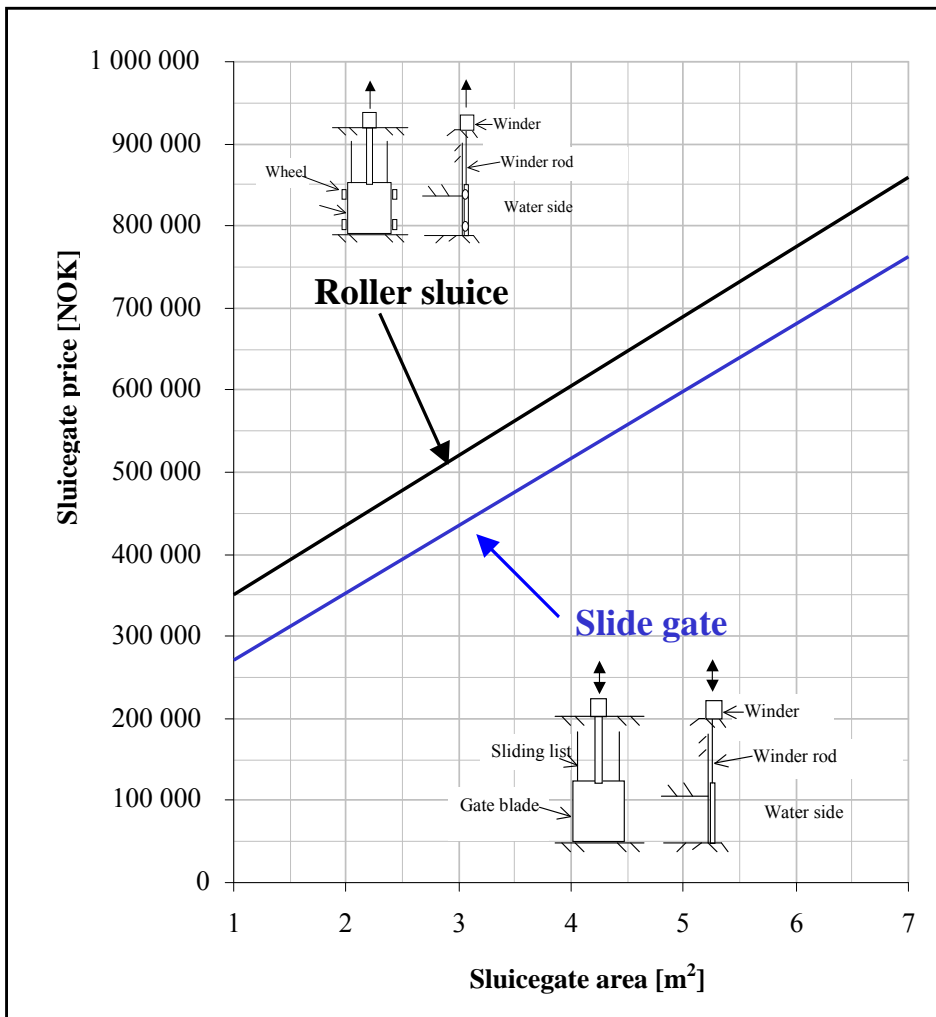

FIGURE 3.1.4. 19: THE COST BASIS OF SLIDE GATE AND ROLLER SLUICE.

3.1.4.2.7.3 The costs of inlet gate or valve

In many instances are valves used as the closing component at the intake of the penstock for a dam. In this report are the costs of valves and flanges calculated in accordance with equations 3.1.36 and 3.1.37. This is the prices of butterfly valves that are collected from K. Lund in Trondheim. When using a valve as the closing component, is it also necessary to install another valve that will let air into the pipe when the intake valve closes.

$$K_{valve} = 16750 \cdot D_r - 850 \quad [\text{NOK}] \text{ for } D_R < 0,3\text{m} \quad [3.1.36]$$

$$K_{valve} = 348727 \cdot D_R^4 - 805810 \cdot D_R^3 + 632823 \cdot D_R^2 - 146648 \cdot D_r + 9932 \quad [\text{NOK}]$$

for $D_R \geq 0,3\text{m}$ [3.1.37]

where

K_{valve}	= Cost of valve	[NOK]
D_R	= Pipe diameter	[m]

It has been decided to use a valve as the closing component if the diameter of the pipe is less than a meter, otherwise are gates used. There are additional costs connected to the use of a valve as the closing component. These are the air escape valve, flanges and work. In these calculations are this cost set to be NOK 2.500,- for pipe diameters smaller than 0,4 meter, and 30% of the valve cost for pipe diameters of 0,4 meter or larger.

The area of the inlet gate is set to be the same as the pipe's, and the choice of gate is determined by the averaged flow capacity through the power plant as shown below:

Flow rate	<	2 m ³ /s	here a slide gate is chosen
Flow rate	>	2 m ³ /s	here a roller sluice is chosen

The costs of slice gates and roller sluices are given by equations 3.1.34 and 35 and as illustrated in figure 3.1.4.19.

3.1.4.2.7.4 The cost of trashrack

It has been decided to produce the trashrack of synthetic material for the power plants discussed in this report. The trashrack is designed in a manner so the water velocity does not exceed 1 m/s. In addition, it is assumed that 33% of the area of the trashrack is taken up by the poles. The area of the trashrack is determined by equation 3.1.38 and the cost by equation 3.1.39. The cost is illustrated in figure 3.1.4.20. The cost of a trashrack cleaner is not taken into account in this report.

$$A_{\text{trashrack}} = \frac{Q_{\text{average}} \cdot 3}{C_{\text{gate}} \cdot 2} \quad [\text{m}^2] \quad [3.1.38]$$

$$K_{\text{trashrack}} = 3604 \cdot A_{\text{trashrack}} + 1414 \quad [\text{NOK}] \quad [3.1.39]$$

where:

- $K_{\text{trashrack}}$ = Cost of trashrack [NOK]
- $A_{\text{trashrack}}$ = Area of trashrack [m^2]
- Q_{average} = Averaged flow capacity through the power plant [m^3/s]
- C_{gate} = Water velocity through the gate = 1 m/s [m/s]

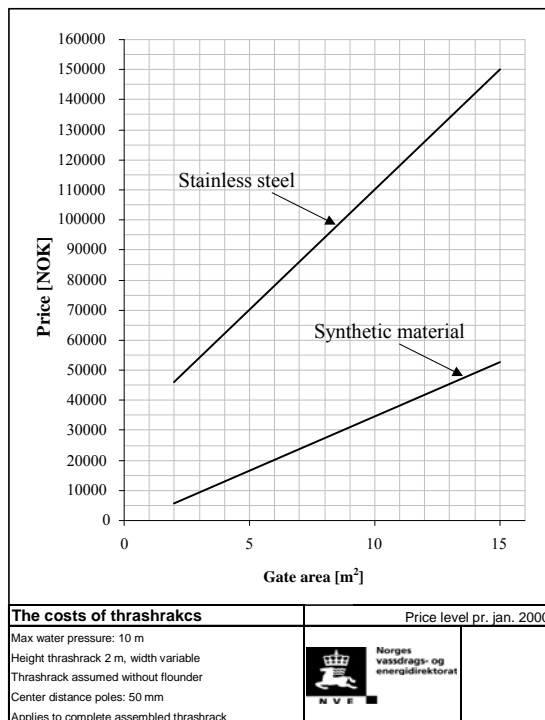

Figure 3.1.4. 20: Cost basis of thrashracks

3.1.4.2.7.5 The cost of lifting tackle in the power plant

In all power plants it is necessary to have the possibility to lift pipes, valve, turbine and generator. This equipment will be very different, depending on the weight of the parts the

lifting tackle has to handle. In this report it is assumed that it is used different types of lifting tackle depending on the weight:

Weight	Type of lifting tackle
0 - 1 tonn	single chain hoist
1 - 3 tonn	electric hoist with electric traverse carriage and chain
3 - 10 tonn	electric hoist with electric traverse carriage and wire

The heaviest parts that exist in a power plant are turbine and generator. These are delivered separately for larger power plants, and as one part for smaller plants. In this report it has been assumed a weight of turbine and generator as shown below:

Type of turbine	Effect [kW]	Generator [kg/kW]	Turbine [kg/kW]	Turbine and generator [kg]
Pelton	0 - 10			150 kg
Pelton	10 - 50			300 kg
Pelton	50 - 100			6 kg/kW
Pelton	100 - 1000			4 kg/kW
Pelton	1000 - 10000	3	1	
Francis	0 - 10			150 kg
Francis	0 - 50			300 kg
Francis	50 - 100			6 kg/kW
Francis	100 - 1000			4 kg/kW

The cost of one single chain hoist is set to be NOK 10.000,- and the cost of the other lifting tackle are determined by equations 3.1.40 and 41 and shown in figure 3.1.4.21.

$$K_{\text{liftingtackle-chain}} = 4945 \cdot \text{Weight} + 39780 \quad [\text{NOK}] \quad [3.1.40]$$

$$K_{\text{liftingtackle-wire}} = 8336 \cdot \text{Weight} + 48479 \quad [\text{NOK}] \quad [3.1.41]$$

where:

$K_{\text{liftingtackle-chain}}$ = Cost of electric hoist with electric traverse carriage and chain [NOK]

$K_{\text{liftingtackle-wire}}$ = Cost of electric hoist with electric traverse carriage and wire [NOK]

Weight = Weight of lifting tackle [kg]

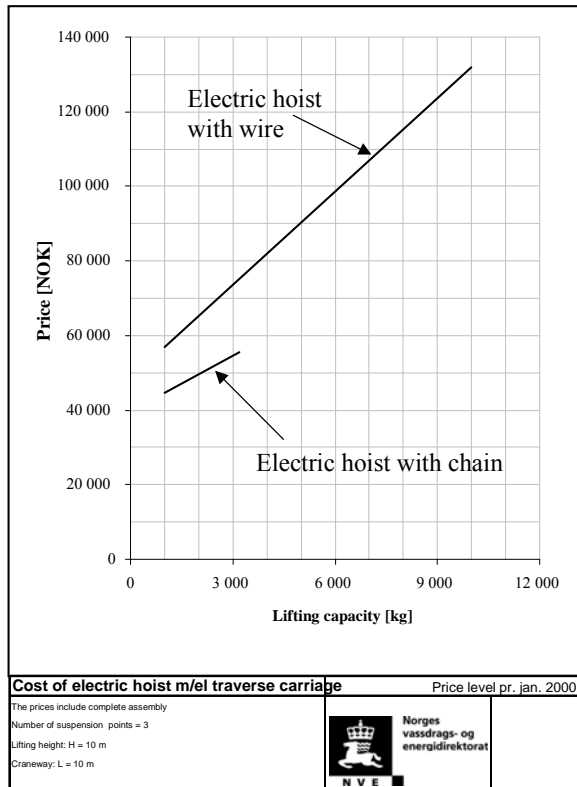

Figure 3.1.4.21: Costs basis for lifting tackle

3.1.4.2.7.6 The cost of pipes

On the market, it exist many types of pipes with different characteristics and prices. In this report will the following types of pipes be possible choices for the power plants:

- GUP-pipe
- PE-pipe
- Spirally welded steel pipe
- Ductile cast-iron pipe
- Prestressed
- Concrete pipe
- Wooden pipe

3.1.4.2.7.6.1 The cost of GUP-pipe

GUP-pipes are glass-fibre armed unsaturated polyester.

GUP-pipes are usually delivered in the following pressure classes and dimensions.

Pressure class	Delivered dimension [mm]
PN 6 and PN 10	from Ø 300 – Ø 2000
PN 16	from Ø 300 – Ø 1600
PN 25 and PN 32	from Ø 300 – Ø 1400

Good qualities:

Low weight, little problems with icing, well suited for embedment, little or no maintenance, no need for extra surface treatment, low head loss, chemical resistant, long lifetime.

Bad qualities:

Needs a good foundation and anchoring to avoid problems with the connections between the pipes, endures few hits, easily destroyed if rockslides hit the penstock etc.

The costs of the different GUP pipes are given by the equations 3.1.41 – 16 and shown in figure 3.1.4.22.

$$K_{GUP-PN6} = 1027 \cdot D_R^2 + 412 \cdot D_R + 114,4 \quad [\text{NOK/m}] \quad [3.1.42]$$

$$K_{GUP-PN10} = 1063 \cdot D_R^2 + 467 \cdot D_R + 98,8 \quad [\text{NOK/m}] \quad [3.1.43]$$

$$K_{GUP-PN16} = 1220 \cdot D_R^2 + 489 \cdot D_R + 103,2 \quad [\text{NOK/m}] \quad [3.1.44]$$

$$K_{GUP-PN25} = 1785 \cdot D_R^2 + 204 \cdot D_R + 218 \quad [\text{NOK/m}] \quad [3.1.45]$$

$$K_{GUP-PN32} = 2032 \cdot D_R^2 + 419 \cdot D_R + 181 \quad [\text{NOK/m}] \quad [3.1.46]$$

where:

$$\begin{aligned} K_{GUP-PN6} &= \text{Cost of GUP-pipe with pressure class PN-6} \quad [\text{NOK/m}] \\ K_{GUP-PN10} &= \text{Cost of GUP-pipe with pressure class PN-10} \quad [\text{NOK/m}] \\ K_{GUP-PN16} &= \text{Cost of GUP-pipe with pressure class PN-16} \quad [\text{NOK/m}] \end{aligned}$$

$K_{GUP-PN25}$ = Cost of GUP-pipe with pressure class PN-25 [NOK/m]
 $K_{GUP-PN32}$ = Cost of GUP-pipe with pressure class PN-32 [NOK/m]
 D_R = Pipe diameter [m]

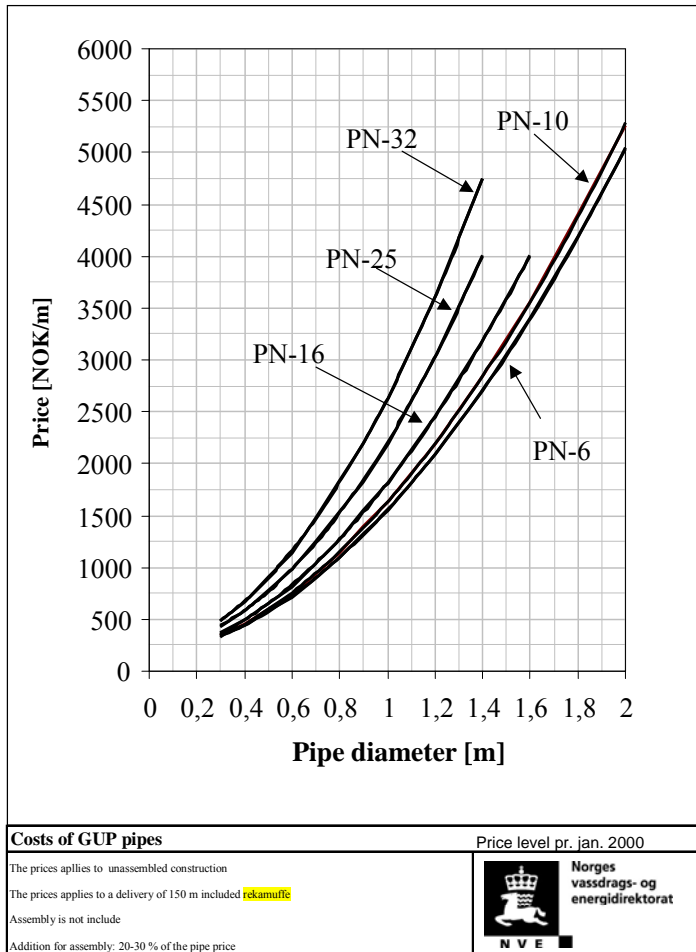

Figure 3.1.4. 22: The cost basis of GUP pipes

The costs of different bends for GUP pipes are given by equations 3.1.47 – 49 and shown in figure 3.1.4.23. The prices are only based on the prices for bends with pressure class PN-10

$$K_{GUPbend-90} = 2,89 \cdot D_R^6 - 9282 \cdot D_R^5 + 11704 \cdot D_R^4 - 72382 \cdot D_R^3 + 22666 D_R^2 - 31256 D_R + 18504 \quad [3.1.47]$$

$$K_{GUPbend-60} = 1,95 \cdot D_R^6 - 638 \cdot D_R^5 + 8184 \cdot D_R^4 - 51621 \cdot D_R^3 + 16538 D_R^2 - 23379 D_R + 14168 \quad [3.1.48]$$

$$K_{GUPbend-30} = 0,81 \cdot D_R^6 - 2625 \cdot D_R^5 + 3365 \cdot D_R^4 - 21381 \cdot D_R^3 + 7007 \cdot D_R^2 - 10090 D_R + 7207 \quad [3.1.49]$$

where:

- $K_{GUPbend-90}$ = Cost of 90° GUP-bend (PN-10) [NOK]
 $K_{GUPbend-60}$ = Cost of 60° GUP-bend (PN-10) [NOK]
 $K_{GUPbend-30}$ = Cost of 30° GUP-bend (PN-10) [NOK]
 D_R = Pipe diameter [m]

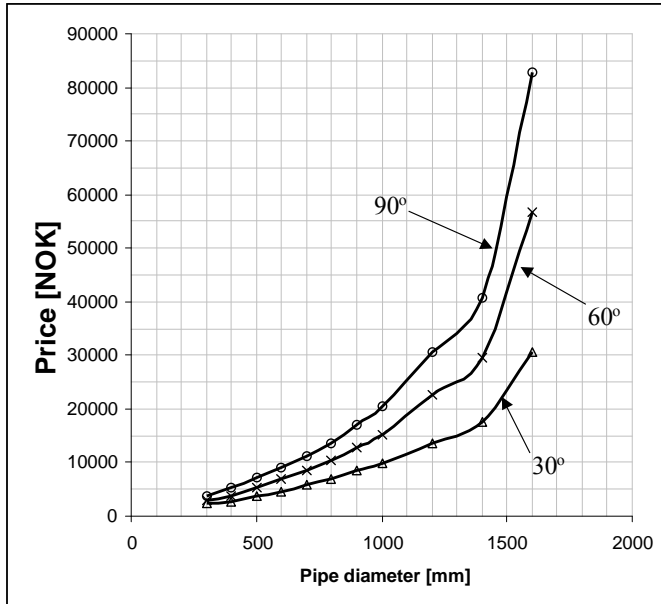

Cost of GUP-bend (PN-10) Price level pr. jan. 2000

The prices are valid for unassembled construction
 The price of bend include **rekamuffe**
 Assembly is not included
 Additional cost for assembly: 20-30 % of pipe price

Figure 3.1.4. 23: Cost basis for GUP-bend

3.1.4.2.7.6.2 The cost of PE-pipe

PE pipes are usually stocked for the following pressure classes and dimensions:

Pressure class	Delivered dimension[mm]
PN 4, PN6, PN10, PN16	from Ø 110 – Ø 630
PN25	from Ø 110 – Ø 315
For order PN4	Up to Ø 1200

When ordering PE pipes is the outer diameter given, in order to get the inner diameter must 2 x the material thickness be subtracted. The material thickness varies between 4 – 60 mm, depending on pressure class and pipe diameter.

In the cost estimate is inner diameter used as a parameter.

Good qualities:

The material can endure rough treatment on site, especially when it is cold, is placed in all-welded pipe section with an accuracy of 100% regarding the space between, does not need surface treatment, long life time, and small problems with icing

Bad qualities:

Low strength and stiffness in the material. Often, an inner rim formed in the pipe at each pipe connection when welding, which yields increased head loss in the penstock.

The costs of the different PE pipes are given by equations 3.1.50 – 54 and shown in figure 3.1.4.24.

$$K_{PE-PN25} = 2552 \cdot D_R^2 - 25,9 \cdot D_R + 2,6 \quad [\text{NOK/m}] \quad [3.1.50]$$

$$K_{PE-PN16} = 8538 \cdot D_R^2 - 238 \cdot D_R + 16,9 \quad [\text{NOK/m}] \quad [3.1.51]$$

$$K_{PE-PN10} = 4802 \cdot D_R^2 - 95,4 \cdot D_R + 8,6 \quad [\text{NOK/m}] \quad [3.1.52]$$

$$K_{PE-PN6} = 4094 \cdot D_R^2 - 89,1 \cdot D_R + 8,7 \quad [\text{NOK/m}] \quad [3.1.53]$$

$$K_{PE-PN4} = 2552 \cdot D_R^2 - 25,9 \cdot D_R + 2,6 \quad [\text{NOK/m}] \quad [3.1.54]$$

where:

$K_{PE-PN25}$	= Cost of PE pipe with pressure class PN-25	[NOK/m]
$K_{PE-PN16}$	= Cost of PE pipe with pressure class PN-16	[NOK/m]
$K_{PE-PN10}$	= Cost of PE pipe with pressure class PN-10	[NOK/m]
K_{PE-PN6}	= Cost of PE pipe with pressure class PN-6	[NOK/m]
K_{PE-PN4}	= Cost of PE pipe with pressure class PN-4	[NOK/m]
D_R	= Pipe diameter	[m]

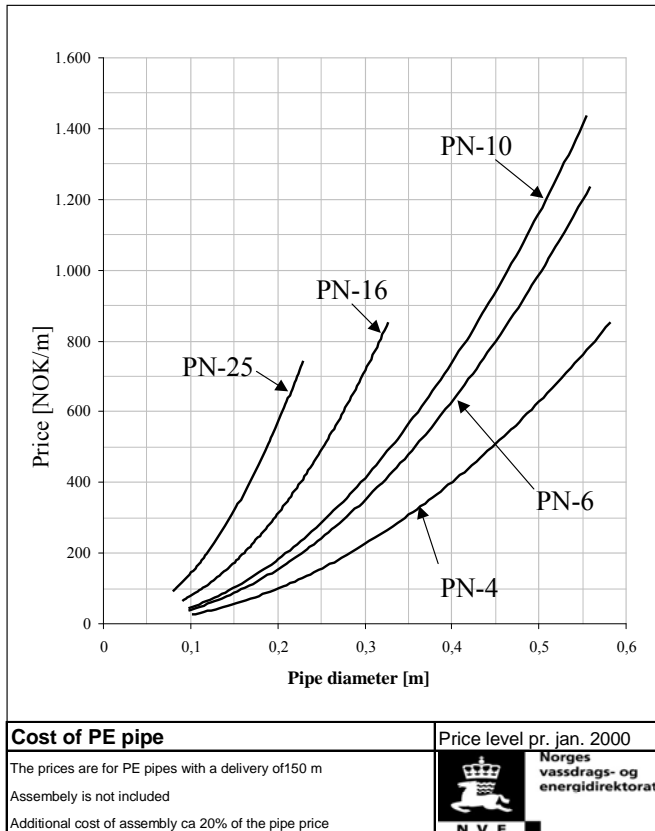

Figure 3.1.4. 24: The cost basis for PE pipes

3.1.4.2.7.6.3 The cost of spirally welded steel pipes

Spirally welded or longitudinal welded steel pipes are usually delivered with dimensions from Ø 200 – Ø 1400 mm, while longitudinal welded pipes are used for diameters below Ø 500/600 mm. Pipes after the DIN 2458/1626 standard are proof pressured to 50 bar = 500 m water column. When selecting material thickness should it be added a rust allowance on each side of the pipe.

These pipes have great strength and demands less anchoring compared to GUP pipes. They demand maintenance of the surface treatment and have a high weight. The welded joints demand a lot of work, especially at high wall thicknesses.

The costs for the different spirally welded steel pipes are given by equations 3.1.55 – 58 and shown in figure 3.1.4.25.

$$K_{SS-H600} = 5600 \cdot D_R^2 + 77 \cdot D_R + 197 \quad [\text{NOK/m}] \quad [3.1.55]$$

$$K_{SS-h400} = 6600 \cdot D_R^2 - 2925 \cdot D_R + 897 \quad [\text{NOK/m}] \quad [3.1.56]$$

$$K_{SS-H200} = 4293 \cdot D_R^3 - 6202 \cdot D_R^2 + 4782 \cdot D_R - 420 \quad [\text{NOK/m}] \quad [3.1.57]$$

$$K_{SS-H100} = 2000 \cdot D_R - 30 \quad [\text{NOK/m}] \quad [3.1.58]$$

where:

- $K_{SS-H600}$ = Cost of spirally welded steel pipe with pressure class H600 [NOK/m]
- $K_{SS-H400}$ = Cost of spirally welded steel pipe with pressure class H400 [NOK/m]
- $K_{SS-H200}$ = Cost of spirally welded steel pipe with pressure class H200 [NOK/m]
- $K_{SS-H100}$ = Cost of spirally welded steel pipe with pressure class H100 [NOK/m]
- D_R = Pipe diameter [m]

In this report it is assumed that it is used spirally welded steel pipes for power plants with a high head. The prices are therefore extrapolated down to Ø 100 m for these pipes.

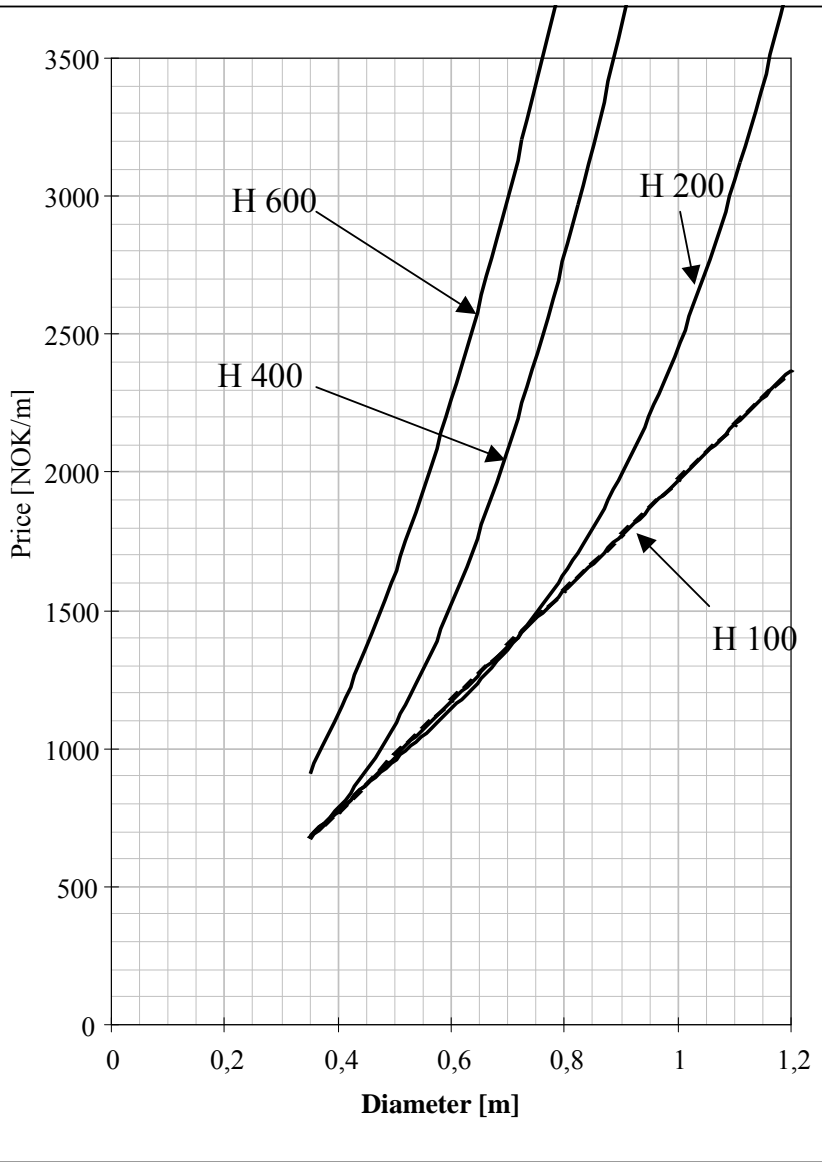

Cost of spirally welded steel pipes Price level pr. jan. 2000

The prices are given after delivery from factory included surface treatment,
 Material St 37,0 W
 The assembly costs are not included
 Assembly costs are set to be 25%



The prices are based on a delivery of ca. 500 m pipe

Figure 3.1.4. 25: Cost basis for spirally welded steel pipes

3.1.4.2.7.6.4 The cost of prestressed concrete pipes

Prestressed concrete pipes are delivered for diameters from Ø 500 – Ø 2000 mm, and can be used up to a inner overpressure of 200 m. These are delivered in a standard pipe length of 5 meters.

These pipes have a long life time, simple assembly and do not require any additional surface treatment. On the other hand are they not always permitted to use in detached penstocks. This pipe type has a high weight and is only delivered in short lengths. This involve that it can be challenging to place the pipe in difficult terrain.

The costs for the different prestressed concrete pipes are given by equations 3.1.59 – 61 and shown in figure 3.1.4.26. The cost of a 45 ° bend for prestressed concrete pipes is given by equation 3.1.66.

$$K_{SB-PN20} = 3429 \cdot D_R - 357 \quad [\text{NOK/m}] \quad [3.1.59]$$

$$K_{SB-PN6} = 3000 \cdot D_R - 300 \quad [\text{NOK/m}] \quad [3.1.60]$$

$$K_{SB-BEND} = 45000 \cdot D_R^2 - 57000 \cdot D_R + 31000 \quad [\text{NOK/m}] \quad [3.1.61]$$

where

$K_{SB-PN20}$ = Cost of prestressed concrete pipe with pressure class PN-20 [NOK/m]

K_{SB-PN6} = Cost of prestressed concrete pipe with pressure class PN-6 [NOK/m]

$K_{SB-BEND}$ = Cost of 45° bend for prestressed concrete pipes [NOK/m]

D_R = Pipe diameter [m]

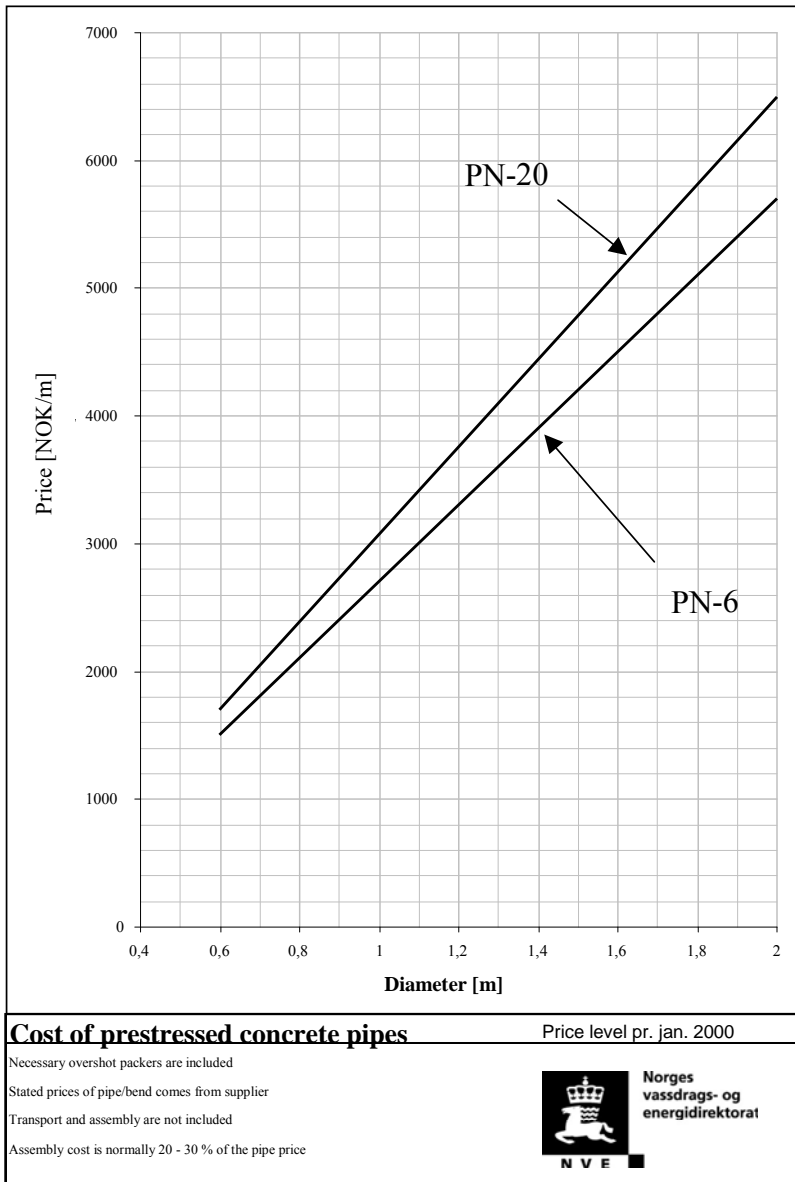

Figure 3.1.4. 26: Cost basis for prestressed concrete pipes

3.1.4.2.8 Cost of electrical work

The cost basis for the electrical work is developed by NVE and the project is allowed to use this in the cost calculations for micro and mini power plants, and can be found in the report: : "Kostnadsgrunnlag for mindre vannkraftanlegg (50-5000 kW)". The prices are valid for January 2000. In addition it is gathered some experience data from Gauldal Energy.

The price basis gives an overview of the electrical installations in power plants, and reflects the price level with normal delivery sizes and equipment. This concerns generator, transformer, control installation, switching station and power line.

For smaller power plants is it important that the electrical equipment is as simple as possible, but still functional and reliable. The price basis presupposes a control installation based on the static current principal and asynchronous generator for assemblies less than 1000 kW.

3.1.4.2.8.1 The cost of generator

The price basis applies to air-cooled generators with an effect in the range 500 – 5000 kW. Generators with an effect lower than 500 kW are usually always sold as a part of a package together with turbine and other equipment.

The cost of generators with an effect over 500 kW is given by equation 3.1.62 and shown in figure 3.1.4.27. The figure also illustrates the upper and lower price range of generators.

$$K_{GEN} = 2134 \cdot P^{0,8434} \quad \text{[NOK]} \quad \text{[3.1.62]}$$

Where:

$$\begin{array}{lll} K_{GEN} & = & \text{Cost of generator} \quad \text{[NOK]} \\ P & = & \text{Effect of generator} \quad \text{[kW]} \end{array}$$

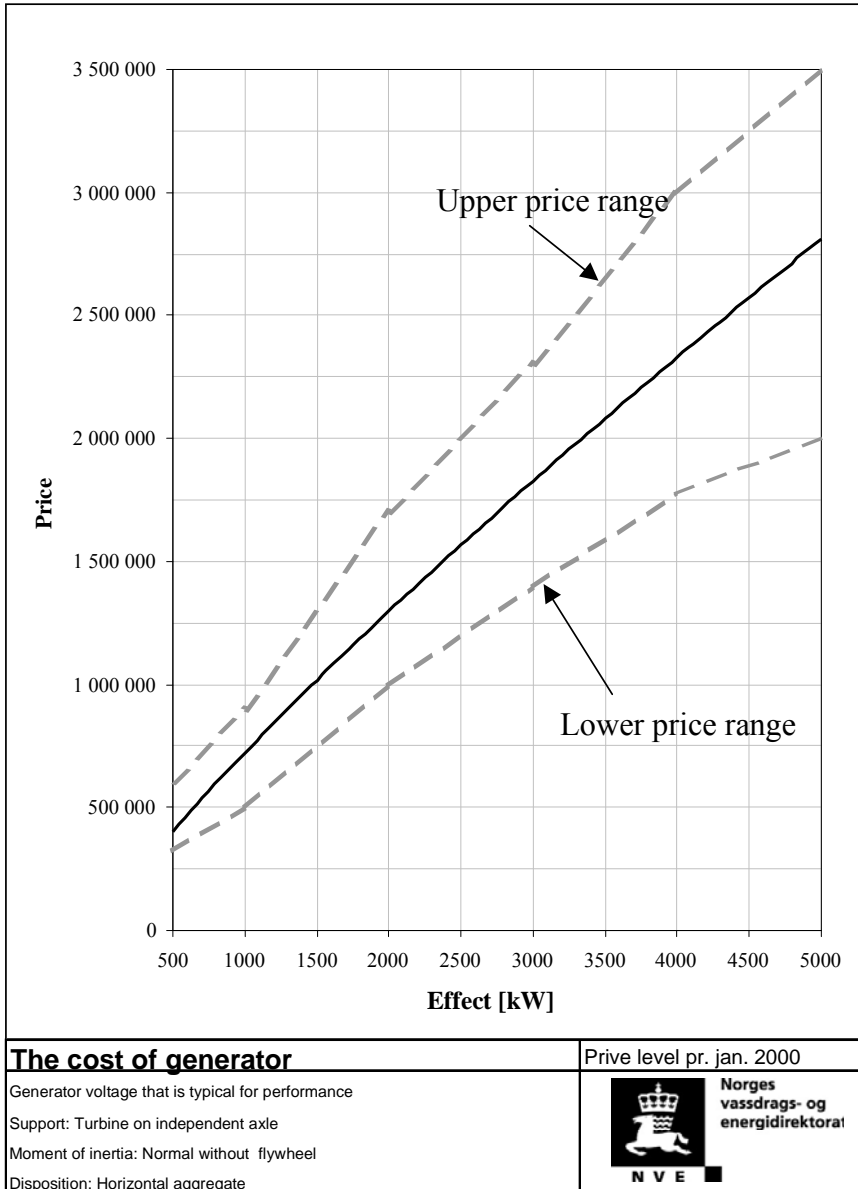

FIGURE 3.1.4. 27: THE COST BASIS OF GENERATORS WITH AN EFFECT OVER 500 KW

3.1.4.2.8.2 The cost of transformers

The price survey concerns transformers for delivery of energy to a 22kV distribution network.

It is usual that the transformer voltage can be adjusted in five stages with the help of a stage switch, which has been made for switching without voltage. Load switches which can adjust the voltage during operation are very expensive and not of interest for this type of plant.

It is not required with complicated control equipment for transformers for small power plants. Usually is it sufficient with a temperature controller for protection against over load, and for the largest power plants it can be necessary to have a sudden pressure relay.

Power stations with a generator voltage larger than 400 V must have a station transformer for supplying auxiliary current to the plant. This is small transformers, often dry insulated, only intended to supply pump motors, fan motors, battery chargers and other utility equipments. Typical prices for station transformers are about NOK. 15.000,- to NOK 30.000, for effect between 25 and 50 kVA.

The cost of transformers for delivery of energy to a 22kV distribution network with an effect over 500 kW is given by equations 3.1.63 – 64 and shown in figure 3.1.4.28. The figure illustrates upper and lower price level of transformers.

$$K_{TRANS\ 1600-5000} = 75,4 \cdot P + 52206 \quad [\text{NOK}] \quad [3.1.63]$$

$$K_{TRANS\ 50-1600} = 67,1 \cdot P + 29258 \quad [\text{NOK}] \quad [3.1.64]$$

where

$$K_{TRANS\ 1600-5000} = \text{Cost of transformer in the power range 1600 - 1 5000 kW} \quad [\text{NOK}]$$

$$K_{TRANS\ 50-1600} = \text{Cost of transformer in the power range 50 -1600 kW} \quad [\text{NOK}]$$

$$P = \text{Effect of generator} \quad [\text{kW}]$$

The cost of transformers with the voltage 1000/230 Volt is in accordance with equation 3.1.65.

$$K_{TRANS\ 1000/230} = \left[\frac{P}{50} \right] \cdot 25000 \quad [\text{NOK}] \quad [3.1.65]$$

$$K_{TRANS\ 1000/230} = \text{Cost of transformer with the voltage 1000/230 V} \quad [\text{NOK}]$$

$$P = \text{Effect of generator} \quad [\text{kW}]$$

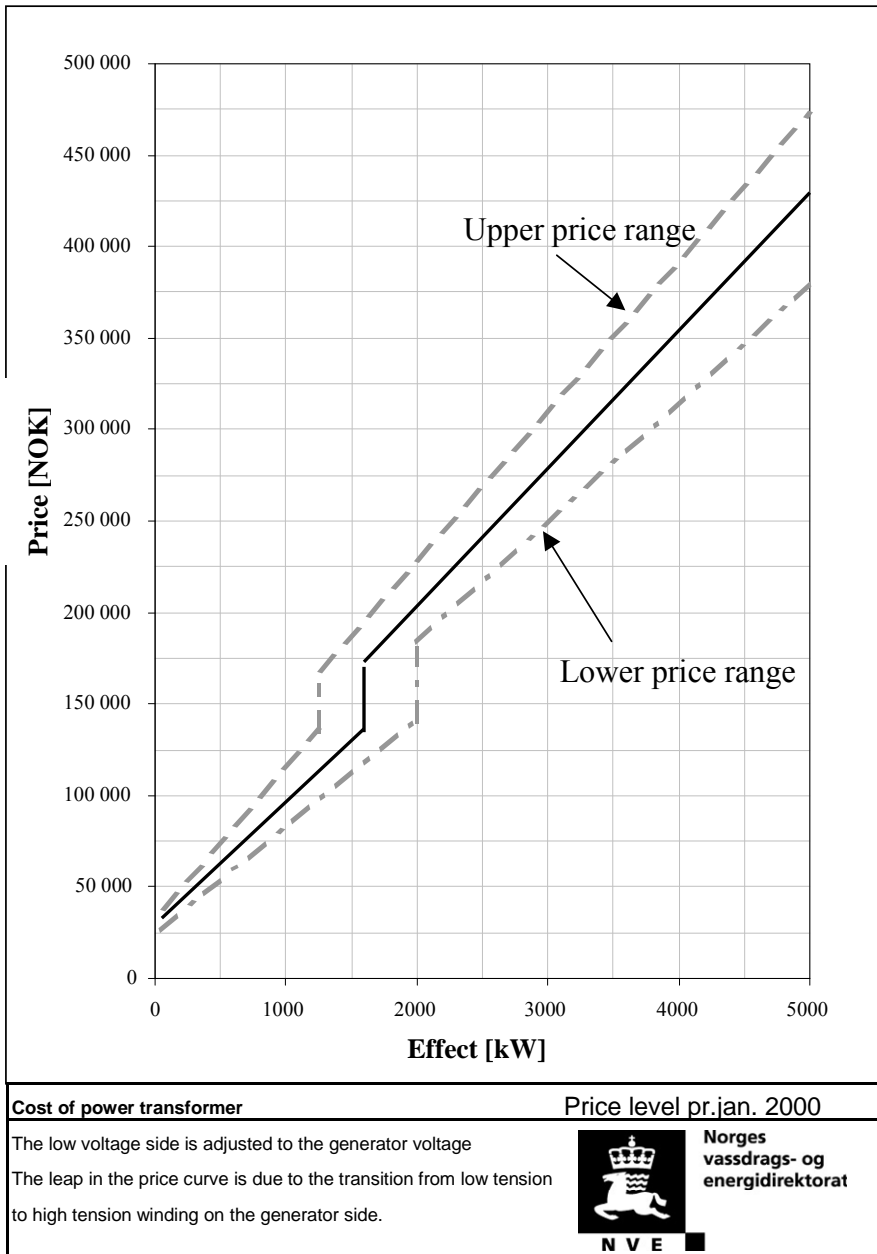

FIGURE 3.1.4. 28: THE COST BASIS FOR TRANSFORMER

3.1.4.2.8.3 The cost of control installation

A control installation usually consists of:

- Assemblies control
- Generator protection

- Remaining protection of switching station and of power transformer
- Control operation of switching station
- Water level regulation
- Remote control (SCADA)
- Battery with charging rectifier

Assemblies control involves the start and stop functions of the assemblies and its auxiliary functions. Generally is equipment for automatic synchronization and water level regulation integrated in the control installation. The operation of the power plant should be as automated as possible. It is the type of watercourse and the operation philosophy that decides the extent of the automatic controls.

For many of the small power plants, maybe with an exception of the smallest ones, will remote control be of interest. This can be delivered as simple systems well suited for small plants, only designed to transmit a few signals over a regular telephone line or other communication means. Power plants that deliver energy to the interconnected power network are required to have an hourly kWh recorder, and which is possible to remote read by the network owner

The basis for the prices has been limited, due to the fact that control installations and switching stations often are delivered as a package from the supplier. The price curve indicates that large differences in the prices are to be expected, depending on quality and complexity. The control installations function and equipment are not necessarily in proportion to the size of the assemblies, but are determined from the extent of instrumentation and automation, and type of remote control etc.

The generator protection includes at a minimum:

- Overload/short circuit protection
- Reverse power protection
- Earth fault protection relay

And if necessary:

- Over-/undervoltage protection (only for synchronizing machines)
- Differential protection (customary for machines larger than ca. 2000 kVA)
- Other

Remaining protection exists of:

- Overload/short circuit protection for outward bound lines
- Earth fault protection relay for outward bound lines
- Other

The cost of control installations with an effect over 500 kW is given by equations 3.1.66 – 69 and shown in figure 3.1.4.29. The figure also illustrates upper and lower price levels of control installations.

$$K_{Kont\ 3000-5000} = 1500000 \quad [NOK] \quad [3.1.66]$$

$$K_{Kont\ 2000-3000} = 950000 \quad [NOK] \quad [3.1.67]$$

$$K_{Kont\ 1000-2000} = 550000 \quad [NOK] \quad [3.1.68]$$

$$K_{Kont\ 500-1000} = 200000 \quad [NOK] \quad [3.1.69]$$

where:

- $K_{Kont\ 3000-5000}$ = Cost of control installation with an effect from 3000 kW to 5000 kW [NOK]
- $K_{Kont\ 2000-3000}$ = Cost of control installation with an effect from 2000 kW to 3000 kW [NOK]
- $K_{Kont\ 1000-2000}$ = Cost of control installation with an effect from 1000 kW to 2000 kW [NOK]
- $K_{Kont\ 500-1000}$ = Cost of control installation with an effect from 500 kW to 1000 kW [NOK]

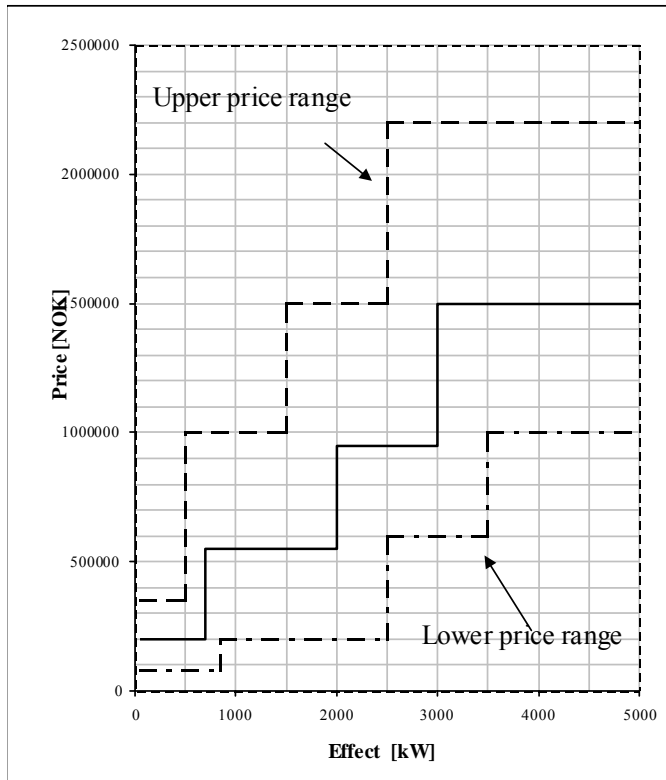

Cost of control installation Price level pr. jan. 2000
 The following equipments are included:
 - Assemblies control
 - Generator protection
 - Battery installation with rectifier



Figure 3.1.4. 29: The cost basis of control installation

3.1.4.2.8.4 The cost of switching station

It is presupposed that the delivery end on the station wall, i.e. include high-voltage switch gear, but exclusive of cable connections to high-tension line.

The network owner will demand a connecting fee to cover their investment costs. They will be registered as the owner of the high-tension installation and have operation and maintenance responsibility, unless the developer can satisfy official requirements. This cost should be included in the total cost of the power plant.

Condensor battery

The network owner can demand that it is install a condenser battery to power capacitate power plants with asynchronous machines. This can reduce some of the price advantage which asynchronous installations have over synchronous installations.

The costs of switching stations with an effect over 500 kW are given by equation 3.1.70 and shown in figure 3.1.4.30. The figure also illustrates upper and lower limit of the price level of switching stations.

$$K_{Kopl} = 632 \cdot P^{0,9755} \quad \text{[NOK]} \quad \text{[3.1.70]}$$

where

K_{Kopl}	=	Cost of switching station	[NOK]
P	=	Effect of generator	[kW]

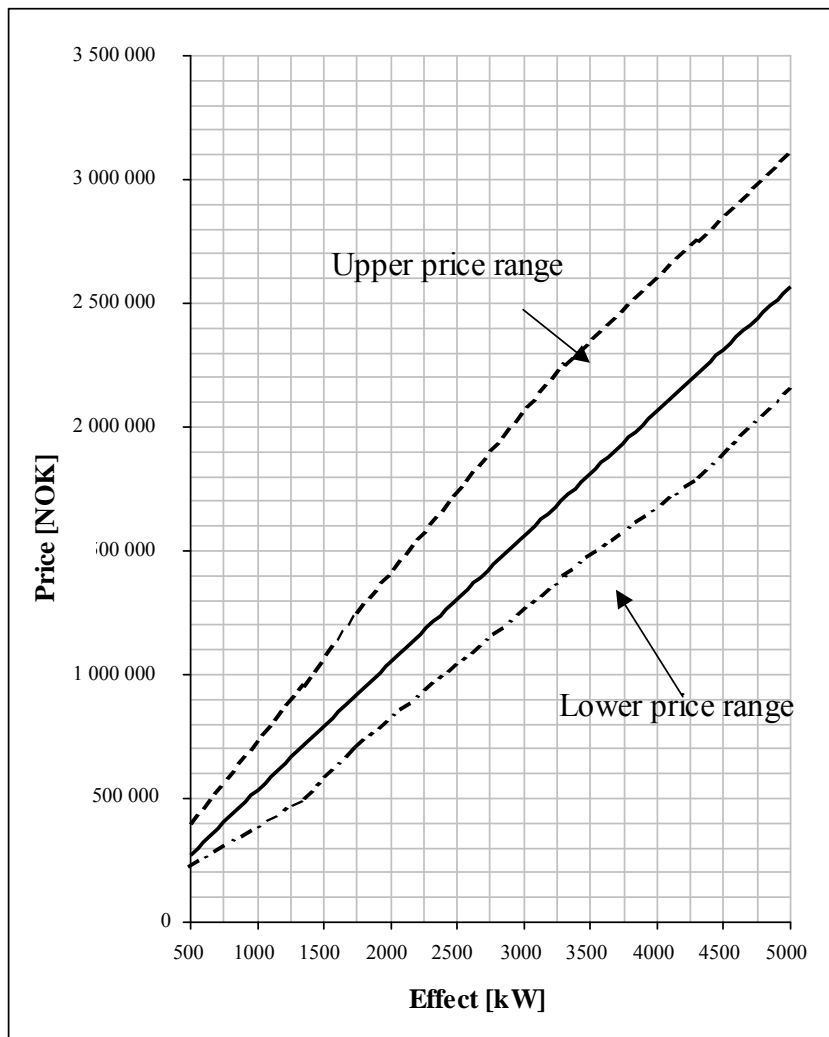

Cost of switching station Price level pr. jan. 2000

The following equipments are included:

- Generator breaker
- If high-voltage switchgear(-s)
- If station transformer

Figure 3.1.4. 30: The cost basis of a switching station

3.1.4.2.8.5 The cost of power line

In this report are experiences from Gauldal Energy the basis of the cost concerning the power line. This cost is set to be NOK. 300,- per meter power line. The length is based on the distance from power plant to the nearest domestic building or line. Here are Gauldal Energy's own maps used.

The selection of voltage level, U, of the generator is selected from the following criteria:

U = 230 Volt if the power line from the power plant to the network or domestic building is less than 500 meter

U = 1000 Volt if the power line from the power plant to the network or domestic building is longer than 500 meter.

Excavation of earth trench, erecting poles and laying of cable cost:

$$K_{cablew} = K_{eartht} \cdot L_{eartht} + (K_{pole} + K_{polew}) \cdot \frac{L_{airs}}{L_{pole}} \quad [\text{NOK}] \quad [3.1.71]$$

where

K_{cablew}	=	Cost of cable work		[NOK]
K_{earth}	=	Cost of excavation of earth trench	60	[NOK/m]
L_{earth}	=	Length of earth trench		[m]
K_{pole}	=	Cost of one pole	2000	[NOK]
K_{polew}	=	Labour cost for erecting one pole	1000	[NOK]
L_{airs}	=	Length of air stretch		[m]
L_{pole}	=	Length between each pole	50	[m]

The cost of the earth cable is calculated from costs of the different types of cables that are used. It is the current which determines the size of the cross-section that is used in the cables. The cost of earth cable is calculated in accordance with equations 3.1.71 – 75:

$$K_{cabel} = 40 \text{ [NOK/m]} \text{ if } I < 150 \text{ [A]} \quad [3.1.72]$$

Maximal length of this cable is 50 meter

$$K_{cabel} = 60 \text{ [NOK/m]} \text{ if } 150 \text{ [A]} \leq I < 220 \text{ [A]} \quad [3.1.73]$$

Maximal length of this cable is 150 meter

$$K_{cabel} = 90 \text{ [NOK/m]} \text{ if } 220 \text{ [A]} \leq I < 300 \text{ [A]} \quad [3.1.74]$$

Maximal length of this cable is 300 meters

$$K_{cabel} = 140 \text{ [NOK/m]} \text{ if } 300 \text{ [A]} \leq I < 350 \text{ [A]} \quad [3.1.75]$$

Maximal length of this cable is 500 meters

The cost of aerial cable is calculated from the cost of the different types of cable that are used. It is the current which determines the size of the cross-section that is used in the cables. Equations 3.1.76 – 77 show how the cost of an aerial cable is calculated.

$$K_{\text{aerialcabel}} = 20 \text{ [NOK/m]} \text{ if } I < 100 \text{ [A]} \quad [3.1.76]$$

Maximal length of this cable is 100 meters

$$K_{\text{areialcable}} = 40 \text{ [NOK/m]} \text{ if } 100 \text{ [A]} \leq I < 160 \text{ [A]} \quad [3.1.77]$$

Maximal length of this cable is 500 meters

3.1.4.2.9 The cost of engineering and project management

The engineering and management costs at norwegian SHP projects are normally 10-20% of the total project costs, depending on the project scope: Sometimes it is introduced high risk elements and some projects are more labor intensive, because of technical, site specific challenges.

In the financial analysis of this project the initial investment costs consist of the HPP component cost with an additional 10 % for contingencies and another 10 % added for the project management costs (engineering and administration).

3.1.4.2.10 Annual costs

The annual costs for the HPP include operation and maintenance costs, taxes, amortization and interest on capital. Operation and maintenance costs are 20 NOK/MWh for installations less than 1 MW, and for installations of greater than 1 MW are 40 NOK/MWh. The interest rate, or the time value of capital is, 5,8 %. The cash flow is converted to present-values with a fixed discount rate.

3.1.4.2.11 Economic life

The economic life of the projects depends on the lifetime of the equipment. Depending of the quality, the lifetime of the electro/mechanical components can last for so long as 50-60 years.

As a compromise for all of the components together a lifetime of 30 years is normally set. For the controller a lifetime for 10 years is set.

3.1.4.2.12 Financing strategy

In Norway, with no possibilities for governmental financial support, the only financing strategy is a private loan, or an investor. There are no Green certificates that provides additional income per kWh.

3.1.4.2.13 Revenue assessment –value of energy based upon market analysis or demand capability

The physical market functions (spot) primary function is to establish a balance between supply of and demand for electricity on the following day. This job is extremely important because power shortages carry very substantial socio-economic costs.

The physical market price on the Nordic power market, Nord Pool, is set in the same way as on other commodity exchanges – through a market pricing. The difference compared with

other markets is that electricity is a commodity which must be generated and consumed simultaneously. This makes very special demands on output planning.

A well-functioning power market ensures that electricity gets generated wherever the cost of generation is lowest at any time of the day. Increases in demand will be balanced against more expensive modes of generation. That also gives the market an indication of what it would take to establish new generating capacity.

In socio-economic terms, this provides a clear indication of the cost society would have to bear to incorporate new output in the system.

Where commercial considerations are concerned, generators will receive a good indication of where the break-even point lies for developing new generating capacity.

Nord Pool's physical market also ensures that power supply and demand are balanced right up to one hour before the time of consumption.

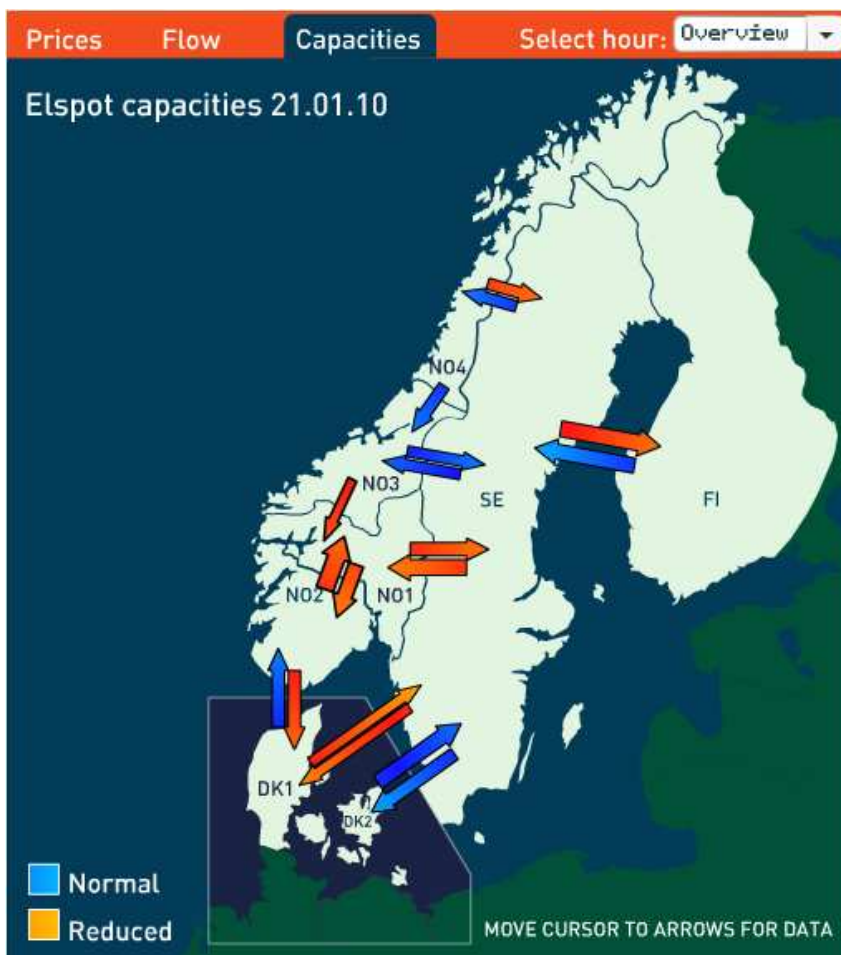

Figure 3.1.4. 31: The Nordic power market (website: Nordpool, 2010)

According to provisions for system responsibility in the power system (FoS), Statnett shall define Elspot/Elbas areas in order to deal with major and long-term congestions in the regional and central grid system, or possible lack of energy in defined geographical areas.

Currently Norway is divided in four regions which operates with different prices. The reason for this segmentation is limitations in the power grid, implying constraints in the distribution capacity. Statnett continuously assess the grid capacity between the regions, and evaluates if one region has a surplus or shortage of power production related to the regional demand.

Electricity is bought and sold at Nord Pool (the Nordic power market) and it is difficult to predict the exact price. Experts do make prognosis from the precipitation, energy demand etc. but they are uncertain. The energy demand is influenced by amongst other factors weather and the energy-intensive industry.

System price 20 Jan 2010

€	NOK	SEK	DKK
47.50	387.52	481.23	353.45

Prices last 30 days in €

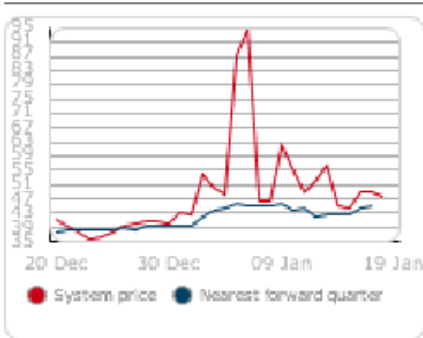

Figure 3.1.4.32: The figure shows how the price was influenced of, among other factors, cold weather in the beginning of January 2010 (website: Nordpool, 2010)

3.1.4.2.14 Financial analysis and criteria for decision

The cost/benefit analysis shows the possible feasibility of the projects. It is important to not only rely on one single of these parameters, but to consider them all. The results of the financial analysis should be put in a table, so that the potential best SHP projects can be discovered. The results of the financial analysis of nine rivers in Holtålen are presented in the deliverable D4.1.

Table 3.1.4.1: Example of results of an economic analysis for nine rivers

Rivers	Scope [NOK/kWh]	Initial investment [mill. NOK]	Energy Output [kWh]	NPV [NOK]	PB [year]	Benefit/cost ratio	IRR [%]
Bælingen	1,64	12,53	7630572	16661621	8	2,33	16,4
Lea	2,26	14,79	6541680	10675825	12	1,72	11,8
Nørdre Gisla	2,23	4,11	1838429	3415974	11	1,83	12,7
Renåa	4,59	6,13	1335988	-318634	>30	0,95	5,3
Drøya	3,27	6,38	1949100	1815943	18	1,28	8,3
Benda	6,33	5,33	841384	-1508451	>30	0,72	3,0
Storrena	4,42	5,43	1228546	-106932	>30	0,98	5,6
Nørdre Finnsåa	4,57	4,56	996536	-224655	>30	0,95	5,3
Søndre Tverråa	3,30	5,65	1711307	1549809	19	1,27	8,2

Payback period:

The PB period demonstrates the liquidity of the investment, that is, the capacity to transform the activities to money through exploitation. The rivers that compensate the initial costs before the end of the period of analysis are Bælingen, Lea, Nørdre Gisla, Drøya and Søndre Tverråa. A maximum time for the PB period should not exceed 30 years.

$$\sum_{t=0}^T CF_t = 0 \rightarrow PB = T \quad [3.1.78]$$

Where:

CF_t - cash flow of the period t.

T - number of years.

Scope/ unit cost of energy:

The unit cost of energy, or scope, is a useful parameter for ranking HPP projects. This economic parameter considers the energy output and the initial investment cost of the power plant. However, scope does not take into account the energy prices, income and reduction of costs from the landowner's own labour. Projects with a scope below 3 NOK/kWh are considered as feasible projects (Vøkso et al., 2005). So, Bælingen, Nørdre Gisla and Lea are feasible projects. Drøya and Søndre Tverråa have a scope around 3 NOK/kWh and are also considered worthwhile projects.

$$Scope = \frac{Initial\ Investment\ [NOK]}{Average\ Energy\ Output\ [kWh]} \quad [3.1.79]$$

Present Value:

The PV is a dimensionless ratio that shows how the benefits exceed costs in percentage (Gulliver et al., 1991). Feasible rivers according to this ratio are Bælingen, Lea, Nørdre Gisla, Drøya and Søndre Tverråa.

$$\frac{PV(Benefits)}{PV(Costs)} > 1 \quad [3.1.80]$$

The Net Present Value:

If the NPV is negative, then, in theory, it is not worth investing in the project. Bælingen, Lea, Nordre Gisla, Drøya and Søndre Tverråa seem profitable according to net present value:

$$NPV = \sum_{t=0}^n \frac{CF_t}{(1+i)^t} \quad [3.1.81]$$

Where:

i - interest rate

n - horizon of the project.

The Internal Rate of Return:

The IRR has the advantage of not using an arbitrarily selected discount rate. IRR should be higher than the interest rate. According to this factor, interesting rivers to develop are Bælingen, Lea, Nordre Gisla, Drøya and Søndre Tverråa.

$$NPV = 0 = \sum_{t=0}^n \frac{CF_t}{(1+r)^t} \rightarrow r = IRR \quad [3.1.82]$$

IRR and NPV give quantitative information about the profitability of the project.

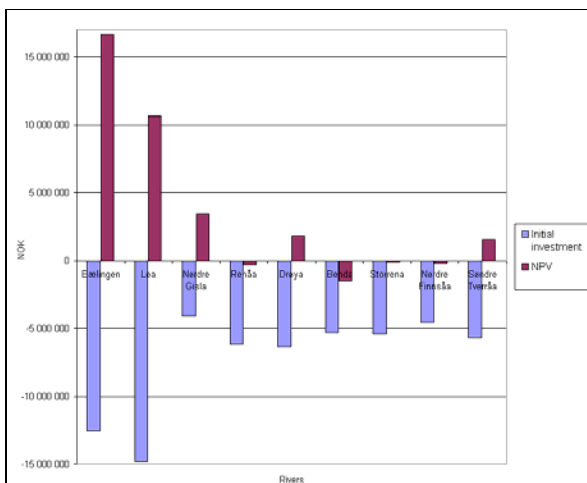

Figure 3.1.4. 33: Investment cost and net present value of all the rivers.

Having analysed the potential sites, a list of priority is set to determine the best projects to be considered for implementation, based on the economic analysis.

Table 3.1.4. 2: Example of list of priority for SHP projects

List of priority	Rivers	Power output [kW]	Scope [NOK/kWh]	NPV [NOK]	PB [years]	IRR [%]
1	Bælingen	1 330	1,64	16 661 621	8	16,4
2	Lea	1 138	2,26	10 675 825	12	11,8
3	Nørdre Gisla	322	2,23	3 415 974	11	12,7
4	Drøya	340	3,27	1 873 940	18	8,3
5	Søndre Tverråa	298	3,3	1 549 809	19	8,2
6	Storrena	126	3,87	286 912	24	6,7
7	Benda	174	4,47	-132 587	>30	5,5
8	Nørdre Finnsåa	175	4,57	-224 655	>30	5,3
9	Renåa	234	4,59	-318 634	>30	4,6

According to this priority list, Bælingen, Lea and Nørdre Gisla seem to be very profitable projects and worth further investigation. Drøya, Søndre Tverråa and Storrena are also in the range of profitability. In addition, Benda, Nørdre Finnsåa and Rennåa have a scope below 5 NOK/kWh and it is not inconceivable that in the future, these power plants could be implemented economically. At the time this was written, SHPPs with a scope around 3,5-4 NOK/KWh are build in Norway. Some landowners of the river build the HPP by themselves, with their own materials and labour, which improves the project's economy.

During a field survey, the appropriateness of the intake and the station locations initially pinpointed on the map, the difficulty of the terrain and the soil conditions can be verified. The economic analysis is based on fixed parameters that would likely be going to change in the near future.

The cost of the components of the hydropower plant are based on the NVE cost functions from 2000 that can be updated with a price increase. It is merely estimation, as prices are constantly changing. A market survey is highlighted in order to find the optimal supplier, reducing the capital cost.

3.1.5 SHP program tools for Cost/ benefit analysis

Three user friendly program tools are developed at NTNU in order to simplify the task of discovering potential profitable SHP projects. In particular the SHP optimisation program, which is the most advanced of the three programs, proved to be very useful for a preliminary technical and financial study discovering potential profitable sites for SHP construction.

The program tools, are basically based on the methodology described in chapter 3.1.1 and 3.1.4, but they are made so that default values easily can be adjusted to fit the case you want to study. The importance of presenting the input parameters for the projects together with the results needs to be stressed. The program tools were tested on the pilot region of Holtålen and the results are presented in deliverable D4.1 in work package 4 of the SMART project.

3.1.5.1 SHP programs, methodology

All the programs are programmed with Microsoft Office Excel 2003, as it is user friendly and used worldwide. The whole program algorithm is available with thorough comments in order to ease the work if it is needed to improve or update the programs at some day in the future.

The results of the cost functions are given in NOK (Norwegian Kroner), but as this is an EU-project you can choose to get the results in Euro or different currencies of the member states. The exchange rate and price increase due to inflation may be updated by the user in the programs.

The user can see the cost functions and their range of validity in the worksheet. The coefficients of the costs equations and the limits can be freely modified in the table. The costs are determined automatically by the program, as the validity of the equations depends on the range of operation.

It is the user's responsibility to make sure that the input data is coherent with the validity range.

The program is run by pressing the "Run Small Hydropower plants program" button in the "Calculate" Worksheet, shown in Figure 3.1.5.1. The methodology of these algorithms is based on transferring data to and from the worksheets. The values introduced by the user in the macros are set into the correspondent cell of the worksheet and the results calculated on the worksheet are displayed in the macros.

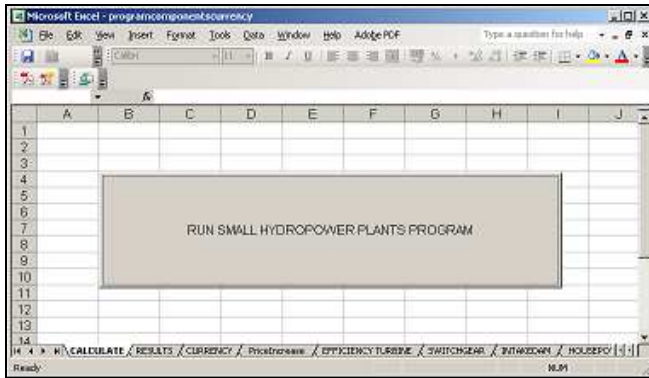

Figure 3.1.5.1: Command Button to run the programs “SHP Global view” and “SHP Individual view”

3.1.5.1.1 Cost of the small hydro power plants components

The cost of the hydropower plant consists of the individual costs of its components: intake dam, intake gate or valve, trash rack, pipes, powerhouse, turbine, generator, crane, transformer, controller, switchgear and power cable, which are technically described. These costs are based on statistical functions from the Norwegian Water Resources and Energy Directorate (NVE).

The NVE cost functions have a format such as the following equations:

$$K = a_4 \cdot X^4 + a_3 \cdot X^3 + a_2 \cdot X^2 + a_1 \cdot X^1 + a_0$$

$$K = a_1 \cdot \ln(X) + a_0$$

$$K = a_1 \cdot X^{a_0}$$

The input data for the cost functions are the flow, head, soil type, turbine type, the voltage connection and the length of the pipeline, of the road and of the power line. These functions are valid for SSHP with flow values of less than 10 m³/s. These costs include labour and mounting costs of all the equipment.

Each component of the hydropower plant has its own worksheet in the workbook, with the structure shown in Figure 3.1.5.2.

Storrena INTAKE DAM							
$K_{rd} = 0,035$		$Q < 0,1$		[mill. NOK](1)			
$K_{rd} = -0,1111 \cdot Q^2 + 0,3222 \cdot Q - 0,0111$		$0,1 < Q < 1$		[mill. NOK](2)			
$K_{rd} = -0,00001 \cdot Q^3 - 0,0012 \cdot Q^2 + 0,0772 \cdot Q + 0,2049$		$1 < Q < 10$		[mill. NOK](3)			
$K = a_3 \cdot Q^3 + a_2 \cdot Q^2 + a_1 \cdot Q + a_0$							
Equation	Limits of flow validity [m ³ /s]		COEFFICIENTS				Cost [mill. NOK]
			a ₃	a ₂	a ₁	a ₀	
1	0	0,1				0,03500	
2	0,1	1		-0,1111	0,3222	-0,0111	0,04330
3	1	10	-0,00001	-0,0012	0,0772	0,2049	0,21876
<p>Q 0,18 m³/s If Q>10 equation with higher rank is used</p> <p>$K_{intakedam}$ 2000 43 296 NOK</p> <p>Price increase 0,40</p> <p>Updated cost 80 615 NOK</p> <p>COST 60 615 MU</p>							

Figure 3.1.5.2: Overview of one of the HHP plant components

Intake dam

The intake dam cost is dependent on flow. It includes the cost of a coarse synthetic trash rack at the chamber entrance and a shutting mechanism. Discrepancies have arisen among SHPP consultant companies as the cost is dependent on the morphology of the river, the width and height of the river, the shape of the valley and soil foundations.

Dam gate

The cost function of the dam gate depends on its cross-sectional area, considering a maximum water velocity of 0,5 m/s. Different types of gates are possible depending on the flow rate. Stoplog gates are used for flows less than 1 m³/s, slide gates for Q<2 m³/s and roller gates for Q>2 m³/s.

Intake gate or valve

The cost of the valve at the penstock intake is dependent on the inner diameter of the pipe. It includes the cost of the air inlet valve. The type of valve considered in the NVE costs estimates is a butterfly valve. The cost of the intake gate is a function of the area. Types of intake gate are stoplog, slide gate and roller gate.

Trash rack

The cost function of the trash rack is dependent on its cross-sectional area. The trash rack has a fine grid and is located at the intake of the penstock. The material considered in the NVE cost functions is synthetic material.

Pipes

The cost of the pipes depends on the inner diameter. Material and location of the pipes also impact the cost. Possible pipe materials from the NVE cost functions are GRP, PE, ductile cast iron and stainless steel. They can be buried, in the earth or mountain

in ditches Figure 3.1.5.3, or mounted externally on the surface. On external pipes, it is assumed that there is 60 m between the anchor blocks and 9 m between support blocks. The cost of the trench depends on the type of terrain, on the width of the trench bottom (1 or 2 m) and on the depth of the trench. The depth of the trench is determined by the diameter of the pipe. When the diameter is less than 1 m, the depth is 2 m, otherwise it is 3 m. The cost function includes the costs for digging, blasting and backfilling the pipeline.

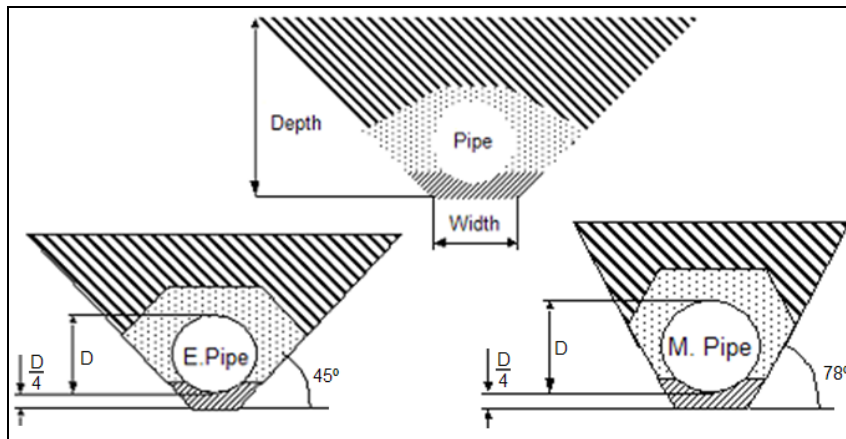

Figure 3.1.5.3: Pipes buried in the earth, E, or in the mountain, M. (MGK, 2000)

Powerhouse

The cost function depends on the design flow. For flows less than 0,1 m³/s, this formula is not valid and it must be estimated using other methods. Small-scale SHPPs are built outdoors and not underground.

The power variable to introduce on each cost function depends on the component. The efficiencies considered for the power variable correspond at the maximum flow available, discussed in Table 2.3. The efficiency of the transformer is assumed 100%.

$$P = \rho \cdot g \cdot Q \cdot H_n$$

$$P = \rho \cdot g \cdot Q \cdot H_n \cdot \eta_{\text{turbine}}$$

$$P = \rho \cdot g \cdot Q \cdot H_n \cdot \eta_{\text{turbine}} \cdot \eta_{\text{generator}}$$

$$P = \rho \cdot g \cdot Q \cdot H_n \cdot \eta_{\text{turbine}} \cdot \eta_{\text{generator}} \cdot \eta_{\text{transformer}}$$

Turbine

The turbine cost depends on the type of turbine, the flow and the head. The valid equation is the one with $H < x$, where x is the height limit of the cost functions. The turbine has a synchronous speed or a value very close to it.

For $P < 500$ kW the cost function of the turbine actually includes the cost of the turbine, turbine regulation, inlet valve, generator, switchgear, controller and transformer. For $P > 500$ kW the cost function includes the turbine, turbine regulation and the inlet valve.

Generator

The cost of the generator depends on the power output; air-cooled generators are assumed.

Crane

The cost of the crane depends on the type of turbine and on the power output. The weight, W , of the turbine-generator dictates the crane type. Simple chain hoist cranes are used for weight less than 1000 kg, electric hoist with electrical traverse carriage and chain are used for $W < 3000$ kg or electric hoist with electrical traverse carriage and wire is required for $W < 10000$ kg.

Transformer

The transformer transforms the voltage up to 22 kV to adapt the SHPP to the voltage level of the distribution grid. The cost of the transformer depends on the power output. The cost of a house transformer, which supplies the station with electricity at a voltage level of 230/400V must be included. The cost of the house transformer is around 40000 NOK.

Controller

The cost of the controller depends on the power output. This cost consists of the assemblies control, generator protection, control operation, water level regulation, SCADA (remote control) and batteries.

Switchgear

The cost of the switchgear depends on the power.

Power cable

The station can transmit the electricity with a high (22 kV) or low voltage (<1100 V) cable. The cost depends on the distance to the connection point and on the voltage level of the cable. For connections with low voltage cable, the cost depends on the current. To determine the voltage of the cable, two criteria can be applied; and the voltage with the lowest current should be selected. On one hand, the distance from the power plant to the network or consumers will determine the voltage. If the distance is less than 500 m, the voltage is 230 V while if it is larger, the voltage is 1000 V. On the other hand, voltage depends on the power output of the generator (Table 3.1.5.1).

Table 3.1.5.1: Voltage of the generator depending on the power (Gauldal Consult, 2008)

Power output [kW]	Voltage [V]
$P < 1500$	400
$1500 < P < 2500$	690
$P > 2500$	1000

For connections with a high voltage cable the cost is set at 450 NOK/m (250 NOK/m for the cable and 200 NOK/m for the ditch).

Access Road

The cost of the road is directly proportional to its length. It depends on the topography and on the quality of the terrain. The terrain can be classified as easy (flat), moderate or difficult (very steep). Without a field survey, it is difficult to categorize the terrain, but this classification is based on the steepness of the slope and on the existence of large rocks that are difficult to remove. The NVE road cost function considers a standard category of forest Class 3.

3.1.5.1.2 Variables of the programs

The definitions of the variables common to the programs are explained below.

Quantitative variables (text boxes)

- Flow [m^3/s]: Maximum flow
- Gross Head [m]: Difference in level between the intake and the station
- Speed of the turbine [rpm]: Synchronous or asynchronous rotational speed
- Pipe length [m]: Length of the pipeline.
- Inner diameter of the pipe [m]: Optimum diameter of the pipe which is the theoretical value that does not necessarily correspond with the standard dimensions.
- Friction factor [-]: A default value is given depending on the material chosen; but it can be modified.
- Road length [m]: Sum of the distance from an existing road to the intake and to the station.
- Bridge length [m]: A width of 3m is assumed.
- Distance to the grid [m]: Is the distance from the station to the connection point.
- Exchange rate: Is the exchange rate corresponding to 1 monetary unit (MU) to X NOK. There is a worksheet with the mean values of 2008 from European Central Bank (ECB). The exchange rates can be directly input in the worksheet. The default value is 1; in this case, MU corresponds to NOK.

Qualitative variables (list boxes)

- Pipe material: PE, GRP, ductile cast-iron and stainless steel.
- Intake: Valve or a gate
- Pipes disposal: Pipes buried in the ground or mounted on the surface. If they are buried, the cost depends on the type of soil, earth or mountain.
- Width of the trench: Width of the bottom 1 or 2 m.
- Terrain of road: Easy, moderate or difficult.
- Connection to the grid with a cable of: High or low voltage cable.

An explanation of the main tasks of the three different programs is given in the following sections.

3.1.5.2 SHP Global view, user manual

This version offers a general overview of the hydropower plant cost. The technical information of the SHPP is introduced at the “Input Data” page (Figure 3.1.5.4).

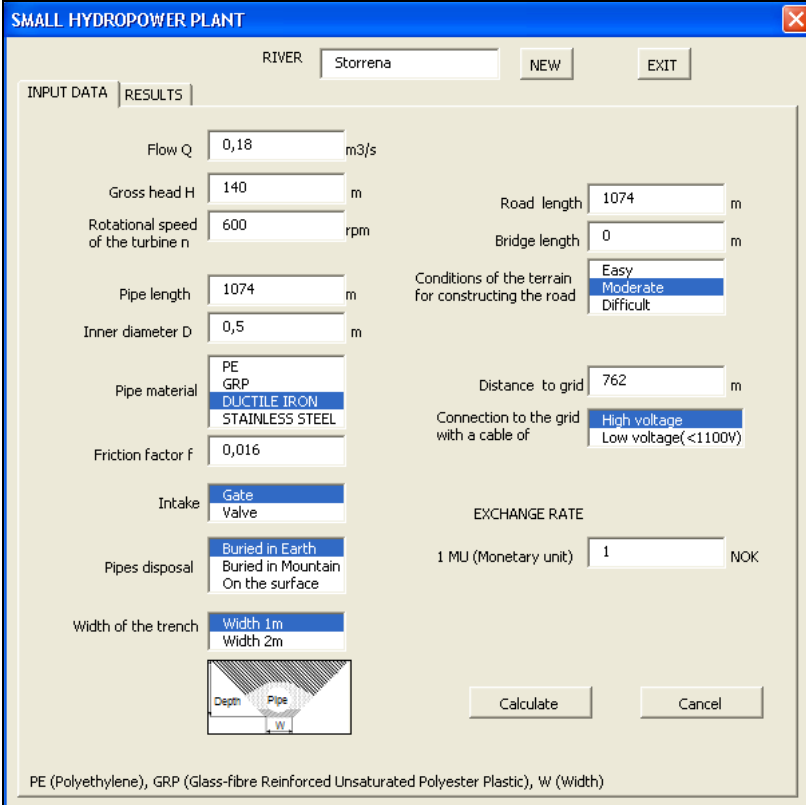

Figure 3.1.5.4: Input data page in the userform. This appears when the user press the “run small hydro power plants program” button.

This macro calculates the SHPP investment cost, given the flow, the gross head, the rotational speed of the turbine, the length and inner diameter of the pipe are not zero and one option of each listbox is selected.

The results are the cost of the components of the hydropower plant and some data of interest such as the power output, head losses, the speed number, the type of turbine and the nominal diameter. The nominal diameter displayed is a standard value equal or higher than the input value.

SMALL HYDROPOWER PLANT

RIVER:

INPUT DATA | RESULTS

Storrena COSTS

Intake dam	<input type="text" value="60 615"/>	MU	Nominal diameter	<input type="text" value="0,500"/>	m
Dam gate	<input type="text" value="5 400"/>	MU	Type of turbine	<input type="text" value="PELTON"/>	
Trash rack	<input type="text" value="3 999"/>	MU	Speed number	<input type="text" value="0,07"/>	
Intake gate or valve	<input type="text" value="5 750"/>	MU	$\Omega = \frac{\omega \cdot \sqrt{Q}}{g}$		
Pipe disposal	<input type="text" value="1 010 419"/>	MU	Power Output	<input type="text" value="213,35"/>	kW
Pipe material	<input type="text" value="1 044 535"/>	MU	Head losses	<input type="text" value="1,47"/>	m
Powerhouse	<input type="text" value="142 250"/>	MU			
Turbine	<input type="text" value="1 326 920"/>	MU	TOTAL COSTS	<input type="text" value="4 651 887"/>	MU
Generator	<input type="text" value="0"/>	MU			
Crane	<input type="text" value="11 000"/>	MU			
Transformer	<input type="text" value="0"/>	MU			
Controller	<input type="text" value="0"/>	MU			
Switchgear	<input type="text" value="0"/>	MU			
Power cable	<input type="text" value="342 900"/>	MU			
Access road	<input type="text" value="698 100"/>	MU			

Figure 3.1.5.5: Results page in the userform

3.1.5.3 SHP Individual view: cost of each component, user manual

This version is able to calculate the cost of each component independently from the other units of the SHPP. It has the advantage of not requiring all of the technical information for the entire power plant but just the ones necessary for the specific cost function requested. Each component has its own page in the multipage user form.

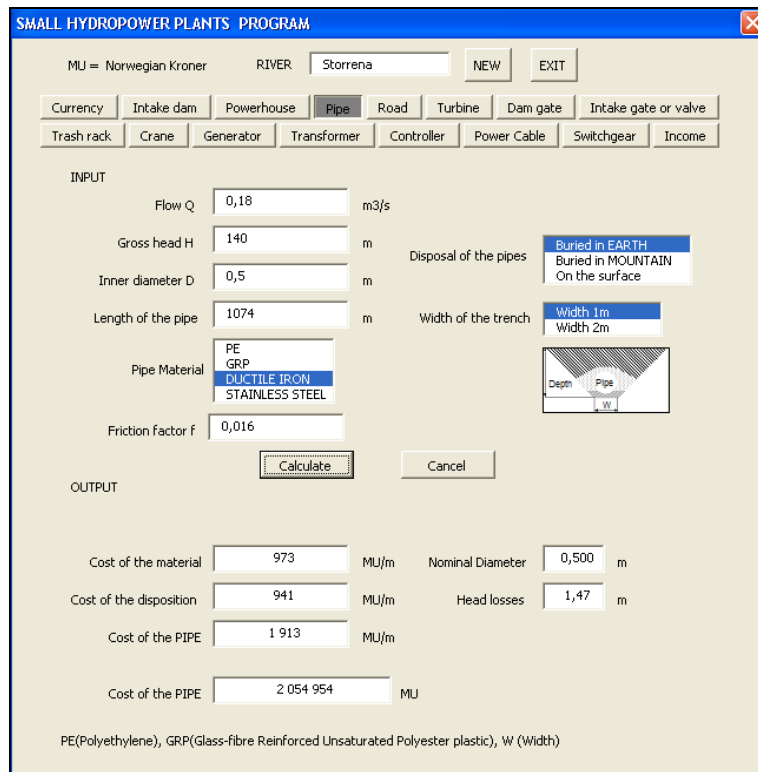

SMALL HYDROPOWER PLANTS PROGRAM

MU = Norwegian Kroner RIVER: Storrena NEW EXIT

Intake dam Powerhouse **Pipe** Road Turbine Dam gate Intake gate or valve

Trash rack Crane Generator Transformer Controller Power Cable Switchgear Income

INPUT

Flow Q: 0,18 m3/s

Gross head H: 140 m

Inner diameter D: 0,5 m

Length of the pipe: 1074 m

Disposal of the pipes: Buried in EARTH, Buried in MOUNTAIN, On the surface

Width of the trench: Width 1m, Width 2m

Pipe Material: PE, GRP, **DUCTILE IRON**, STAINLESS STEEL

Friction factor f: 0,016

Calculate Cancel

OUTPUT

Cost of the material: 973 MU/m Nominal Diameter: 0,500 m

Cost of the disposition: 941 MU/m Head losses: 1,47 m

Cost of the PIPE: 1 913 MU/m

Cost of the PIPE: 2 054 954 MU

PE(Polyethylene), GRP(Glass-fibre Reinforced Unsaturated Polyester plastic), W (Width)

Figure 3.1.5.6: Pipe page in the multipage userform.

The “SHP Individual view” calculates the income of the SHPP (MGK report, 2000):

$$Income = (Annual\ production - Self\ Consumption) \cdot spot\ price + Self\ Consumption \cdot Energy\ price\ for\ Self\ Consumptions$$

The first term of the equation corresponds to the energy sold and the second term is the money that the owner of the SHPP has saved by not purchasing electricity from the grid company. Locally, in Sør-Trøndelag, the average spot price is 400 NOK/MWh (Nord Pool, 2008). The price that the consumers pay for the energy consists on the one hand of the spot price and on the other hand of a grid fee, user fee, an annual fixed subscription cost and environmental taxes. The self consumption energy is the energy consumed by the owner of the SHPP, for example, for farming. The default scenario considers no self-consumption energy.

There is a page where the currency can be selected from a list. If the desired currency is not on the list, the exchange rate may be introduced manually. The exchange rate

that appears corresponds to the mean value from the ECB 2008, but it is possible to update it manually.

3.1.5.4 SHP optimisation program, user manual

This program optimises the SHPP by minimizing the capital cost and maximizing the energy output. Most of the results of the work in the Smart pilot region are obtained using this optimisation program.

It can automatically select the adequate components for the operation range with lower prices, such as the intake, gate or valve, or the pipe material considering tolerable head losses. The turbine chosen for every river is the one with highest energy output and lowest cost.

	A	B	C	D	E	F
1	INPUT DATA					
2	Name of the river	Søndre Tverråa				
3	Drainage Area	10,20	km ²			
4	Runoff	1176,50	mm/year			
5	Gross Head	116	m			
6						
7	Pipeline lenght horizontal (Xmap)	818,48	m			
8						
9	Road length to intake	0	m			
10	Road Length to plant station	0	m			
11	Bridge Length	0	m			
12						
13	Powerline Lenght to the grid	570,54	m			
14	Connection to grid	22	22 if 22 kV or 230 if connected to low voltage			
15						
16	Intake level	603	m			
17	Plant station level	487	m			
18	Location	SE				
19						
20	Available percentage of the flow (m	50	%			
21	Spot price	0,4	NOK/kWh			
22	Interest Rate	5,8	%			
23	Compensation flow	0,016144398	m ³ /s			
24	Taxes	28	%			
25	Optimum flow: percentage of the r	120	%			
26						

Figure 3.1.5.7: “Input” worksheet

The main characteristics of the SHPP have to be introduced in the “Input” worksheet. Initially, the optimum intake and station level are unknown and many parameters will change according to these locations. These parameters include the catchment area, runoff, gross head and lengths of the pipeline, access road and power cable. Finding the best location is a matter of performing several iterations.

The terrain conditions and the pipes disposal are default values for the optimisation program: Moderate quality is considered for the road terrain conditions and the pipes are assumed to be buried in earth, with a width of 1 m in the bottom of the trench. The

SHPP is connected with a power cable to the existing local 22 kV distribution grid rather than supplying the energy directly to consumers. If it is connected to a low voltage grid, the cable can be of low voltage, otherwise, high voltage cable is preferred as they experience fewer losses.

The SHP optimisation program is suitable for ungauged sites; the mean annual flow is scaled using runoff data from a metering station. However, it is also suitable for gauged rivers, if the flow is entered directly into the corresponding cell. In the current version of the program it is inserted the runoff data from a metering station called Eggefoss in the Norwegian smart pilot region. If the available runoff recorded is from a metering station other than Eggafoss, it can be replaced into the corresponding cells at the worksheet.



Figure 3.1.5.8: Press this button in the worksheet “Runoff data”, to generate the durability curve from the runoff data.

The runoff data is sorted to obtain the flow duration curve by pressing the “Sort 30 FDC Data” command button (Figure 3.1.5.8). The average daily energy and power output is calculated and it will help to select the optimum turbine.

All the costs are calculated with the maximum flow available and with the corresponding efficiencies at this flow. The power inserted into the functions depends on each component.

The cheapest appropriate intake apparatus, either a gate or a valve, is selected automatically.

The choice of turbine is a balance of high energy output and low cost. If these criteria do not converge the message “Consider” appears. In this case, the turbine with lowest scope [NOK/kWh] can be selected manually, discussed in the coming section Components selection.

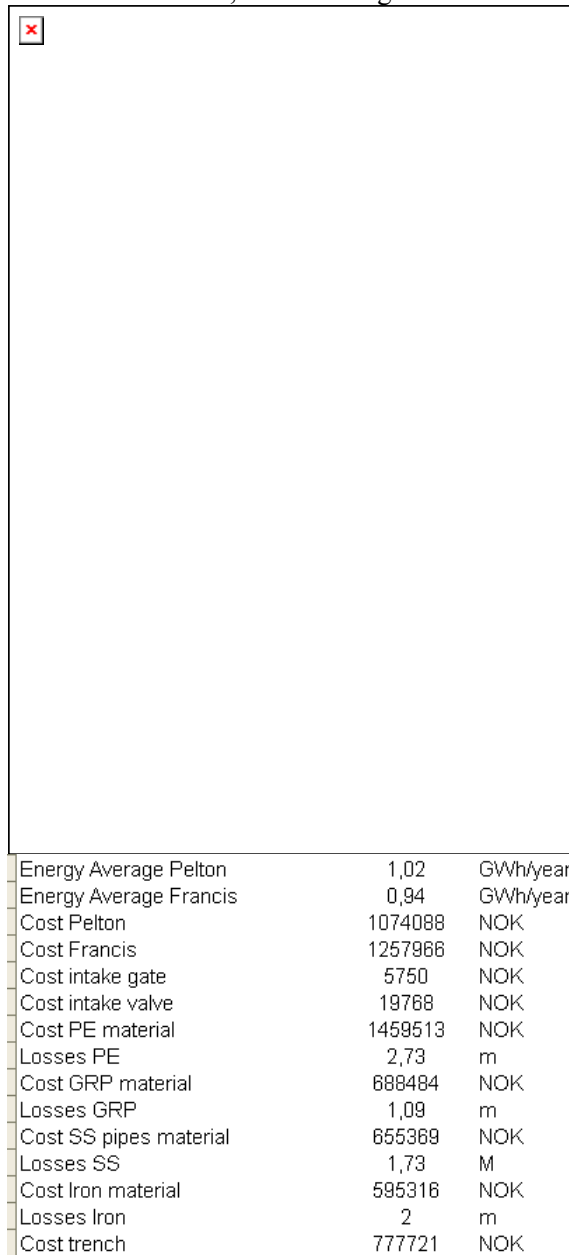

Figure 3.1.5.9: Press this button in the worksheet “Pipes”, to calculate the optimum diameter of the pipes.

The macro “Optimum diameter” optimises the pipe diameter of each material according to the head losses and the cost of the material (Figure 3.1.5.9). This macro, sets the manually derived total cost equation to zero. To calculate the optimum diameter, a pressure class that corresponds to an average pressure class higher than the static head is assumed along the pipeline. In reality, there are different pressure classes in the penstock, with higher pressure classes at the power station and lower classes at the intake. The pipe material selected is the cheapest, which does not necessarily correspond to the most suitable material to the terrain. In order to make a final decision, a field survey is necessary.

After having gone through the previous mentioned steps the user can go into the “Result” worksheet, shown in Figure 3.1.5.10:



Energy Average Pelton	1,02	GWh/year
Energy Average Francis	0,94	GWh/year
Cost Pelton	1074088	NOK
Cost Francis	1257966	NOK
Cost intake gate	5750	NOK
Cost intake valve	19768	NOK
Cost PE material	1459513	NOK
Losses PE	2,73	m
Cost GRP material	688484	NOK
Losses GRP	1,09	m
Cost SS pipes material	655369	NOK
Losses SS	1,73	M
Cost Iron material	595316	NOK
Losses Iron	2	m
Cost trench	777721	NOK

Figure 3.1.5.10: “Result” worksheet showing the generated results.

The “Results” worksheet provides the cost of every component and other data of interest such as the maximum flow, the net head, the power output, the pipe material and diameter, type of turbine and intake. The energy output and cost of a Pelton and a Francis turbine, the cost of different intake components and of different pipe materials and head losses are also presented.

In the worksheet “Total costs” the user can see graphically how the SHP costs are distributed, as shown in Figure 3.1.5.11.

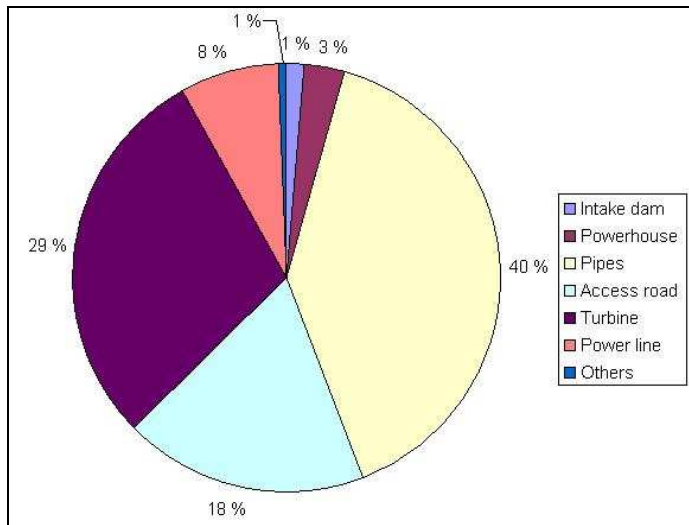

Figure 3.1.5.11: Cut out from the “Total costs” worksheet.

The worksheet “Economic” contains an economic analysis of the project. There are different parameters available to evaluate the feasibility of a project. In the worksheet “Economy” the user can have a look at the payback period (PB), the scope in NOK/kWh, the benefit/cost ratio, the net present value (NPV) and the internal rate of return (IRR). To have a general economic picture of the project it is important not to rely upon a single parameter, but to consider them all.

The analysis is based mainly on the following economic parameters:

The planning horizon, or observed lifetime, is set to 30 years with annual periods. The budget of treasury is a forecast of future payments and incomes during the horizon.

The initial investment costs consist of the SHPP component cost with an additional 10 % for contingencies and another 10 % added for the project management costs (engineering and administration)

The annual costs for the SHPP include operation and maintenance costs, taxes, amortization and interest on capital. Operation and maintenance costs are 20 NOK/MWh for installations less than 1 MW, and for installations of greater than 1 MW are 40 NOK/MWh. The interest rate, or the time value of capital is, 5,8 %. The cash flow is converted to present-values with a fixed discount rate.

The income for a SHPP results from the sale of generated electricity. The average annual energy output and the spot price 400 NOK/MWh are considered to be constant through the horizon. It is a conservative assumption, but prices are constantly changing and predictions are uncertain, especially with the financial crisis at the time this was written.

Civil works have typically an asset life of about 40-60 years, electro-mechanical equipment about 25-35 years and transmission equipment 20-35 years (Goldsmith, 1993). A global average asset life for the SSHPP is assumed to be 30 years. The amortization is the systematic annual depreciation occurred for its application to the productive process.

The taxes applied are 28 %.

Economic Analysis				
Design power output	0,17311	MW		
Energy output average	1016,40	MWh		
Electricity price	0,4	NOK/kWh		
Interest Rate	0,058			
Taxes	0,28			
Period of analysis(N)	30	years		
Asset lives	Assumption as costs	Amortization	Residual values	
Civil work	50	1572208	31444	628883
Electro mechanical pe	30	1100188	36673	0
Transmission equipm	28	0	0	0
Lines and cables	33	256743	7900	19749
		amortization/y	76017	648632 total
Cost	2929139	NOK		
Contingencies	292914	NOK	***Contingencies and management are 10%of the cost of the components	
Project management	292914	NOK		
Total investment	3514967	NOK		
Amortization in	30 years		97638,0	
M&O (Maintenance a	20	NOK/MWh	20328	NOK
Scope	3,46	***Should be to be feasible between 3 and 4		
Price	0,4	NOK/kWh	***Change price in the worksheet of PIPE	

Figure 3.1.5.12: Cut out from the “Economic” worksheet.

Like shown in Figure 3.1.5.12 comments are shown in the worksheets where guidance of the user might be necessary. The assumptions that are made through the work with the norwegian SMART pilot region can also easily be changed.

3.1.6 References

Books

BELDRING S., ANDRÉASSON J., BERGSTROM S., ENGEN-SKAUKEN T., *Hydrological climate change maps of Nordic countries based on RegClim HIRHAM and Rossby Centre RCAO regional climate model results*. NVE, 2006.

BOIX E., SAINZ L., CÓRCOLES F., SUELVES FJ., *Tecnología eléctrica*. Ceysa, Editorial Técnica, Barcelona, 2004.

DAVIDSON J., REED W., DAVIS P., *Exploring Earth- An Introduction to Physical Geology*, Prentice Hall Upper Saddle River, NJ 07456, 2002.

GOLDSMITH, K. *Economic and Financial Analysis of Hydropower Projects*. Trondheim: NTNU Hydropower development 6, 1993.

GULLIVER J., ARNDT R., *Hydropower Engineering Handbook*. United States: McGraw-Hill, Inc, 1991.

HAYWARD, A., *Flowmeters. A basic guide and source-book for users*. London: The Macmillan press LTD, 1979.

HELLAND-HANSEN E., HOLTEDAHL T., ARNSTEIN K., *Environmental Effects*. Trondheim: NTNU Hydropower development 3, 1995.

HVEDING V., *Hydropower development in Norway*. Trondheim: NTNU Hydropower development 1, 1992.

INVERSIN A., *MICRO-HYDROPOWER SOURCEBOOK A practical guide to design and implementation in developing countries*. Washington, D.C: NRECA International Foundation, 1986

KILLINGTVEIT Å., ROAR N. *Hydrology*. Trondheim: NTNU Hydropower development 7, 1995

KJØLLE, A. *Hydropower in Norway. Mechanical Equipment*. NTNU, 2001

LYSNE, D., GLOVER B., STØLE H., TESAKER E. *Hydraulic Design*. Trondheim: NTNU Hydropower development 8, 2003

NIELSEN T., *Dynamic dimensioning of hydropower plants*. Compendium NTNU, 2008

VINOOG, L., ELSTAD, I., *Mechanical Equipment*. Trondheim: NTNU Hydropower development 12, 2003

VOKSØ A., KAVLI O., STENSBY H. *Bruk av GIS til beregning av potensial for små kraftverk i Norge* NVE, GEODATA 2005.

WESTGAARD, E., ENGER, A.K., MELLBYE H.J., SONSTAD J., TORKILDSEN Ø., VIKANES S., *Electrical Equipment*. Trondheim: NTNU Hydropower development 13, 1994

Electronical sources

ACIA *Arctic Climate Impact Assessment*. Cambridge University Press, 2005. Available [online] : <http://www.amap.no/acia/>

ALFSEN K., SKODVIN T., *The Intergovernmental Panel on Climate Change (IPCC) and scientific consensus. How scientists come to say what they say about climate change*. Available [online]: <http://www.cicero.uio.no/media/49.pdf> Centre for International Climate and Environmental Research-Oslo CICERO, 2004

ALTINBILEK, DOGAN, SEELOS, KARIN, TAYLOR, RICHARD. *Hydropower's role in delivering sustainability* Available [online]: http://www.engineeringvillage2.org/controller/servlet/Controller?EISESSION=1_caf6c11217fb3240fMe89ses4&CID=quickSearch&database=2105351

BAKIS, R., *The current status and future opportunities of Hydroelectricity*. Taylor&Francis 2007 Available [online]: http://www.engineeringvillage2.org/controller/servlet/Controller?EISESSION=1_caf6c11217fb3240fMe89ses4&CID=quickSearch&database=2105351

BARCELONA FIELD STUDIES CENTRE. *Method of measuring river discharge from Barcelona Field Studies Centre*. Available [online]: <http://geographyfieldwork.com/River%20Discharge%20Methodology.htm>

B.O.E Num 150 MINISTERIO DE OBRAS PÚBLICAS, *Instrucción 3.1-IC "Características geométricas. Trazado"* (in Spanish) [online], 2000 Available [online]: <http://www.carreteros.org>

DEMIRBAS, A., *Focus on the World: Status and Future of Hydropower*. Taylor&Francis. Available [online]: http://www.engineeringvillage2.org/controller/servlet/Controller?EISESSION=1_caf6c11217fb3240fMe89ses4&CID=quickSearch&database=2105351

ESHA EUROPEAN SMALL HYDROPOWER ASSOCIATION., *Guide on How to Develop a Small Hydropower Plant*, 2004. Available [online]: http://www.esha.be/fileadmin/esha_files/documents/publications/publications/Part_1_Guide_on_how_to_develop_a_small_hydropower_plant- Final.pdf Accessed [16/5/09]

IEA, INTERNATIONAL ENERGY AGENCY. *Key world statistics 2008* [online]. Available from: http://www.iea.org/textbase/nppdf/free/2008/key_stats_2008.pdf Accessed [5/5/09]

MGK MIDTRE GAULDAL KOMMUNE REPORT, *Miljøtilpasset El-Kraftproduksjon Ved Små vannkraftverk i distrikts-norge* [online]. Contributors:

NTNU (Waterpower laboratory, Centre for Rural Research), Norwegian Agricultural Economics Research Institute and Gauldal Energi. Available [online]:
http://www.rennebu.kommune.no/data/miljotilp_elprod_vedlegg.pdf

NORCONSULT/NVE, *Veileder i planlegging, bygging og drift av små kraftverk*, Norges vassdrags- og energi direktorat, 2003. Available [online]:
http://195.18.194.201/PageFiles/1621/Veileder_smaa_vassdragstiltak_1-08.pdf

NORD POOL, *Nordic power market*. Available [online]:
<http://www.nordpoolspot.com/PowerMaket/> Accessed [5/5/09]

NVE, *Handling Procedures*. Available [online]:
<http://www.nve.no/en/Licensing/Handling-prosedures/>

POLYZAKIS, A.L., KORONEOS C. *Optimum gas turbine cycle for combined cycle power plant*. 2007 Available [online] Science Direct:
http://www.sciencedirect.com/science?_ob=ArticleURL&_udi=B6V2P-4PT1P00-2&_user=586462&_rdoc=1&_fmt=&_orig=search&_sort=d&_view=c&_acct=C000030078&_version=1&_urlVersion=0&_userid=586462&md5=ec144f7ead34a0ff164219e386aee9f4

SØR-TRONDELAG FYLKESKOMMUNE, *Foreløpig-Faktaark-MIKRAST-Miljøvennlige kraftverk i Sør- Trøndelag*, [online]. 28/7/2006 Available from:
[www.fylkesmannen.no/Faktaark Søndre Tverraa-B Ee6VT968504-B.pdf.file](http://www.fylkesmannen.no/Faktaark_Søndre_Tverraa-B_Ee6VT968504-B.pdf.file)

STATNETT, *The power grid system*, Available [online]:
<http://www.statnett.no/en/The-power-system/About-the-power-system/The-power-grid/> Accessed [5/5/09]

SYGNA, L., ERIKSEN S., O'BRIEN K., OTTO L., *Climate change in Norway: Analysis of economic and social impacts and adaptations*. Available [online]:
<http://www.cicero.uio.no/media/3290.pdf> Centre for International Climate and Environmental Research-Oslo CICERO, Oslo 2004

Runoff data from NVE Atlas, Available [online]:
<http://arcus.nve.no/website/nve/viewer.htm>

UN UNITED NATIONS. *Report of the World Commission on Environment and Development* (11/12/1987). Available [online]:
<http://www.un.org/documents/ga/res/42/ares42-187.htm>

Master thesis

BØCKMAN T., JULIUSSEN E., *Investering i småkraftverk under usikkerhet*. Master thesis, NTNU. Trondheim Juni 2005

MALMBECK M., *Potensialet for minikraftverk I deler av det vernede Gaula-vassdraget*. Master thesis. IVB, NTNU 2000

Lecture notes



DAHLHAUG, O. G *Lecture notes on technical and economic analysis in hydropower planning*, NTNU 2008

DAHLHAUG, O. G., *Lecture notes on Pipes in Hydropower plants*, NTNU 2008

DAHLHAUG, O. G., *Lecture notes on Trashrack*, NTNU 2008

SMART
Strategies to Promote Small Scale
Hydro Electricity Production In Europe

WP 3 – Deliverable D3.1
Policies, methodologies & tools that may support decision makers in
implementing Small Scale Hydro Electricity Plants

**Guidelines and Tools for a
Technical and Economic Evaluation of
Small Hydro Electricity Plants construction**

Chapter 3.2 FBUZ & Karlovac county, Croatia





Policies, Methodologies & Tools to Improve the Exploitation of SHP 3.2 FBUZ, & Karlovac County Croatia

Table of contents

Summary-----	4
3.2.1 Introduction to Base Costs Estimate and Financial Analysis -----	5
3.2.2. Capital (investment) costs-----	9
3.2.2.1. Costs of civil works-----	9
3.2.2.2. Costs of hydro-mechanical and electro-mechanical equipment-----	10
3.2.2.3. Cost of grid connection (power transmission line)-----	11
3.2.2.4. Other indirect costs-----	11
3.2.3. Annual costs -----	13
3.2.3.1. Depreciation of equipment-----	13
3.2.3.2. Operation and Maintenance (O&M) costs -----	13
3.2.3.3. Replacement and renovation costs -----	14
3.2.3.4. Pumping costs -----	15
3.2.4. Income and benefits-----	15
3.2.5. Financial analysis-----	15
3.2.5.1. Financial mathematics-----	15
3.2.5.2. Methods of economic evaluation-----	18
3.2.5.3. Tariffs and incentives-----	22
3.2.5.4. Revenue assessment - analysis of the financial behaviour of a small hydro power plant-----	23
3.2.5.5. Financing strategy-----	26
3.2.5.6. Cash flow analysis and implementation schedule-----	26
3.2.5.7. Unit cost of energy-----	27
3.2.5.8. Sensitivity and risk analysis-----	27
3.2.5.9. Economic life-----	28
3.2.5.10. Criteria for decision-----	28
3.2.6. Implementation and development of a small hydro power plant-----	28
3.2.6.1. Contract packaging models-----	29
3.2.6.2. Contract delivery models-----	29
3.2.6.3. Financing schemes-----	30
3.2.7 DESCRIPTION of RETScreen® users' software-----	32
3.2.7.1 Hydrology-----	34
3.2.7.1.1 Flow-duration curve-----	35
3.2.7.1.2 Available flow-----	35
3.2.7.1.3 Firm flow-----	36
3.2.7.2 Load-----	36
3.2.7.2.1 Energy demand-----	36
3.2.7.2.2 Average load factor-----	37
3.2.7.3 Energy Production-----	37
3.2.7.3.1 Turbine efficiency curve-----	37
3.2.7.3.2 Power available as a function of flow-----	39
3.2.7.3.3 Plant capacity-----	39
3.2.7.3.4 Power-duration curve-----	39
3.2.7.3.5 Renewable energy available-----	40
3.2.7.3.6 Renewable energy delivered - central-grid-----	40
3.2.7.3.7 Renewable energy delivered - isolated-grid and off-grid-----	40
3.2.7.3.8 Small hydro plant capacity factor-----	42
3.2.7.3.9 Excess renewable energy available-----	43
3.2.7.4 Project Costing-----	43
3.2.7.5 Validation-----	43



**Policies, Methodologies & Tools to
Improve the Exploitation of SHP
3.2 FBUZ, & Karlovac County Croatia**

3.2.7.5.1 Turbine efficiency -----	43
3.2.7.5.2 Plant capacity and annual renewable energy delivered -----	45
3.2.7.5.3 Project costs -----	46
3.2.8. References-----	49
APPENDIX A: Example: The investment is not externally financed-----	50
APPENDIX B: Example: The investment is externally financed-----	54
APPENDIX C: FINANCIAL ANALYSIS -----	56
APPENDIX D: TURBINE EFFICIENCY FORMULAE -----	57
APPENDIX E: FORMULAE FOR FORMULA COSTING METHOD-----	62



Summary

Chapter 3.2 is the croatian contribution of deliverable D3.1 of the European Project named SMART. It contains guidelines and tools for a technical and economic evaluation of SHP construction.

Chapter 3.2.7- 3.2.6 gives general guidance to financial analysis of small hydro power plants, while chapter 3.2.7 presents the software tool for planning of SHP, developed at FBUZ in order to simplify the task of discovering potential profitable SHP projects.

The program tools have been tested on the pilot region and the results are presented in deliverable D4.1 in work package 4 of the SMART project.

3.2.1 Introduction to Base Costs Estimate and Financial Analysis

Cost estimates for small hydroelectric projects (SHP) are generally similar to those for other types of projects. However, there are some special considerations, particularly with respect to sources of data.

The costs of the project are divided into two categories: capital (investment) and annual costs. Capital costs include civil costs, electro-mechanical equipment, power transmission line, and other indirect costs. Annual costs include the depreciation of equipment, operating and maintenance (O&M), and replacement costs. The income of the project is based solely on the sale of electrical energy.

Civil costs consist of the construction and hydro-structural costs of the project, including a reservoir dam, the water penstock structure, the power house, the tailrace structure, the access road and any future unpredicted costs taken from the preliminary designs of a feasibility study.

Electro-mechanical equipment costs include turbines, generators, governors, gates, control systems, a power substation, electrical, and mechanical auxiliary equipment, etc.

Power transmission line costs (cost of grid connection) include a power transmission line for delivering generated energy from the power plant to power transmission network. The transmission line cost depends on the location, type of existing system (overhead line or cable system), and the capacity of HPP as well as length of transmission lines, which have a very high effect on the project costs.

Indirect costs include Engineering and Design (E&D), Supervision and Administration (S&A), and inflation costs during the construction period. E&D costs are affected by many parameters, such as type, size and location where the project is being constructed. The E&D costs are usually expressed as a percentage of construction costs, including civil and equipment costs, and the amount of this percent differs from one location to another. S&A costs include the purchase of land, management, inspection and supervision costs, and other miscellaneous costs in the region. Similar to the E&D costs, the S&A costs are expressed as a percentage of the construction costs.

Inflation costs during construction are result of inflationary trends. To precisely calculate the investment cost of a project, it is necessary to take into account the inflation rate during the course of the project and adjust the investment cost with respect to the inflation rate. The inflation rate of future years should be determined by obtaining the average of previous years' inflation rate.

In addition to investment costs, annual costs should be calculated to obtain the net benefit of a project. Annual costs include depreciation of equipment, Operating and Maintenance (O&M), and replacement and renovation costs.

In the economical analysis of the project, depreciation and other factors affecting the equipment should be considered.

O&M costs include salary/wages of personnel, labor, insurance, tax, duties, landscape, and consumable materials. These costs are increased only by the annual inflation coefficient. A 5% inflation rate is used in the economical calculations. The costs which are related to the salary/wage and consumable materials make up one percent of annual investment costs, and insurance, tax, duties, charges, and unpredicted cases are also taken as one percent of annual investment costs. It should be noted that in order to calculate investment costs, the interest rate during construction should also be considered.

The main parts of the SHP, such as generator windings, turbine runners and other parts will eventually need replacement and renovation. To estimate the costs, the percentage of renovation and replacement should be determined for different sections separately.

Figure 3.2.1. presents distribution of capital (investment) costs for different number of units of SHP.

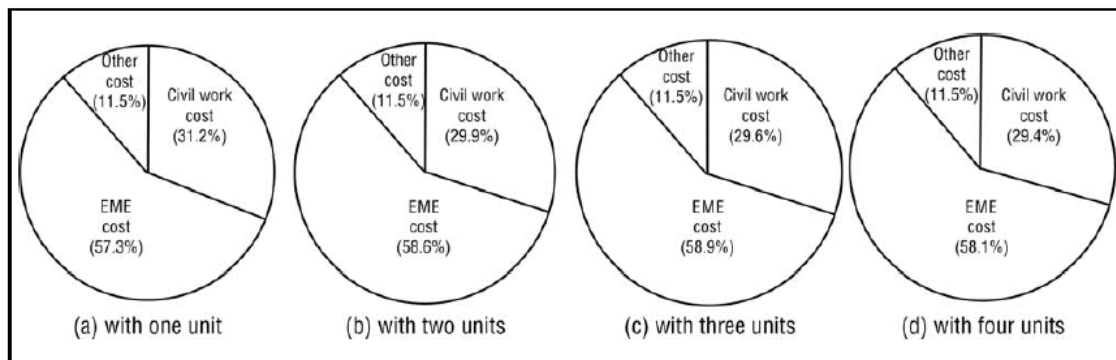

Figure 3.2.1. Distribution of capital (investment) costs for different number of units of SHP (EME – electro-mechanical equipment)

Cost estimates are made for all levels of hydropower investigations. Reconnaissance, feasibility, and project design reports each require cost estimates that are consistent with the level of detail presented in the study.

The purpose of a reconnaissance report is to determine if a project has sufficient promise to warrant more detailed study. The intent of this report is to perform a preliminary economic analysis and appraise the critical issues, rather than to formulate detailed approaches or solutions. Cost information would be obtained from generalized cost curves or from data for similar projects. The report would contain a summary cost estimate for one or more schemes, and drawings would be limited to a cross section of the powerhouse and a plan showing exterior dimensions of the structure.

The purpose of a feasibility study is to determine whether a specific project (or other action) should be recommended for authorization. At this level of study, the primary objective is to formulate a project and to establish project feasibility. As the study progresses toward selection of the recommended plan, characteristics are defined, and costs for the major electrical and mechanical items, such as turbines and generators, may be obtained directly from the manufacturers. Costs for civil features, such as powerhouse structure, penstock, and intake and outlet works, are similarly refined. In the early stages of project formulation, a large number of alternative plans may be under consideration, and cost estimates may be similar to reconnaissance grade estimates. Once the number of alternatives has been screened down to the best candidates, more detailed cost estimates are prepared. Narrative descriptions of the major elements of the powerhouse are included, together with drawings describing the general location plan, powerhouse plan and section, and a one-line diagram of the electrical system.

Definite Project Reports (DPR) is the last documents written prior to preparation of plans and specifications. At this stage of study, detailed cost estimates are based upon specific design studies for all powerhouse features.

The estimation of the investment cost constitutes the first step of an economic evaluation. For a preliminary approach, the estimation can be based on the cost of similar

schemes. IDAE (Instituto para la Diversificación y Ahorro de Energía, Spain) in its publication “Minicentrales Hidroeléctricas” analyses the cost of the different components of a scheme - weir, water intake, canal, penstock, powerhouse, turbines and generators, transformers and transmission lines. J. Fonkenelle also published monographs, but only for low-head schemes. The Departamento Nacional de Aguas e Energia Eléctrica (DNAEE) developed a computer program, FLASH, for small hydro feasibility studies. There are a number of software packages available to assist in the analysis of a potential site. PC based packages such as HydrAv and Hydrosoft^{vi} are available on the Web and can often be downloaded. Some of them are limited to particular regions or countries whilst others are more generic. The RETScreen Pre-feasibility Analysis Software^{vii} is a generic, freely available software package with an on-line user manual. It enables users to prepare a preliminary evaluation of the annual energy production, costs and financial viability of projects. Whilst identifying that the site has a technical potential is paramount, the key to any successful development is undertaking an economic analysis of a site that will provide an accurate indication of the investment cost required. During this analysis an essential consideration is the estimated cost per kW of the site.

In his communication to HIDROENERGIA'97 on the THERMIE programme, H. Pauwels from DG TREN, former DG XVII, he summarised data from schemes presented to the above programme and correlates the investment cost in €/kW installed for different power ranges and heads. Perhaps not surprisingly two characteristics become clear from this graph: costs increase as head decreases and similarly as scheme kW size decreases also. The conclusion being that small (less than 250kW), low head (less than 15m) schemes represent the highest relative costs for a scheme, Figure 3.2.2.

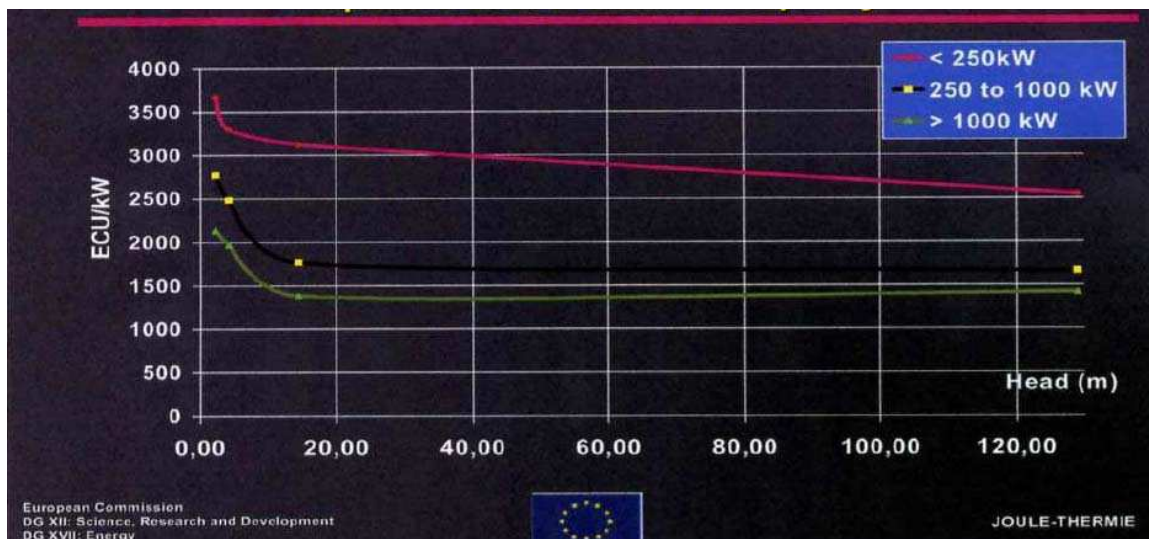

Figure 3.2.2. Specific cost of installed capacity

Also presented at HIDROENERGIA '97 from the computer program, Hydrosoft, was the set of curves in correlating the investment cost in €/kW and the installed capacity (between 100 kW and 10 MW) for low head schemes, with 2, 3, 4 and 5 m head (Figure 3.2.3.).

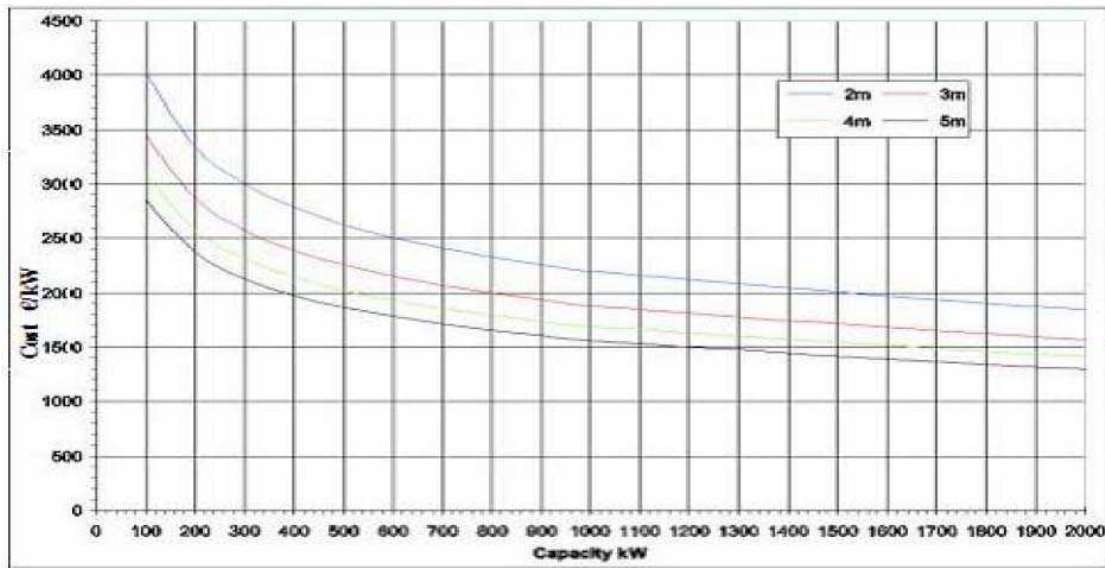

Figure 3.2.3. Investment costs for installed capacity for specific heads

More recent figures from ESTIR show investment costs specific to small hydro and scheme kW size (but does not relate to head). These costs have quite a range and are shown in Figure 3.2.4.

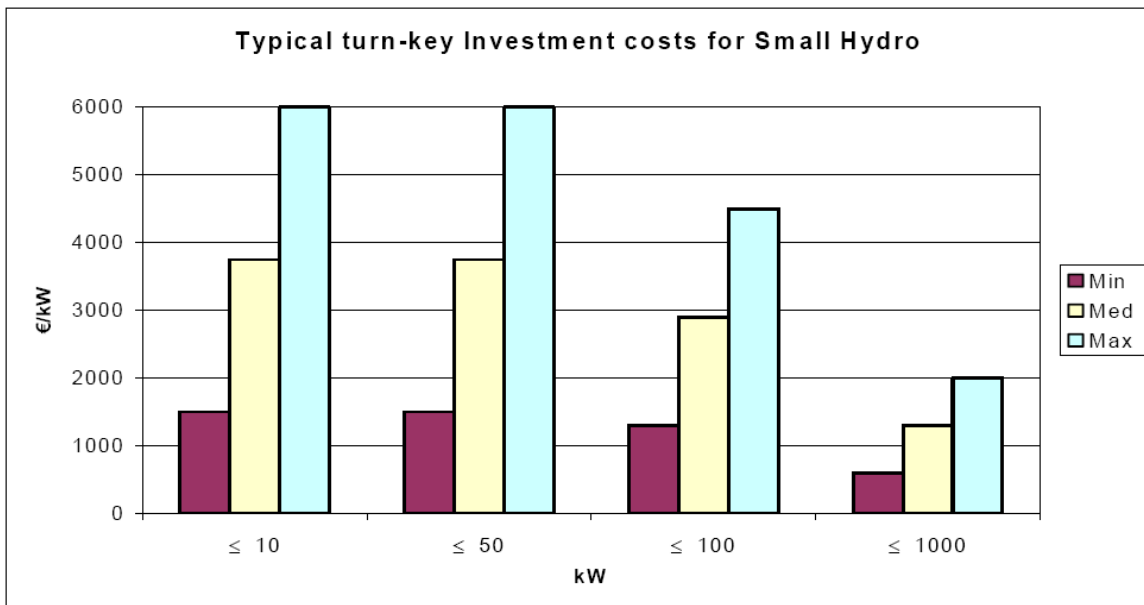

Figure 3.2.4. Investment costs specific to small hydro and scheme kW size

These figures suggest that in the smaller kW range investment costs can be as high as 6000 €/kW in extreme cases. However, as a cost estimate is essential for economic analysis, it is also necessary to produce a preliminary design, including the principal components of the scheme. Based on this design, budget prices for the materials can be obtained from suppliers. Such prices cannot be considered as firm prices until specifications and delivery dates have been provided. This will come later, during the actual design and procurement process. Do not forget that in a plant connected to the grid, the costs for connection to the grid should be included, because according to various national regulations this line, although it often remains the property of the grid company,

it is always built at the expense of the SHP developer. A plant close to the grid connection point will be always cheaper than one installed far from it. The same reasoning can be applied to telephone lines. In an unmanned plant, a telephone line to transmit telemetry and alarm signals is frequently used although, occasionally it might be cheaper to use the transmission line itself to establish a radio link. The use of the digital cellular telephone network is also increasingly used provided there is sufficient coverage.

The economic analysis is a comparison of costs and benefits that enables the investor/investors to make an informed choice whether to develop the project or abandon it. It is also possible that a choice may be made between different hydro projects so that the investment can be made in the one that gives the best return

From an economic viewpoint, a hydropower plant differs from a conventional thermal plant, because its initial investment cost per kW is much higher but the operating costs are extremely low, since there is no need to pay for fuel.

The economic analysis can be made by either, including the effect of the inflation, or omitting it. Working in constant monetary value has the advantage of making the analysis independent of the inflation rate. Valued judgements are easier to make in this way. Because the analysis refers cash flows to the present time it is easy to judge the overall value of the investment.

If there are reasons to believe that certain factors will evolve at a different rate from inflation, these must be treated with differential inflation rate. For instance, if we assume that electricity tariffs will grow two percent less than inflation, while the remaining factors stay constant in value, the electricity price should show a decrease in the analysis by 2% every year.

Financial analysis should cover estimation of annual costs and annual benefits of the project in monetised terms. The benefits should be estimated by compiling the tangible benefits to be accrued from the project on various accounts (explained later).

In addition, the intangible benefits like creation of employment, improvement of the standard of living, health and environment, etc should also be assessed (as accurately as possible in monetised terms) and duly considered for economic analysis. Based on above analysis, prioritization of implementation of the various components of the project could be prepared.

Planned large investment on any infrastructure project need to be evaluated on the basis of detailed feasibility analysis, especially in case of the project like Interlinking of Rivers (ILR) which involves a long gestation period. Financial Analysis (FA) will provide three very useful quantitative project evaluation measures - Cost Benefit Ratio, Economic Internal Rate of Return (EIRR) and Financial Internal Rate of Return (FIRR). The EIRR is the evaluation of the projects from the viewpoint of the national economy. The FIRR takes into account only the financial inflows, exclusive of economic benefits, and shows the financial/ commercial viability of the project, which is often a condition for long run sustainability of the project.

3.2.2. Capital (investment) costs

3.2.2.1. Costs of civil works

Development of SHPs has to face several problems linked to civil works:

- they represent a major proportion of the total cost, often more than 50 % (including the penstock, in the case of high heads), and prevent many small-low head sites to be built or rehabilitated,
- there is a lack of simple and generally applicable procedures and methods of realization,
- each SHP has to be environmentally integrated, which infers special equipments and constraints of construction.

Civil costs consist of the construction and hydro-structural costs of the project, including a reservoir dam, the water penstock structure, the power house, the tailrace structure, the access road and any future unpredicted costs taken from the preliminary designs of a feasibility study.

If it is necessary build a dam, a cost for a dam could be a major part of the project cost. Should be used the larger of the following alternative costs:

1. twice the cost of the intake weir, or
2. ten percent of the total civil, mechanical and electrical costs.

The tailrace channel is usually a minor cost item.

The specific cost of civil engineering works depends on the local situation of every specific site. More specifically, the characteristics of topography, geology, road access and local electricity grid of each site have such an influence that each project becomes a prototype. So, the risk of the budgetary deviations is quite high.

Concerning general design, one of the objectives is to favour a general reduction in costs, aiming at lowering the break event point and thus increasing the proportion of hydraulic potential, which could be recovered both technically, and economically, but which at present lies fallow.

This cost-reduction is particularly important in the case of small low-head plants, which have significant potential in Europe be they new, abandoned, or obsolete. There also exists a potential in existing infrastructures, like the impoundments used for irrigation.

3.2.2.2. Costs of hydro-mechanical and electro-mechanical equipment

Powerhouse construction costs are usually defined to include turbines and generators, control systems, communication facilities, ground mats, transformers, high and low voltage switching equipment, buswork, and the service equipment essential for operation of the powerhouse, as well as the powerhouse structure itself.

Intake works, gates, penstocks, and related features are generally not included in powerhouse cost estimates. These items are included in other civil feature cost accounts.

Powerhouse structure includes all materials and work needed to construct the actual structure which encloses the power plant equipment. For an existing structure, this account would include any remodeling or rehabilitation needed to bring the structure up to design specifications. Typical items included in this category are excavation and foundation, concrete, structural steel, and architectural features.

Turbine and generators include the major equipment and systems needed to convert the available energy in water to electrical energy: the turbines, generators, governors, excitation equipment, and cooling systems.

Accessory electrical equipment is item that control the generating unit and interconnect the generator with the switchyard. This account includes switchgear, circuit breakers, and station service and control systems.

Auxiliary systems and equipment include supporting systems and equipment and items not included in other powerhouse categories, such as heating and ventilating systems; piping, dewatering, and drainage systems; cranes and hoists; fire protection systems, etc.

Switch-yard provides the power interface between the power plant and the transmission system. This account consists primarily of the power transformers and related high-voltage equipment.

Site preparation and special items include those costs associated with contractor setup and other mobilization and preparation items.

A contingency allowance is applied to the powerhouse construction cost in order to account for uncertainty in the cost estimate. The magnitude of the contingency allowance varies with the level of study. In estimating powerhouse costs, it is sometimes desirable to apply different allowances to different cost components. For example, there is usually more uncertainty associated with foundation and excavation work than with major power plant equipment such as turbines and generators.

Sources of powerhouse cost data are reference publications, reports, etc. The data contained in these reports was developed primarily from statistical studies of historical cost data and is presented in the form of curves and equations. The data from these reports is not all-inclusive, and the user must index cost data to current price levels. It must be emphasized that these estimates are very general and are appropriate only for preliminary studies.

3.2.2.3. Cost of grid connection (power transmission line)

Transmission costs consist of the cost of the transmission line and substation equipment needed to transfer generated power to the regional transmission grid. Transmission costs vary depending on the location of the proposed project relative to the existing system and on the size of the project. For some projects, transmission requirements may be minor, because existing transmission facilities are nearby. In other cases, transmission costs can be a significant part of project costs, due to a remote site location, difficult topography, or right-of-way constraints.

For some projects, it is possible to clearly identify the increment of transmission facilities required for a proposed hydro-project, but often the analysis is more complex. For example, the transmission facilities carrying the project's output to the load center(s) may also be used by other generating projects or may be required for system stability or reliability. In these instances, a portion of the transmission costs should be allocated to these other users. In cases where modification or replacement of existing transmission lines would be required, it is necessary to estimate transmission facility costs both with and without the proposed hydro project. The difference between these costs is the economic cost of transmission chargeable to the project.

3.2.2.4. Other indirect costs

Include Engineering and Design (E&D) cost, Supervision and Administration (S&A) cost, inflation costs and interest during the construction period.

The magnitude of E&D costs is influenced by many factors, including the types size, and geographical location of the project. In the early stages of study, E&D costs are usually

treated as a percentage of the construction cost, and the value used varies somewhat from district to district. Recently, a case study on these SHPs has shown that this figure could range from 5% for small and medium sized projects, to 8%, for very large sized projects. As a project moves into the design memorandum stages, project-specific E&D costs are often computed.

S&A costs include field office and inspection costs, construction management costs, etc. These items are treated similarly to E&D costs. A percentage of construction costs is generally used in the pre-authorization studies, and project-specific cost estimates are often developed for design memoranda. A recent case study on HPPs has shown that this figure could be anywhere from 6% to 8%.

A hydropower project is usually constructed over a period of several years. During this time, the price of the items necessary to build the project may escalate due to inflation. Contractors making bid estimates on projects are aware of these effects and increase their bid estimates accordingly. If the construction cost estimates are based upon past contractor bid prices, these inflated cost estimates must be adjusted to a base year for proper economic analysis. The inflation adjustment would be applied to the construction cost, thus providing an adjusted (inflation-free) construction cost for use in the economic analysis. If the cost estimates are based upon spot prices for work to be done or materials to be delivered immediately, the estimates need not be adjusted for inflation.

Interest during construction (IDC) accounts for the cost of capital during the construction period. IDC computations are based on the projected power on-line date. IDC is compounded on all expenditures preceding that date, and all expenditures incurred after that date are discounted from their expected expenditure date to the power on-line date. For very preliminary studies, a uniform distribution of costs over the period of construction can be assumed. However, for most reconnaissance and all feasibility studies, a year-by-year distribution of costs should be used. Interest during construction is applied to the total project cost (construction cost plus E&D and S&A).

Table 3.2.1 presents developed correlations for determination capital costs for alternative SHP having one, two, three or four turbines obtained by regression analysis. All costs are taken in Indian rupees (Rs.) (US\$ 1 = Rs. 42 approximately in August 2008).

Table 3.2.1. Correlations for costs of dam-toe SHP schemes

Components of work/equipment	Cost per kW for alternative layout (Rs.)			
	With one unit	With two units	With three units	With four units
Civil works				
Intake (C ₁)	14382 P ^{-0.2368} H ^{-0.0598}	17940 P ^{-0.2366} H ^{-0.0596}	21191 P ^{-0.2367} H ^{-0.0597}	24164 P ^{-0.2371} H ^{-0.0600}
Penstock (C ₂)	4906 P ^{-0.3722} H ^{0.3866}	7875 P ^{-0.3806} H ^{0.3804}	9001 P ^{-0.369} H ^{0.389}	10649 P ^{-0.3669} H ^{0.3905}
Powerhouse building (C ₃)	62246 P ^{-0.2354} H ^{-0.0587}	92615 P ^{-0.2351} H ^{-0.0585}	121027 P ^{-0.2356} H ^{-0.0589}	146311 P ^{-0.2357} H ^{-0.0589}
Tail-race channel (C ₄)	28164 P ^{-0.376} H ^{-0.624}	28164 P ^{-0.376} H ^{-0.624}	28164 P ^{-0.376} H ^{-0.624}	28164 P ^{-0.376} H ^{-0.624}
Electro-mechanical equipment				
Turbine with governing system (C ₅)	39485 P ^{-0.1902} H ^{-0.2167}	63346 P ^{-0.1913} H ^{-0.2171}	83464 P ^{-0.1922} H ^{-0.2178}	101464 P ^{-0.1920} H ^{-0.2177}
Generator with excitation system (C ₆)	48568 P ^{-0.1867} H ^{-0.2090}	78661 P ^{-0.1855} H ^{-0.2090}	105046 P ^{-0.1859} H ^{-0.2085}	127038 P ^{-0.1858} H ^{-0.2085}
Mechanical and electrical auxiliaries (C ₇)	31712 P ^{-0.1900} H ^{-0.2122}	40860 P ^{-0.1892} H ^{-0.2118}	49338 P ^{-0.1898} H ^{-0.2080}	56625 P ^{-0.1896} H ^{-0.2121}
Main transformer and switchyard equipment (C ₈)	14062 P ^{-0.1817} H ^{-0.2082}	18739 P ^{-0.1803} H ^{-0.2075}	23051 P ^{-0.1811} H ^{-0.2080}	26398 P ^{-0.1809} H ^{-0.2079}
Cost per kW of civil work (C _c) (Rs.) = C ₁ +C ₂ +C ₃ +C ₄				
Cost per kW of electro-mechanical equipment (C _{em}) (Rs.) = C ₅ +C ₆ +C ₇ +C ₈				
Total cost per kW (Rs.) = 1.13x(C _c +C _{em})				

3.2.3. Annual costs

In addition to investment costs, annual costs should be calculated to obtain the net benefit of a project. Annual costs include depreciation of equipment, Operating & Maintenance (O&M), and replacement and renovation costs. Also, the cost of pumping energy is a part of the annual operating costs for pumped-storage projects.

3.2.3.1. Depreciation of equipment

In the economical analysis of the project, depreciation and other factors affecting the equipment should be considered (interest and amortization). Amortization of investment cost is the process of spreading the project's cost over its economic life to determine an equivalent annual cost. This requires the computation of an amortization factor based upon the annual interest rate and economic life. The interest rate for a given project must be adjusted annually through the planning process, but once construction funds are appropriated, the project interest rate is fixed. The same interest rate is used for interest during construction calculations.

3.2.3.2. Operation and Maintenance (O&M) costs

Operation and Maintenance (O&M) costs represent the average annual costs of maintaining the project at full operating efficiency throughout project life. This includes salaries of operating personnel; the cost of labor, plant, and supplies for ordinary maintenance and repairs; and applicable supervisory and overhead costs. Some of the costs of operating multiple purpose projects are joint costs, which must be apportioned among all project functions, including hydropower. These joint O&M costs are allocated to project purposes on the same basis that joint construction costs are allocated, but the distribution percentages are not usually identical.

O&M costs are usually a function of installed capacity and type of operation. The operation of power projects is divided into two general categories: local and remote. Projects that are operated locally have operators on-station. Typical projects of this type are older power projects and new power projects where the location or the complexity of operation requires a manned station. Remote operation is performed by automated equipment, with operating instructions transmitted being from a centralized source. The complexity of the control equipment depends on plant size and location. When two or more plants are located in one area, it is often possible to operate them all from one location. In these cases, it is also common to perform maintenance at all projects with a single crew.

Total O&M costs generally decrease with plant size down to a fixed minimum level, which is necessary to cover minimum personnel and supply costs. The O&M cost can be split into the fixed maintenance cost FC and the variable one VC. The variable O&M mainly depends on the replacement of major parts of installation, which may have a shorter lifetime than the complete power station.

3.2.3.3. Replacement and renovation costs

Replacement costs are because certain major components of a powerhouse require replacement before the end of the project life. Examples are generator windings, turbine runners, thrust bearings, pumps, air compressors, communications equipment, generator, voltage regulation and excitation equipment, and certain types of transformers. The replacement cost for a facility is the estimated future cost of such replacements, converted to an equivalent average annual value over the entire project life.

To estimate these costs, the percentage of renovation and replacement should be determined for different sections separately.

Replacement costs can also be estimated from the construction cost estimate using an approximate procedure based on composite service lives. Detailed cost estimates were examined for a number of powerhouses of different types, and estimates were made of the percentage of each cost account that represents equipment that would require replacement at least once during project life. Service lives were then assigned to each piece of equipment requiring replacement, and composite service lives were developed for each cost account. In developing these composite service lives, the service life for each component (the generator windings, for example) was weighted by the cost of that component.

The annual replacement cost for each cost account is estimated by (a) computing the portion of the construction cost (including contingencies) that requires replacement during the life of the project, then (b) computing the present worth of that cost based on its composite service life and the project interest rate, and finally (c) amortizing the present worth amount over the composite service life. This procedure results in the determination of the amount required to be deposited annually in a sinking fund, earning interest at the project interest rate, in order to accumulate an amount equal to the estimated replacement cost. This analysis, of course, ignores future increases in replacement costs resulting from general inflation.

For reconnaissance studies where a detailed powerhouse cost breakdown is not available, the annual replacement costs can be approximated as 0.2 percent of the powerhouse cost estimate.

3.2.3.4. Pumping costs

At pumped-storage projects estimation of the average annual pumping energy requirement can be obtained from sequential routing studies or from power system production cost studies. Hourly production cost studies can be used to determine when pumped-storage operation is economical for both pump-back and off-stream projects, and they can also be used to estimate the average annual pumping requirement. To estimate pumping costs, the unit cost of pumping energy must also be determined. The value should reflect the same base fuel costs, price levels, and real fuel cost assumptions as the power values used for estimating energy benefits.

3.2.4. Income and benefits

There are two benefits for the SHPs: (1) tangible benefits and (2) intangible benefits. The tangible benefit is the sale of electrical energy. In each case, the electrical energy purchasing rates are being provided in different months of the year based on the peak load, normal load and low load. Due to peak hours of energy consumption, the purchasing rate would be more attractive for the producer of energy. The intangible benefits cover the positive environmental effects, agriculture and irrigation, fish farm pools, camps and recreation centers which eventually turn into quantitative values. The intangible benefits are not included in this economic analysis of the project, but naturally a more desirable result will be obtained for the economic indices when taking these factors into account

3.2.5. Financial analysis

3.2.5.1. Financial mathematics

An investment project considers revenues and expenses that take places in very different periods. The “time value of money” is the concept that a Euro received today is worth more than a Euro received at some point in the future, because the Euro received today can be invested to earn interest. Time value of money analysis generally involves the relationship between a certain amount of money, a certain period and a certain rate of compound interest. An investment project considers revenues and expenses that take place in very different time periods. In any economic analysis involving economic value there are always two variables, money and time. A certain amount of money paid or received at a point in time has a different value if it is paid or received at another point in time. Money can be invested during a certain period of time with the guarantee of a certain benefit. The term “present value” stands for the current value of a future amount of money or a series of payments, evaluated at a given interest rate. In order to determine the present value (*PV*) of a future amount of money or future value (*FV*), discounted at a given interest rate “*r*” (also called discounted rate), for a number of years “*n*”, the following formula is used:

$$PV_0 = \frac{FV_n}{(1+r)^n} = \frac{1}{(1+r)^n} FV_n \quad [3.2.1]$$

The term $1/(1+r)^n$ is called “present value factor” (PVF). Table 5.3.1 gives the value of this multiplier for different interest rates and time periods. Therefore, for a discounting rate r , the cost C_n (or the benefit B_n), disbursed or received in the year n , is discounted to the year zero by the equation:

$$C_0 = \left[\frac{1}{(1+r)^n} \right] C_n \quad [3.2.2]$$

The fraction within square brackets is “present value factor”. To find the comparable value of a given sum of money if it were received, or disbursed, at a different time, the above formula may be used or the corresponding PVF as given in left hand columns of Table 5.3.1 may be multiplied by the given sum. For instance, if the investor's opportunity earning potential were 8%, then €1500 received in 5 years from now, would be equivalent to a present value of:

$$\left[\frac{1}{(1+0.08)^5} \right] 1500 = €1020.9$$

Cash flows occurring at different times can be converted to a common basis, using the discount method, either using the formulae, available on an electronic spreadsheet, or the Table 5.3.1. In Table 5.3.1, the discount factors are calculated from the discount formulas for various time periods and opportunity costs (expressed as rate of discount r). The time periods can be years, quarters, months etc. and the periodic discount rate will correspond to the period rate. If r is the annual discount rate then $r/4$ will be the discount rate corresponding to a quarter and $1/12r$ the corresponding rate for a month.

With the concept of present value for a future payment, investors can calculate the present value of the future sales price of a SHP plant. The formula is useful in understanding that an investment today has to be sold at a much higher price in the future if the investment is to be interesting from an economic point of view. Although the PVF could be used to solve any present value problem that would arise, it is convenient to define a second term in order to speed the arithmetic process: the present value of an annuity.

An annuity is a series of equal payments over a certain period of time. The present value of an annuity over n years, with an annual payment C (starting at the end of the first year) will be the result of multiplying C by a factor, a_n , equal to the sum of present value factors, PVF 's (v):-

$$a_n = v^1 + v^2 + v^3 + \dots + v^n .$$

It can be demonstrated that,

$$a_n = \frac{1 - v_n}{r} = \frac{(1+r)^n - 1}{r(1+r)^n} = \frac{1 - (1+r)^{-n}}{r} \quad [3.2.3]$$

Annuities are payments occurring regularly over a period of time “*n*”. With “*C*” being the annual payment and “*PVA*” the present value of the annuity, we can express the present value as the sum of future payments discounted at “*r*”:

$$PVA_n = C \left[\sum_{t=1}^n \frac{1}{(1+r)^t} \right] = C \frac{1 - \frac{1}{(1+r)^n}}{r} = C \frac{1 - (1+r)^{-n}}{r} = Ca_n \quad [3.2.4]$$

For instance the present value for a series of 200 Euro payments, over three years beginning at the end of the first year, will be given by the equation 3.2.4 and the PVF in the right hand columns of Table 3.2.1. Assuming a discount rate of 8% then:

$$PVA_3 = 200 \left[\sum_{t=1}^3 \frac{1}{(1+0.08)^t} \right] = 200 \frac{1 - \frac{1}{(1+0.08)^3}}{0.08} = 200 * 2.5771 = 515.42 \text{ €}$$

The concept of present value of an annuity allows the evaluation of how much the annual sales revenue from the SHP plant electricity is worth to the investor. With electricity sales price of 4€cts/kWh and a yearly production of 100000 kWh, revenue per year (the annuity) is 4000€. What would be the value of this revenue stream over 10 years at present for a required return of 8% for the investor? Again, applying formula 3.2-4 and Table 3.2.2 values:

$$PVA_{10} = 4000 \frac{1 - \frac{1}{(1+0.08)^{10}}}{0.08} = 4000 * 6.7101 = 26840.4 \text{ €}$$

Table 3.2.2. Present Value Factor (PVF) for various time periods’ *n* and opportunity cost *r*

n/r	Single payment				Uniform series of payments			
	6%	8%	10%	12%	6%	8%	10%	12%
1	0.9434	0.9259	0.9091	0.8929	0.9434	0.9259	0.9091	0.8929
2	0.8900	0.8573	0.8264	0.7972	1.8334	1.7833	1.7355	1.6901
3	0.8396	0.7938	0.7513	0.7118	2.6730	2.5771	2.4869	2.4018
4	0.7921	0.7350	0.6830	0.6355	3.4651	3.3121	3.1699	3.0373
5	0.7473	0.6806	0.6209	0.5674	4.2124	3.9927	3.7908	3.6048
6	0.7050	0.6302	0.5645	0.5066	4.9173	4.6229	4.3553	4.1114
7	0.6651	0.5835	0.5132	0.4523	5.5824	5.2064	4.8684	4.5638
8	0.6274	0.5403	0.4665	0.4039	6.2098	5.7466	5.3349	4.9676
9	0.5919	0.5002	0.4241	0.3606	6.8017	6.2469	5.7590	5.3282
10	0.5584	0.4632	0.3855	0.3220	7.3601	6.7101	6.1446	5.6502
11	0.5268	0.4289	0.3505	0.2875	7.8869	7.1390	6.4951	5.9377
12	0.4970	0.3971	0.3186	0.2567	8.3838	7.5361	6.8137	6.1944
13	0.4688	0.3677	0.2897	0.2292	8.8527	7.9038	7.1034	6.4235

14	0.4423	0.3405	0.2633	0.2046	9.2950	8.2442	7.3667	6.6282
15	0.4173	0.3152	0.2394	0.1827	9.7122	8.5595	7.6061	6.8109
16	0.3936	0.2919	0.2176	0.1631	10.1059	8.8514	7.8237	6.9740
17	0.3714	0.2703	0.1978	0.1456	10.4773	9.1216	8.0216	7.1196
18	0.3503	0.2502	0.1799	0.1300	10.8276	9.3719	8.2014	7.2497
19	0.3305	0.2317	0.1635	0.1161	11.1581	9.6036	8.3649	7.3658
20	0.3118	0.2145	0.1486	0.1037	11.4699	9.8181	8.5136	7.4694
21	0.2942	0.1987	0.1351	0.0926	11.7641	10.0168	8.6487	7.5620
22	0.2775	0.1839	0.1228	0.0826	12.0416	10.2007	8.7715	7.6446
23	0.2618	0.1703	0.1117	0.0738	12.3034	10.3711	8.8832	7.7184
24	0.2470	0.1577	0.1015	0.0659	12.5504	10.5288	8.9847	7.7843
25	0.2330	0.1460	0.0923	0.0588	12.7834	10.6748	9.0770	7.8431
26	0.2198	0.1352	0.0839	0.0525	13.0032	10.8100	9.1609	7.8957
27	0.2074	0.1252	0.0763	0.0469	13.2105	10.9352	9.2372	7.9426
28	0.1956	0.1159	0.0693	0.0419	13.4062	11.0511	9.3066	7.9844
29	0.1846	0.1073	0.0630	0.0374	13.5907	11.1584	9.3696	8.0218
30	0.1741	0.0994	0.0573	0.0334	13.7648	11.2578	9.4269	8.0552
31	0.1643	0.0920	0.0521	0.0298	13.9291	11.3498	9.4790	8.0850
32	0.1550	0.0852	0.0474	0.0266	14.0840	11.4350	9.5264	8.1116
33	0.1462	0.0789	0.0431	0.0238	14.2302	11.5139	9.5694	8.1354
34	0.1379	0.0730	0.0391	0.0212	14.3681	11.5869	9.6086	8.1566
35	0.1301	0.0676	0.0356	0.0189	14.4982	11.6546	9.6442	8.1755
36	0.1227	0.0626	0.0323	0.0169	14.6210	11.7172	9.6765	8.1924
37	0.1158	0.0580	0.0294	0.0151	14.7368	11.7752	9.7059	8.2075
38	0.1092	0.0537	0.0267	0.0135	14.8460	11.8289	9.7327	8.2210
39	0.1031	0.0497	0.0243	0.0120	14.9491	11.8786	9.7570	8.2330
40	0.0972	0.0460	0.0221	0.0107	15.0463	11.9246	9.7791	8.2438

3.2.5.2. Methods of economic evaluation

While the payback period method is the easiest to calculate most accountants would prefer to look at the net present value and the internal rate of return. These methods take into consideration the greatest number of factors, and in particular, they are designed to allow for the time value of money.

When comparing the investments of different projects the easiest method is to compare the ratio of the total investment to the power installed or the ratio of the total investment to the annual energy produced for each project. This criteria does not determine the profitability of a given scheme because the revenue is not taken into account and is really an initial evaluation.

Static methods

Payback method. The payback method determines the number of years required for the invested capital to be offset by resulting benefits. The required number of years is termed the payback, recovery, or break-even period. The calculation is as follows:

$$\text{Payback period} = \frac{\text{Investment cost}}{\text{Net annual revenue}}$$



The method usually neglects the opportunity cost of capital. The opportunity cost of capital is the return that could be earned by using resources for an alternative investment rather than for the purpose at hand. Investment costs are usually defined as first costs (civil works, electrical and hydro mechanical equipment) and benefits are the resulting net yearly revenues expected from selling the electricity produced, after deducting the operation and maintenance costs, at constant value money. The payback ratio should not exceed 7 years if the small hydro project is to be considered profitable.

However, the payback does not compare the selection from different technical solutions for the same installation, or choosing among several projects that may be developed by the same promoter. In fact it does not consider cash flows beyond the payback period and thus does not measure the efficiency of the investment over its entire life.

Under the payback method of analysis, projects or purchases with shorter payback periods rank higher than those with longer paybacks do. The theory is that projects with shorter paybacks are more liquid, and thus represent less of a risk.

For the investor, when using this method it is advisable to accept projects that recover the investment and if there is a choice, select the project, which pays back earliest. This method is simple to use but it is attractive if liquidity is an issue but does not explicitly allow for the “time value of money” for investors.

Return on investment method. The return on investment (*ROI*) calculates average annual benefits, net of yearly costs, such as depreciation, as a percentage of the original book value of the investment. The calculation is as follows:

$$ROI = \frac{\text{Net annual revenue} - \text{Depreciation}}{\text{Investment cost}} \times 100$$

For purposes of this formula, depreciation is calculated very simply, using the straight- line method:

$$\text{Depreciation} = \frac{\text{Cost} - \text{Salvage value}}{\text{Operation life}}$$

Using *ROI* can give you a quick estimate of the project's net profits, and can provide a basis for comparing several different projects. Under this method of analysis, returns for the project's entire useful life are considered (unlike the payback period method, which considers only the period that it takes to recoup the original investment). However, the *ROI* method uses income data rather than cash flow and it completely ignores the time value of money. To get around this problem, the net present value of the project, as well as its internal rate of return should be considered.

Dynamic methods

These methods of financial analysis take into account total costs and benefits over the life of the investment and the timing of cash flows.

Net Present Value (NPV) method. *NPV* is a method of ranking investment proposals. The net present value is equal to the present value of future returns, discounted at the

marginal cost of capital, minus the present value of the cost of the investment. The difference between revenues and expenses, both discounted at a fixed, periodic interest rate, is the net present value (*NPV*) of the investment, and is summarised by the following steps:

1. Calculation of expected free cash flows (often per year) that result out of the investment;
2. Subtract /discount for the cost of capital (an interest rate to adjust for time and risk) giving the Present Value;
3. Subtract the initial investments giving the Net Present Value (*NPV*).

Therefore, net present value is an amount that expresses how much value an investment will result in, in today's monetary terms. Measuring all cash flows over time back towards the present time does this. A project should only be considered if the *NPV* results in a positive amount.

The formula for calculating *NPV*, assuming that the cash flows occur at equal time intervals and that the first cash flows occur at the end of the first period, and subsequent cash flow occurs at the ends of subsequent periods, is as follows:

$$NPV = \sum_{i=1}^n \frac{R_i - (I_i + O_i + M_i)}{(1+r)^i} + V_r, \quad [3.2.5]$$

where: I_i - investment in period i ;

R_i - revenues in perion i ;

O_i - operating costs in period i ;

M_i - maintenance costs in period i ;

V_r - residual value of the investment over its lifetime, where equipment lifetime exceeds the plant working life;

r - periodic discount rate, where the period ia a quarter, the periodic rate is $\frac{1}{4}$ of the annual rate;

n - number of lifetime periods e.g. years, quarters, months, etc.

The calculation is usually done for a period of thirty years, because due to the discounting techniques used in this method both revenues and expenses become negligible after a larger number of years.

Different projects may be classified in order of decreasing *NPV*. Projects where *NPV* is negative will be rejected, since that means their discounted benefits during the lifetime of the project are insufficient to cover the initial costs. Among projects with positive *NPV*, the best ones will be those with greater *NPV* value.

The *NPV* results are quite sensitive to the discount rate, and failure to select the appropriate rate may alter or even reverse the efficiency ranking of projects. Since changing the discount rate can affect the outcome of the evaluation, the rate used should be chosen carefully. For a private developer, the discount rate will be such that allows him to choose between investing in a small hydro project or in keeping his saving in the bank. This discount rate, depending on the inflation rate, usually varies between 5% and 12%.

If the net revenues are constant in time (uniform series), their discounted value is given by the equation 3.2.3.

The method does not distinguish between projects with high investment costs promising a certain profit, from another that produces the same profit but needs a lower investment, as both have the same *NPV*. Hence a project requiring €1 000 000 in present

value and promises €1 100 000 profit shows the same *NPV* as another one with a €100 000 investment and promises €200 000 profit (both in present value). Both projects will show a €100 000 *NPV*, but the first one requires an investment ten times higher than the second does.

There has been some debate regarding the use of a constant discount rate when calculating the *NPV*. Recent economic theory suggests the use of a declining discount rate is more appropriate for longer-term projects – those with a life-span over thirty years and in particular infrastructure projects. Examples of these could be climate change prevention, construction of power plant and the investment in long-term infrastructure such as roads and railways. Taking Climate Change as an illustrative example, mitigation costs are incurred now with the benefits of reduced emissions only becoming apparent in the distant future. When using a constant discount rate these benefits are discounted to virtually zero providing little incentive, however the declining discount rate places a greater emphasis on the future benefits.

Correct use of a declining discount rate places greater emphasis on costs and benefits in the distant future. Investment opportunities with a stream of benefits accruing over a long project lifetime therefore appear more attractive.

Benefit-Cost ratio. The benefit-cost method compares the present value of the plant benefits and investment on a ratio basis. It compares the revenue flows with the expenses flow. Projects with a ratio of less than 1 are generally discarded. Mathematically the *R_{b/c}* is as follows:

$$R_{b/c} = \frac{\sum_0^n \frac{R_n}{(1+r)^n}}{\sum_0^n \frac{I_n + M_n + O_n}{(1+r)^n}}, \quad [3.2.6]$$

where the parameters are the same as stated in formula 3.2.5.

Internal Rate of Return method. The internal rate of return (*IRR*) method of analysing a project allows the consideration of the time value of money. Basically, it determines the interest rate that is equivalent to the Euro returns expected from the project. Once the rate is known, it can be compared to the rates that could be earned by investing the money in other projects or investments. If the internal rate of return is less than the cost of borrowing used to fund your project, the project will clearly be a money-loser. However, usually a developer will insist that in order to be acceptable, a project must be expected to earn an *IRR* that is at least several percentage points *higher* than the cost of borrowing. This is to compensate for the risk, time and problems associated with the project.

The criteria, for selection between different alternatives is, usually, to choose the investment with the highest rate of return.

To find the *IRR* a process of trial and error is used, whereby the net cash flow is computed for various discount rates until its value is reduced to zero. Electronic spreadsheets use a series of approximations to calculate the internal rate of return. The following examples illustrate how to apply the above-mentioned methods to a hypothetical small hydropower scheme:

3.2.5.3. Tariffs and incentives

A developer's economic analysis of a scheme would be simplified if electricity tariffs for a MWh were a known and stable entity. However, this is not the case and the markets vary constantly – the present move to liberalise and open up the markets to competition and the promotion of RE's serves as a good example. Tariffs are agreed in different ways between the generator and supplier and are influenced by national policy. These policies can and do vary from country to country and are reviewed and altered frequently making it difficult to provide more than an overview. Tariffs negotiated through some form of power purchase agreement with the supplier will vary from country to country and will be strongly influenced by that country's national policy. It is therefore important for the developer to understand clearly the implications of the national policy. Similarly, the developer should investigate what supplementary measures are available for the promotion of new RE developments. Table 3.2.3. shows the current prices agreed within the different support schemes in force in the year 2003 in the EU.

Table 3.2.3. The current prices agreed within the different support schemes in force in the year 2003 in the EU

Member State	Price for sale to the grid (€cents/kWh)
Belgium	Wallonia: $12.3 = 3.3$ (market price) + 9 (green certificate) Flanders: $12.8 = 3.3$ (market price) + 9.5 (green certificate)
Denmark	8.48
Germany	7.67 (< 500 kW) 6.65 (500 kW - 5 MW)
Greece	<i>Interconnected system: 6.29 + 113/month</i> <i>Non-interconnected islands: 7.78</i>
Spain	$6.49 = 3.54$ (pool price) + 2.95 (premium)
France	Operating before 2001: 7.32 + bonus for regularity of 0.75 (winter) and 2.94 (summer) Commissioned after 2001: <i>SHP < 500 kW: 8.55 + regulatory premium up to 1.52 (winter) and 4.52 (summer)</i> <i>SHP > 500 kW: 7.69 + + regulatory premium up to 1.52 (winter) and 4.07 (summer)</i>
Ireland	6.41 (weighted average price)
Italy	4.6 (spot electricity price) + 10.0 (green certificates)
Luxembourg	3.1 (electricity price) + 2.5 (premium only for plants under 3 MW)
Netherlands	3.3 (market price) + 6.8 (premium)

Austria	<u>Old plants</u> st 1 GWh: 5.68 1 – 4 GWh: 4.36 4- 14 GWh: 3.63 14-24 GWh: 3.28 + 24 GWh: 3.15 <u>New plants</u> <i>Rebuilt plants with a production increase per year > 15%</i> st 1 GWh: 5.96 1 – 4 GWh: 4.58 4- 14 GWh: 3.81 14-24 GWh: 3.44 + 24 GWh: 3.31 <i>New plants or Rebuilt plants with a production increase per year > 50%</i> st 1 GWh: 6.25 1 – 4 GWh: 5.01 4- 14 GWh: 4.17 14-24 GWh: 3.94 + 24 GWh: 3.78
Portugal	7.2
Finland	2.6 (market price) + 0.42 premium if < 1 MW + subsidy covering 30% of the investment cost
Sweden	4.9 = 2.3 (certificate level) + 2.6 (Nordpool price)
United Kingdom	2 (Average price for electricity in the energy market) + 0.38 (exemption to the Climate Change Levy) 4.2 (value of ROC's). When an electrical supply company provide renewable energy to 10% of its costumers it gets the 4.2 but if it fails to provide that percentage it has to pay 4.2 to the government.

3.2.5.4. Revenue assessment - analysis of the financial behaviour of a small hydro power plant

In the following, the impact of the key parameters on the IRR value of a SHP plant is examined in the course of time (i.e. years of operation).

Capacity factor. The capacity factor value of a SHP plant depends on the water potential of installation site and on the power curve of hydro turbine utilized. Additionally, the technical availability of the power station also influences the exact CF value. The dominant impact of CF on the IRR value of a SHP investment may be observed. More precisely, there is an almost positive linear relation between IRR and CF values (i.e. 0.5% IRR amelioration for every 1% CF increase), which is almost independent of the operation time, especially for low CF values. On top of that, for CF values exceeding 30%—which is a very conservative value—the 10- and 15-year IRR value, respectively, exceed 14% and 13.5%, a rather motivating financial efficiency of similar risk energy production installations.

Subsequently, the combined impact of the CF value and the subsidization percentage on the IRR value of a typical SHP investment may be examined. The positive linear relation between IRR and CF is revalidated. However, the slope of the IRR–CF curve in case of state subsidization is higher than in case of no-subsidization. This outcome is quite unexpected; as one may assume that realization of low capacity installations need further financial support than those of high water potential regions.

Number of hydro turbines used. The next parameter is the number of hydro turbines used. The usage of one or two hydro turbines maximizes the IRR value of the installation, while the utilization of the third turbine leads to IRR value decrease by almost 3%. Since the IRR value is almost the same for $z/4$ 1 and 2, other criteria—like improved reliability, uncomplicated maintenance process, etc.—should also be considered, in order to decide on the optimum hydro turbines number.

Turnkey cost. The initial investment cost (turnkey cost) includes the ex-works price of the required equipment and the corresponding balance of the plant cost. Application of new technological achievements and economies of scale reduce the price of a SHP installation. Besides, the installation head is in inverse proportion to the water volume required for a given power produced; therefore smaller and low-cost equipment is required. However, high head sites are usually disposed in mountainous areas of low population density and poor infrastructure. In similar cases, long electricity transmission distances to the main consumption centres nullify any profits of remote high head SHP stations. The years of operation hardly affect the IRR value.

Subsidization impact. During the last 20-year period, the EU and the corresponding country members remarkably subsidized investments in the energy production sector, under the precondition of clean energy production, i.e. utilization of renewable energy sources. For example in Greece, all SHP applications are currently subsidized by 40% of the initial capital invested, while this value formerly was 50%. In several other EU countries, it is not the initial capital but the energy production price that is financially supported, in an attempt to guarantee enduring and regular operation of the power station. Bear in mind that this subsidization amount is only a portion of the evaded environmental and macro-economic outlay and benefits from the operation of renewable energy production stations instead of fossil fuel fired plants. The IRR distribution is enhanced in cases of initial cost subsidization comparatively to the non-subsidized ones. This disparity is almost 15% for the first years of operation of the power station, being slightly decreased to 10% for long-term operation of the investment.

Electricity price escalation rate. The term “electricity price escalation rate” is hereby used to describe the annual rate of change of the electrical energy (and power) market prices, as according to the existing legislative frame. The electricity generated by the SHP stations is finally sold to the local network at a price directly related to the corresponding retail price. The IRR value is significantly increasing with the electricity price escalation rate. More precisely, there is an almost linear positive relation between IRR and escalation rate, leading to 1.5% IRR rise as escalation rate increases by 1%. Similar to previous cases, the impact of operational years is limited.

Maintenance and operation (M&O) cost inflation rate. The inflation rate expresses the tendency of everyday life cost to increase in the course of time. Thus, the M&O cost inflation rate describes the annual escalation of the M&O cost, in view of the annual changes of labour cost and the corresponding spare parts. Generally speaking, M&O cost inflation rate follows the market inflation rate tendency, being usually one or two percentage units lower. In this context, M&O cost inflation rate has a negative and relatively small direct influence on the IRR value of a SHP plant, since an almost 8% change of the M&O cost inflation rate practically imposes a 2% on the 15-year IRR value and an 1.5% on the 10-year IRR value decrease.

Investment residual value. As already mentioned, the residual value of an investment after n years of operation considers the current value of the installation. This numerical value is usually predicted using at first logistic methods (based on depreciation models and taking into account the financial obligations of the enterprise) and then qualitative estimations regarding the experience gained and the corresponding technological know-how transfer that cannot easily be quantified. Additionally, the impact of investment residual value is normally investigated after the fifth year of operation, given that 5 years is the normal loan amortization period.

The impact of investment residual value on the corresponding IRR is important for the first decade of operation. After this period, the IRR profiles converge, almost independently of the residual model adopted, especially after the 15th year of operation. Additionally, the investment IRR value is remarkably increasing with time. Finally, in any case the IRR value is above 20% for 10 years of operation of the investment under investigation, while the residual value of the investment is in proportion to the corresponding IRR value.

Taxation impact. According to the existing tax-law, every energy production company pays an amount per annum, mostly attributable to the gains of the previous year. This amount depends on the law defined tax coefficient j ; the investment revenue, the annual maintenance and operational cost, the debt repayment method, the investment depreciations, etc. Although the taxation does not change the IRR versus time distribution (as the residual value does), it reduces the corresponding IRR values from 3% for a 10-year operation period up to almost 5% for a longer service period of the power plant.

Recapitulating, one may classify the impact of all above-analysed parameters on the IRR value of a SHP as follows :

- The installation capacity factor and the electricity price escalation rate affect the IRR value of the investment quite positively;
- The state subsidization and the residual value of the examined power station undeniably influence quite positively the corresponding IRR value;
- The impact of the first installation (reduced) cost increase on the IRR value is strongly negative. The maintenance and operation cost inflation rate and the tax coefficient increase affect the financial viability of the investment in a negative way;
- The number of the hydro turbines used in the plant, given the maximum rated power, imposes a parabolic distribution of the corresponding IRR value, providing the opportunity to select the optimum configuration of a SHP station.

3.2.5.5. Financing strategy

Best practice suggests that the expansion of micro hydro will continue to need both “soft Funds” and funds at commercial rates, particularly if micro hydro is to meet the needs of people with low money incomes:

- Funding will be needed to cover capital costs, technical assistance and social/organisational “intermediation”;
- SHP development will need to leverage funds from many sources including those for small enterprise development, livelihood development, technical assistance social infrastructure, as well as the more usual energy and environment sources;
- SHP will need to widen the menu of financing options for acquiring both debt and equity, including leasing, novel forms of debt guarantee, and novel forms of collateral;
- Loan conditions should be simplified, and collateral conditions modified to suit local conditions for asset (land, equipment) ownership;
- Some financial institutions are likely to require training to understand the special needs and risks of SHP, or to build on analogous experience in other forms of rural investment.

3.2.5.6. Cash flow analysis and implementation schedule

Cash flow refers to the movement of cash into or out of a project. It is usually measured during a specified, finite period of time. Measurement of cash flow can be used to determine a project's rate of return or value. The time of cash flows into and out of projects are used as inputs in financial models such as internal rate of return and net present value. Cash flow analysis will consist of two countervailing parts- the outflows (basically, the estimated costs: feasibility study, project design and management, civil works, electromechanical equipment, installation, unforeseen expenses, the operation and maintenance cost per year, etc.) and expected inflows (returns) over the years.

Exhaustive list of estimates required for Cash Flow analysis are: a pre-determined Discount Rate, year wise expected realisation of revenues/ returns from water charges and lifetime of the project.

A pre-determined Discount Rate. The need for discount rate arises in calculating the Cost Benefit Ratio and calculation of shadow prices. The costs and returns will occur in streams over different years. To make them comparable they need to be discounted to present values (PV). Different options are available for the discount rate- the interest rate prevailing in the country, the open market rate on borrowing for public investment, or a combination of spot and additional implies the difference between the output of the 'with' the project scenario and 'without' the project scenario. forward interest rates. Market rates are often distorted by the imperfections of financial market. The choice will depend on the real opportunity cost of capital to the society (society has a lower rate of discount or time preference) or the rate of return on capital to the economy (i.e. creation of GDP).

Year wise expected realisation of revenues/ returns from water charges. Since commend area development may be spread over many years, the ratio of irrigated land to total cropped land will gradually rise. Only these fractions of realisation and the target area should be forecasted to get the year wise probable additional revenue series.

Lifetime of the project. The year up to which the scheme is expected to operate viably (both technically and economically) needs to be specified at the outset. After 30 or 40 years the present values of returns become very small.

In the text below two examples of cash flow analysis will be presented: if the investment is not (Appendix A) or is externally financed (Appendix B).

In Appendix C financial analysis of real schemes in Europe is presented.

3.2.5.7. Unit cost of energy

The economic viability should be presented by means of the unit cost of energy (\$/kWh), It is therefore likely that the client will have their own hurdle rate in which the project must provide a minimum return for it to be considered eligible for implementation.

It is necessary aware of the annual cost of energy, including loan payments and maintenance and repair costs, of SHP project and compare that cost with the cost of energy from a diesel generator or from a nearby transmission line.

3.2.5.8. Sensitivity and risk analysis

A sensitivity and risk analysis should be performed to test against the base case for various changes in capital cost, revenue price and annual energy production. The risk assessment should consider the project holistically including construction and operational considerations.

All economic forecasting involves uncertainty. So the designer of the project must make every effort to minimise the uncertainty and make every possible allowance for risks. There are two types of risks. Natural risks arise from the hazards of the weather that may cause fluctuation in water supply and crop yields. Probability calculations in hydrological surveys show that drought could occur in one or two or even three consecutive years. In calculations of average yields, it must be borne in mind that in about one year out of ten no more than 70% of the normal yield may be expected, but a total crop failure is unlikely. With the help of statistical methods (Arithmetic Mean) it is possible to calculate reasonable average yields on the basis of the known climate of the area and the actual yields achieved by the farms. Also using the past record the probability of risks through unforeseen factors need to be calculated.

Economic risks regarding prices could be estimated. Concurrent technological progress (both productivity raising and input cost reducing) may lead to steady decline in prices as supply exceeds demand. Also the maintenance costs may rise due to high inflation. Since it is very difficult to forecast the scale of probable fluctuations in yields and prices with any accuracy, the only solution is *to test the sensitivity of calculations to these fluctuations*. This may be done by using other parameters than those considered probable in the initial calculation and by finding out what parameter(s) have the strongest effects on the profitability of the projects for a given percentage variation (i.e. increase in investment costs, increase in operation costs, decrease in average yields, price decline and extension of construction and farmers' adaptation periods). So, it is desirable to calculate the upper and lower limit of IRR and Cost-Benefit Ratio. There are some contingent cost items like the cost of complementary afforestation if substantial forest land has been submerged, health safeguards to be incorporated during the construction so as to reduce the incidence of health hazards in the operational phase, preventive measures like spraying of mosquito repellent to prevent water-borne diseases, environmental replenishment measures, etc. The negative impact of them on financial returns will be analysed in the sensitivity analysis as, by nature, they are contingent. The impact of delays in construction due to inter-state disputes over sharing of water, reduction in the project life due to higher than the expected siltation, etc. will be similarly incorporated.

Also the items like the loss of medicinal plants, deltas, disappearance of ports and consequent rise in transportation cost (if any), the opportunity cost of fuels lost in cases of water-lifting, etc will be considered in the sensitivity analysis for the *economic* cost-benefit analysis.

3.2.5.9. Economic life

The economic life is the time during which the project can be operated normally. Economic life – typically 40 years used, but also capital depreciation period for construction costs is 50 years while replacement and renovation of electromechanical equipment is 25 years. Renewal of the main parts of the equipment or capital for repair is needed after that period. An essential factor for the calculations is also an estimation of the construction period of the project. This period can vary in the program from 1 to 5 years, affecting the sum total of money invested in the project.

3.2.5.10. Criteria for decision

The feasibility study allows a detailed assessment of the technical and commercial viability of a scheme to be made. However the decision whether to implement the scheme will be up to the owner, especially if the scheme is economically marginal. The owner must fully understand their project and business drivers, as the decision to implement may consider intangible benefits. Based upon experience an appropriate criterion for selection should consider:

- The scheme would need to be technically feasible, but of simple arrangement with appropriate risk mitigation and containment in place;
- Easy to implement;
- Robust;
- Cost effective/cheap;
- Environmentally and socially sound and sustainable.

3.2.6. Implementation and development of a small hydro power plant

Small hydropower development is of relatively complex nature that requires careful consideration of the implementation process to ensure the development risk is effectively managed: based on experience as an owner/developer and consultant/contractor, recommendation is that the plant may be embedded within local communities, which will require appropriate operational considerations and constraints. SHP can often expose owners and developers to risks that far exceed the project's direct commercial indices due to the scale of the projects and their interaction with existing water assets, electricity networks and control systems. While some schemes incorporate a degree of classic design, most are born out of reinvested experience in the design and construction of similar schemes. Often the adoption of arrangements to make use of existing structures and the careful consideration of operational flexibilities within the owner's constraints can make the difference to commercial and technical viability.

There are a number of development options, by means of contract packaging and delivery models which can be adopted for the implementation of SHP. Each model has its own level of risk and reward, which requires the developer to carefully consider the cost risk benefit of the development. Design and construction risks must therefore for carefully

managed to ensure risks are understood and fully considered during construction and long-term operation.

3.2.6.1. Contract packaging models

The contract and commercial packaging for small hydro developments can be considered in a number of ways. Given the need to manage the commercial conditions and the implementation timeframes, it is important that the construction activities and procurement lead-times of equipment are fully understood. Typically the critical path items are the procurement of the turbine and generator.

The contract can be packaged into a number of broad categories, such as:

- Civil package;
- Civil and hydromechanical package;
- Electrical and mechanical package;
- Grid connection package.

The interface or separation points need to be clearly defined to ensure appropriate delivery of design and construction. The open tender process can involve extensive up-front engineering design and specification works to allow all tenderer's to compete on an equal basis, for a defined arrangement and scope of work. Innovation in design would be offered through an alternative or nonconforming tender, and in many cases this would prove successful in reducing the contract cost to allow the project to remain economically viable. Pre-tender consultancies can cost in the order of 10-20% of the value of the contract works for the smaller schemes, and while necessary to determine the feasibility of the scheme, may add limited value to the tender process in achieving the most economical arrangement.

Often, the most economical schemes will be one where the supplier nominates their preferred equipment and standards, and client requirements are then negotiated in. The supplier is in the best position to know the level and standard of equipment required to perform the task, and often tender specifications will only add to the expense of the equipment by specifying standards that may not be warranted by the size of the installation. Some level of specification is always required to define what will finally be delivered, performance criteria and standard of workmanship.

A more streamlined process for the procurement would be to obtain direct quotations from reputable machine suppliers. Usually a maximum of three quotations would be sought, in order to select the most suitable equipment supplier for the works, and that the intention of the design criteria is met. This would also include an interview process of the preferred supplier. Final tender pricing will be prepared based on the final design and outputs, including machine selection and pricing.

3.2.6.2. Contract delivery models

Since any hydro scheme requires a substantial upfront investment, it is clearly essential that the project is implemented correctly and with robust engineering and equipment. Generally, the delivery models for the implementation can be categorized into:

- Turnkey (engineer, procure, construct);
- Partnership (joint venture/alliance);
- Build own operate (BOO).

Figure 3.2.5. presents the delivery models for the SHP implementation.

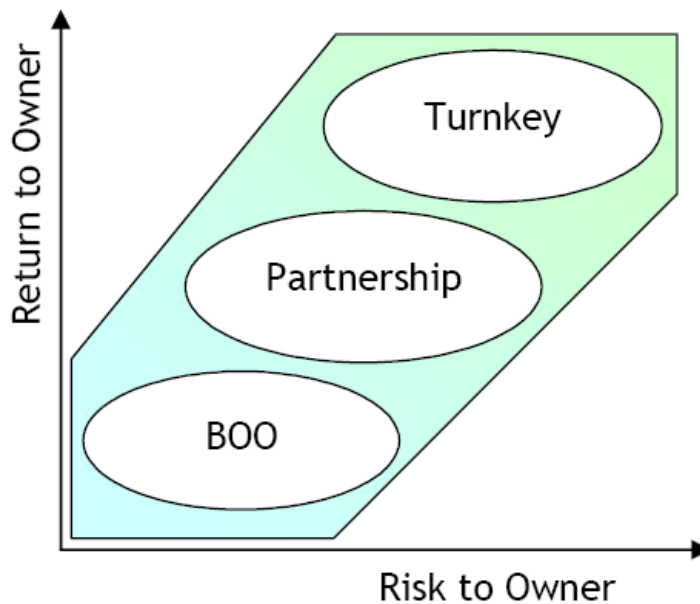

Figure 3.2. 5. The delivery models for the SHP implementation

Turnkey. The most common approach for implementing small hydro projects is the turnkey contract in which a single contractor takes the entire scheme from design to construction, which allows simplification of the management of the project. The contractor, who might be a civil engineering company or the turbine supplier, brings together a team of subcontractors and suppliers under a single contract, typically following a competitive tendering process. Since the main contractor takes the full risk, they have the opportunity to maximise the benefits and revenues.

Partnership. Typically the owner enters into a partnership (alliance) arrangement with another developer and the two parties combine their capabilities to best suit the project. This model ensures that the project is delivered with shared risk and shared benefit.

Build own operate. Under this model the owner sells all rights to the project, and a developer pays for the rights and usually pays an annual royalty for its ownership. Hence, the developer takes the responsibility of the full risk and benefits, in which the owner minimizes their risk and benefit.

3.2.6.3. Financing schemes

Financing of SHP projects is incorporated in the mechanisms of the support and financing of RES. Evidence of RES support are the applicable EU Directives and resulting national development plans. Financial support of RES comes from both private and public sources. The range of finance fluctuates from macro to micro-scale, depending on project size, as in the case of home-based and micro hydro stations.

Recently, more and more banks are interested in financing RES projects, as this is seen as a good business opportunity. A significant role is played by bank institutions, with the European Investment Bank and the European Bank for Reconstruction and Development (EBRD) as examples of such institutions in the EU. Financial support also comes from different kinds of organisations and government agencies, e.g. the German Development Finance Group (KfW). In 2004, the KfW managed about 180 million euro for RES

development. In this case, the German government allots about 500 million euro to the KfW for RES support in the developing countries. In the case of smaller investments, some financial support for RES can be expected from various non-government organisations (e.g. industrial networks, private foundations). A good example is the Renewable Energy Policy Network (RENV21). There are also other financial instruments of great importance such as grants, subsidies, preferences, facilities and taxes. These instruments may depend on local or regional conditions.

Conditions of financing when creating a financial plan for SHP, the following should be taken into consideration:

- large costs of hydro-technical infrastructure,
- project lifetime of SHP is longer than period of capital return.

In the case of SHP, a major cost component can be the preparation of project documentation and the feasibility study - this can even amount to 50% of the costs. In the project, inexpensive and typical solutions should be applied. The contractor may have a substantial cost impact, so this must be fully authorised. The investment loans of 60-80% of the project value may be granted, and they come mainly from government institutions. The projects are often co-financed by local institutions, industry, and financial institutions interested in long-term financing.

Most investors do not have sufficient resources for project investment. Due to the high risk of investment, the cost of acquired capital can be expensive. It may be obtained from several sources, which can also increase the costs. Because this is regarded as a high risk investment, banks may require additional guarantees or special supervision of the development process. In some cases, a consumer loan is also possible. The period of capital return on investment is estimated to be 10 to 20 years, and up to 10 years in the case of commercial banks. The key to success is a properly prepared project, including an accurate estimation of future revenues.

3.2.7 DESCRIPTION of RETScreen® users' software

For technical-economic analysis of the Small Hydro Power Project FSBUZ uses RETScreen® users' software. Due to this chapter describes the analysis of potential small hydro projects using the RETScreen® International Clean Energy Project Analysis Software, including a technology background and a detailed description of the algorithms found in the RETScreen® Software. A collection of project case studies, with assignments, worked-out solutions and information about how the projects fared in the real world, is available at the RETScreen® International Clean Energy Decision Support Centre Website www.retscreen.net.

The RETScreen® International Small Hydro Project Model can be used world-wide to easily evaluate the energy production, life-cycle costs and greenhouse gas emissions reduction for central-grid, isolated-grid and off-grid small hydro projects, ranging in size from multiturbine small and mini hydro installations to single-turbine micro hydro systems.

The RETScreen Small Hydro Project Model provides a means to assess the available energy at a potential small hydro site that could be provided to a central-grid or, for isolated loads, the portion of this available energy that could be harnessed by a local electric utility (or used by the load in an off-grid system). The model addresses both run-of-river and reservoir developments, and it incorporates sophisticated formulae for calculating efficiencies of a wide variety of hydro turbines.

The Small Hydro model can be used to evaluate small hydro projects typically classified under the following three names:

- Small hydro;
- Mini hydro; and
- Micro hydro.

The Small Hydro Project Model has been developed primarily to determine whether work on the small hydro project should proceed further or be dropped in favour of other alternatives. Each hydro site is unique, since about 75% of the development cost is determined by the location and site conditions. Only about 25% of the cost is relatively fixed, being the cost of manufacturing the electromechanical equipment.

Seven worksheets (*Energy Model, Hydrology Analysis and Load Calculation (Hydrology & Load), Equipment Data, Cost Analysis, Greenhouse Gas Emission Reduction Analysis (GHG Analysis), Financial Summary and Sensitivity and Risk Analysis (Sensitivity)*) are provided in the Small Hydro Project Workbook file.

The *Energy Model, Hydrology & Load* and *Equipment Data* worksheets are completed first. The *Cost Analysis* worksheet should then be completed, followed by the *Financial Summary* worksheet. The *GHG Analysis* and *Sensitivity* worksheets are optional analysis. The *GHG Analysis* worksheet is provided to help the user estimate the greenhouse gas (GHG) mitigation potential of the proposed project. The *Sensitivity* worksheet is provided to help the user estimate the sensitivity of important financial indicators in relation to key technical and financial parameters. In general, the user works from top-down for each of the worksheets. This process can be repeated several times in order to help optimise the design of the small hydro project from an energy use and cost standpoint.

The RETScreen Small Hydro Project Model provides the user with two different methods for estimating project costs: the “Formula” and the “Detailed” costing methods. All the hydro cost equations used in the “Formula” costing method are empirical, based on data collected over 20 years for both large and small hydro facilities. They have been extended to include more site data for this analysis. If used correctly, the “Formula” costing method will provide a baseline, or minimum, cost estimate for a proposed project.

The “Detailed” costing method allows the user to estimate costs based on estimated quantities and unit costs. The use of this costing method requires that the user estimate the size and the layout of the required structures. If the user chooses to use this method, the results should be compared with results from the “Formula” costing method. In order to use the RETScreen Small Hydro Project Model, the user may require certain information that can be obtained from available topographic maps. Topographic maps can be purchased or ordered from most map stores. In cases where a previous hydrologic assessment has been undertaken for the site in question, the pertinent data from this assessment can be used in the model. The user should be aware that if the available head, or drop in elevation, at a site is unknown, a site visit will be required to measure the head unless detailed mapping is available. The measurement of head can be done easily using simple surveying techniques.

The various algorithms used to calculate, on an annual basis, the energy production of small hydro power plants in RETScreen are described. A flowchart of the algorithms is shown in Figure 3.2.6.

User inputs include the flow-duration curve and, for isolated-grid and off-grid applications, the load-duration curve. Turbine efficiency is calculated at regular intervals on the flow-duration curve. Plant capacity is then calculated and the power-duration curve is established. Available energy is simply calculated by integrating the power-duration curve. In the case of a central-grid, the energy delivered is equal to the energy available. In the case of an isolated-grid or off-grid application, the procedure is slightly more complicated and involves both the power-duration curve and the load-duration curve. The Formula Costing Method is described in detail in Appendix E. A validation of the RETScreen Small Hydro Project Model is presented in chapter 3.2.7.5.

There are some limitations associated with the Small Hydro Project Model. First, the model has been designed primarily to evaluate run-of-river small hydro projects. The evaluation of storage projects is possible, however, a number of assumptions are required. Variations in gross head due to changes in reservoir water level cannot be simulated. The model requires a single value for gross head and, in the case of reservoir projects, an appropriate average value must be entered. The determination of the average head must be done outside of the model and will require an understanding of the effects of variations in head on annual energy production. Second, for isolated-grid and off-grid applications in isolated areas, the energy demand has been assumed to follow the same pattern for every day of the year. For isolated locations where energy demand and available energy vary significantly over the course of a year, adjustments will have to be made to the estimated amount of renewable energy delivered. This is done by changing the “Available flow adjustment factor” in the Energy Model worksheet. These limitations aside, the model is fairly easy to understand and use. As will be seen in the next sections, the model condenses in an easy-to-use format a wealth of

information, and it should be of great assistance to engineers involved in the preliminary evaluation of small hydro projects.

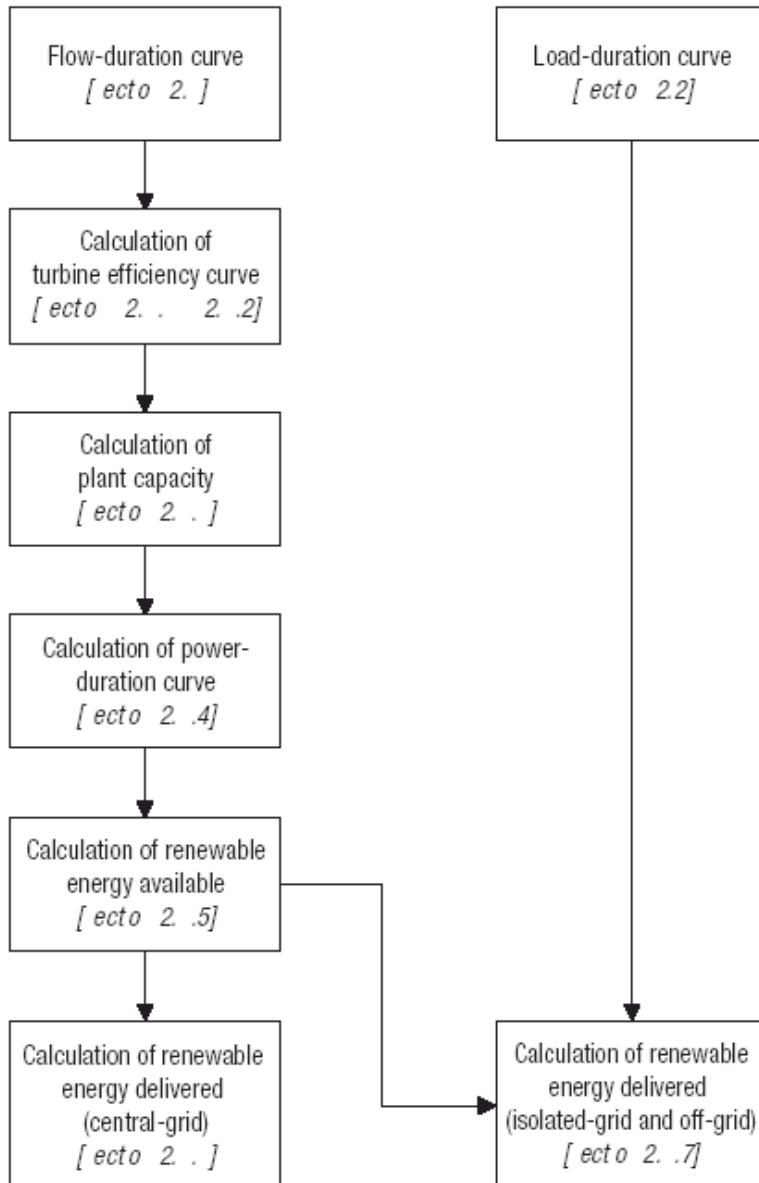

Figure 3.2.6 Small Hydro Energy Model Flowchart

3.2.7.1 Hydrology

In RETScreen, hydrological data are specified as a flow-duration curve, which is assumed to represent the flow conditions in the river being studied over the course of an average year. For storage projects, data must be entered manually by the user and should represent the regulated flow that results from operating a reservoir; at present, the head variation with storage drawdown is not included in the model. For run-of-river projects, the required flow-duration curve data can be entered either manually or by using the specific run-off method and data contained in the RETScreen Online Weather Database.

A flow-duration curve is a graph of the historical flow at a site ordered from maximum to minimum flow. The flow-duration curve is used to assess the anticipated availability of flow over time, and consequently the power and energy, at a site. The model then calculates the firm flow that will be available for electricity production based on the flow-duration curve data, the percent time the firm flow should be available and the residual flow.

3.2.7.1.1 Flow-duration curve

The flow-duration curve is specified by twenty-one values Q_0, Q_5, \dots, Q_{100} representing the flow on the flow-duration curve in 5% increments. In other words, Q_n represents the flow that is equalled or exceeded $n\%$ of the time. An example of a flow-duration curve is shown in Figure 3.2.7.

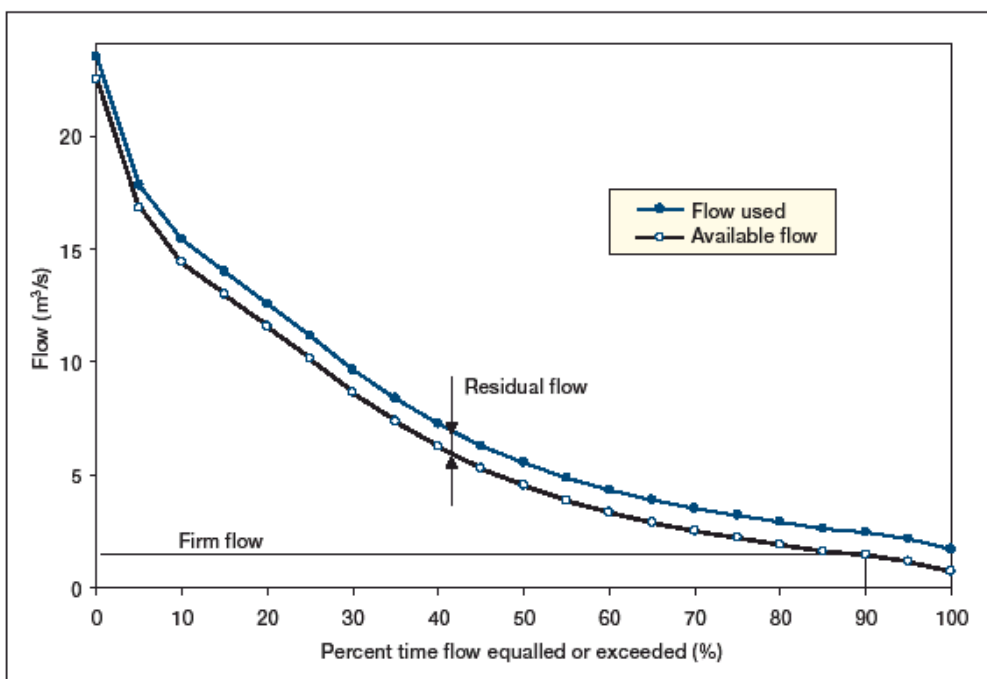

Figure 3.2.7 Example of a Flow-Duration Curve

When the specific run-off method is used, the flow-duration curve is expressed in normalized form, i.e. relative to the mean flow. The mean flow \bar{Q} is calculated as:

$$\bar{Q} = RA_D, \quad [3.2.7]$$

where R is the specific run-off and A_D is the drainage area. Then the actual flow data Q_n ($n = 0, 5, \dots, 100$) is computed from the normalised flow data q_n extracted from the weather database through:

$$Q_n = q_n \bar{Q}. \quad [3.2.8]$$

3.2.7.1.2 Available flow

Often, a certain amount of flow must be left in the river throughout the year for environmental reasons. This residual flow Q_r is specified by the user and must be subtracted from all values of the flow-duration curve for the calculation of plant capacity, firm capacity and renewable energy available, as explained further on in this chapter. The available flow Q_n' ($n = 0, 5, \dots, 100$) is then defined by:

$$Q_n' = \max(Q_n - Q_r, 0) \quad [3.2.9]$$

The available flow-duration curve is shown in Figure 3.2.7, with as an example Q_r set to 1 m³/s.

3.2.7.1.3 Firm flow

The firm flow is defined as the flow being available $p\%$ of the time, where p is a percentage specified by the user and usually equal to 95%. The firm flow is calculated from the available flow-duration curve. If necessary, a linear interpolation between 5% intervals is used to find the firm flow. In the example of Figure 3.2.7, the firm flow is equal to 1.5 m³/s with p set to 90%.

3.2.7.2 Load

The degree of sophistication used to describe the load depends on the type of grid considered. If the small hydro power plant is connected to a central-grid, then it is assumed that the grid absorbs all of the energy production and the load does not need to be specified. If on the other hand the system is off-grid or connected to an isolated-grid, then the portion of the energy that can be delivered depends on the load. The RETScreen Small Hydro Project Model assumes that the daily load demand is the same for all days of the year and can be represented by a load-duration curve. An example of such a curve is shown in Figure 3.2.8. As for the flow-duration curve, the load-duration curve is specified by twenty-one values L_0, L_5, \dots, L_{100} defining the load on the load-duration curve in 5% increments: L_k represents the load that is equalled or exceeded $k\%$ of the time.

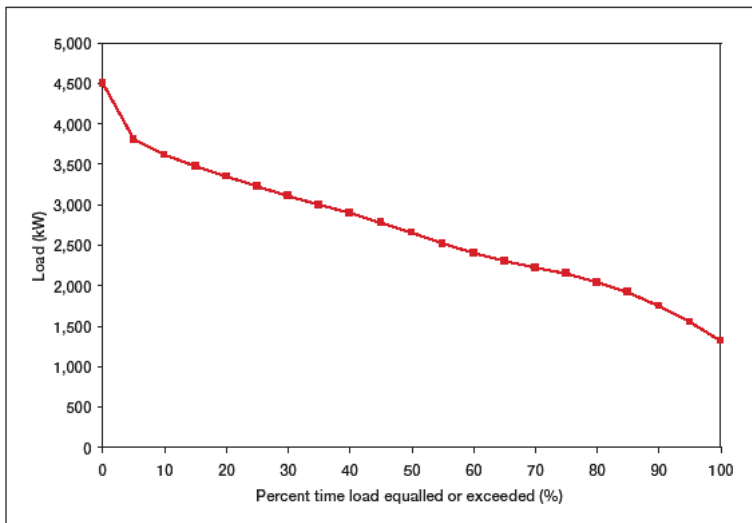

Figure 3.2.8 Example of a Load-Duration Curve.

3.2.7.2.1 Energy demand

Daily energy demand is calculated by integrating the area under the load-duration curve over one day. A simple trapezoidal integration formula is used. The daily demand D_d expressed in kWh is therefore calculated as:

$$D_d \sum_{k=1}^{20} \left(\frac{L_{5(k-1)} + L_{5k}}{2} \right) \frac{5}{100} 24, \quad [3.2.10]$$

with the L expressed in kW. The annual energy demand D is obtained by multiplying the daily demand by the number of days in a year, 365:

$$D = 365D_d . \quad [3.2.11]$$

3.2.7.2.2 Average load factor

The average load factor \bar{L} is the ratio of the average daily load ($D_d/24$) to the peak load (L_0):

$$\bar{L} = \frac{D_d / 24}{L_0} . \quad [3.2.12]$$

This quantity is not used by the rest of the algorithm but is simply provided to the user to give an indication of the variability of the load.

3.2.7.3 Energy Production

The RETScreen Small Hydro Project Model calculates the estimated renewable energy delivered (MWh) based on the adjusted available flow (adjusted flow-duration curve), the design flow, the residual flow, the load (load-duration curve), the gross head and the efficiencies/losses. The calculation involves comparing the daily renewable energy available to the daily load-duration curve for each of the flow-duration curve values.

3.2.7.3.1 Turbine efficiency curve

Small hydro turbine efficiency data can be entered manually or can be calculated by RETScreen. Calculated efficiencies can be adjusted using the *Turbine manufacture/design coefficient* and *Efficiency adjustment* factor in the *Equipment Data* worksheet of the model. Standard turbine efficiencies curves have been developed for the following turbine types:

- Kaplan (reaction turbine);
- Francis (reaction turbine);
- Propellor (reaction turbine);
- Pelton (impulse turbine);
- Turgo (impulse turbine);
- Cross-flow (generally classified as an impulse turbine).

The type of turbine is selected based on its suitability to the available head and flow conditions. The calculated turbine efficiency curves take into account a number of factors including rated head (gross head less maximum hydraulic losses), runner diameter (calculated), turbine specific speed (calculated for reaction turbines) and the turbine manufacture/design coefficient. The efficiency equations were derived from a large number of manufacture efficiency curves for different turbine types and head and flow conditions.

The turbine efficiency equations are described in Appendix D.

For multiple turbine applications it is assumed that all turbines are identical and that a single turbine will be used up to its maximum flow and then flow will be divided equally between two turbines, and so on up to the maximum number of turbines selected. The turbine efficiency equations and the number of turbines are used to calculate plant turbine efficiency from 0% to 100% of design flow (maximum plant flow) at 5% intervals. An example turbine efficiency curve is shown in Figure 3.2.9 for 1 and 2 turbines.

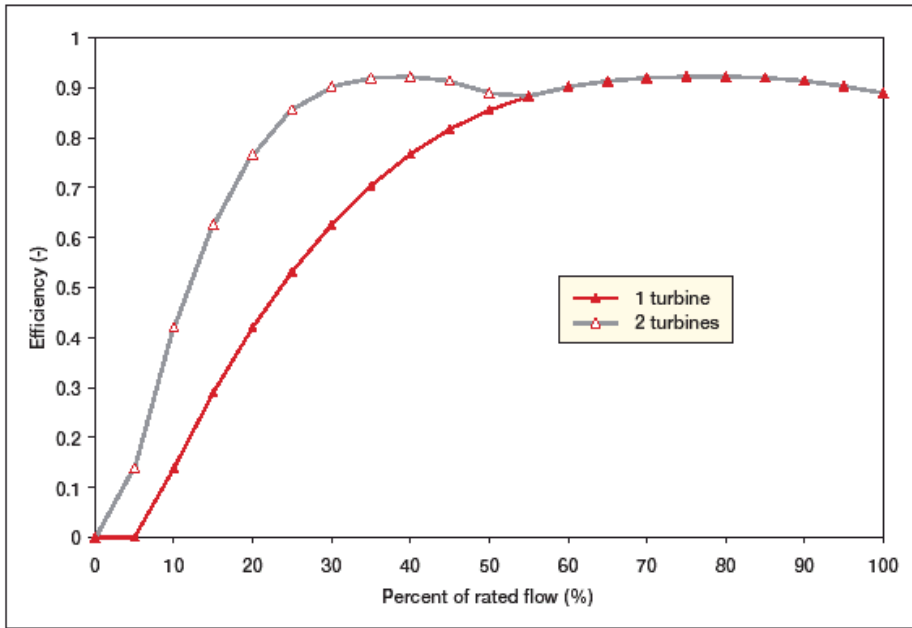

Figure 3.2.9 – Calculated Efficiency Curves for Francis Turbine (Gross Head = 146 m; Design Flow = 1.90 m³/s)

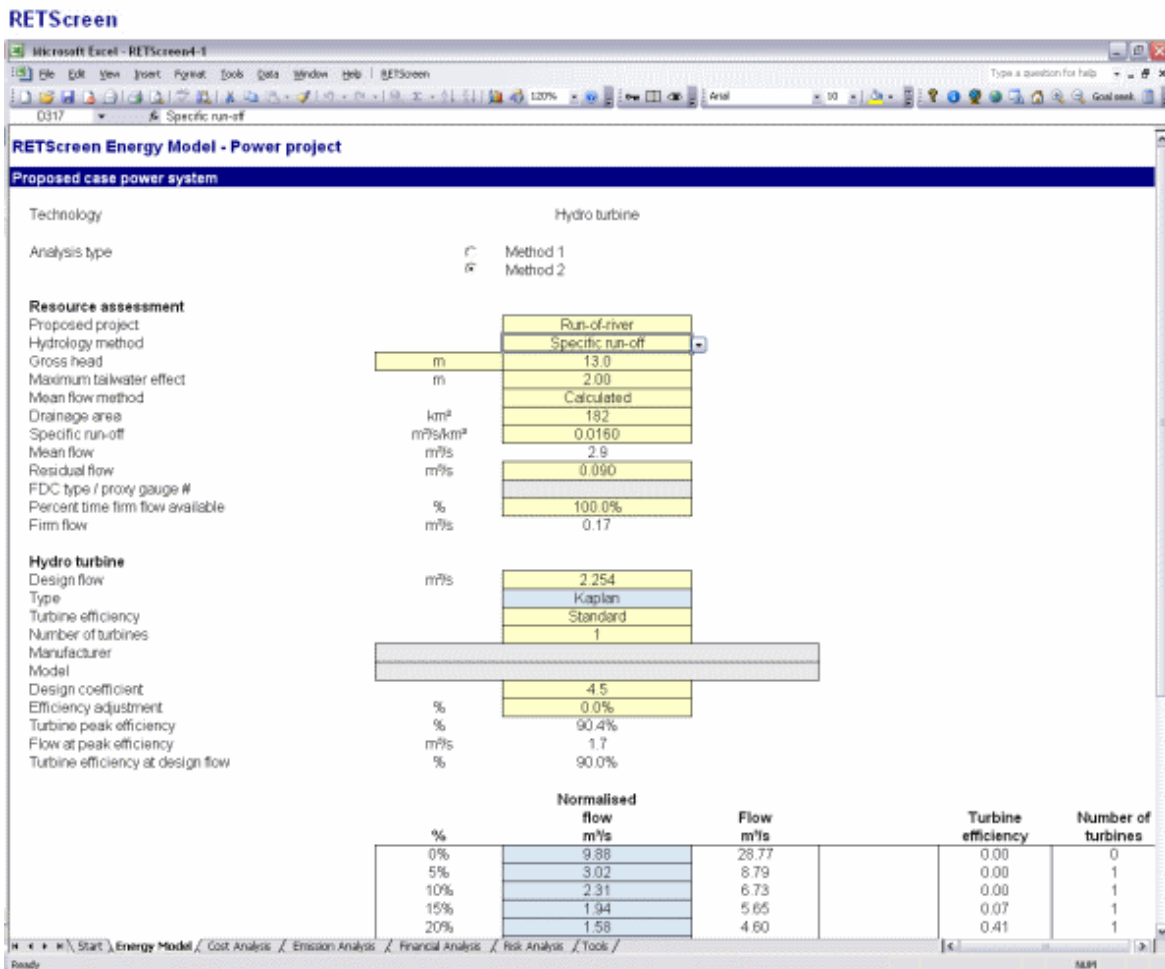

Figure 3.2.10 – Energy Model RetScreen Layout

3.2.7.3.2 Power available as a function of flow

Actual power P available from the small hydro plant at any given flow value Q is given by the following equation, in which the flow-dependent hydraulic losses and tailrace reduction are taken into account:

$$P = \rho g Q [H_g - (h_{hydr} + h_{tail})] e_t e_g (1 - l_{trans}) (1 - l_{para}), \quad [3.2.13]$$

where ρ is the density of water (1,000 kg/m³), g the acceleration of gravity (9.81 m/s²), H_g the gross head, h_{hydr} and h_{tail} are respectively the hydraulic losses and tailrace effect associated with the flow; and e_t is the turbine efficiency at flow Q , calculated as explained in Section 6.3.2. Finally, e_g is the generator efficiency, l_{trans} the transformer losses, and l_{para} the parasitic electricity losses; e_g , l_{trans} , and l_{para} are specified by the user in the *Energy Model* worksheet and are assumed independent from the flow considered, Figure 3.2.10.

Hydraulic losses are adjusted over the range of available flows based on the following relationship:

$$h_{hydr} = H_g l_{hydr,max} \frac{Q^2}{Q_{des}^2}, \quad [3.2.14]$$

where $l_{hydr,max}$ is the maximum hydraulic losses specified by the user, and Q_{des} the design flow. Similarly the maximum tailrace effect is adjusted over the range of available flows with the following relationship:

$$h_{tail} = h_{tail,max} \frac{(Q - Q_{des})^2}{(Q_{max} - Q_{des})^2}, \quad [3.2.15]$$

where $h_{tail,max}$ is the maximum tailwater effect, i.e. the maximum reduction in available gross head that will occur during times of high flows in the river. Q_{max} is the maximum river flow, and equation 3.2.15 is applied only to river flows that are greater than the plant design flow (i.e. when $Q > Q_{des}$).

3.2.7.3.3 Plant capacity

Plant capacity P_{des} is calculated by re-writing equation 3.2.13 at the design flow Q_{des} . The equation simplifies to:

$$P_{des} = \rho g Q_{des} H_g (1 - l_{hydr}) e_{t,des} e_g (1 - l_{trans}) (1 - l_{para}), \quad [3.2.16]$$

where P_{des} is the plant capacity and $e_{t,des}$ the turbine efficiency at design flow, calculated as explained in Section 6.3.2.

The small hydro plant firm capacity is calculated again with equation 3.2.13, but this time using the firm flow and corresponding turbine efficiency and hydraulic losses at this flow. If the firm flow is greater than the design flow, firm plant capacity is set to the plant capacity calculated through equation 3.2.16.

3.2.7.3.4 Power-duration curve

Calculation of power available as a function of flow using equation 3.2.13 for all 21 values of the available flow $Q_0', Q_5', \dots, Q_{100}'$ used to define the flow-duration curve, leads to 21 values of available power P_0, P_5, \dots, P_{100} defining a power-duration curve. Since the design flow is defined as the maximum flow that can be used by the turbine, the flow values used in equations 3.2.13 and 14 are actually $Q_{n,used}$ defined as:

$$Q_{n,used} = \min(Q_n', Q_{des}). \quad [3.2.17]$$

An example power-duration curve is shown in Figure 3.2.11, with the design flow equal to 3 m³/s.

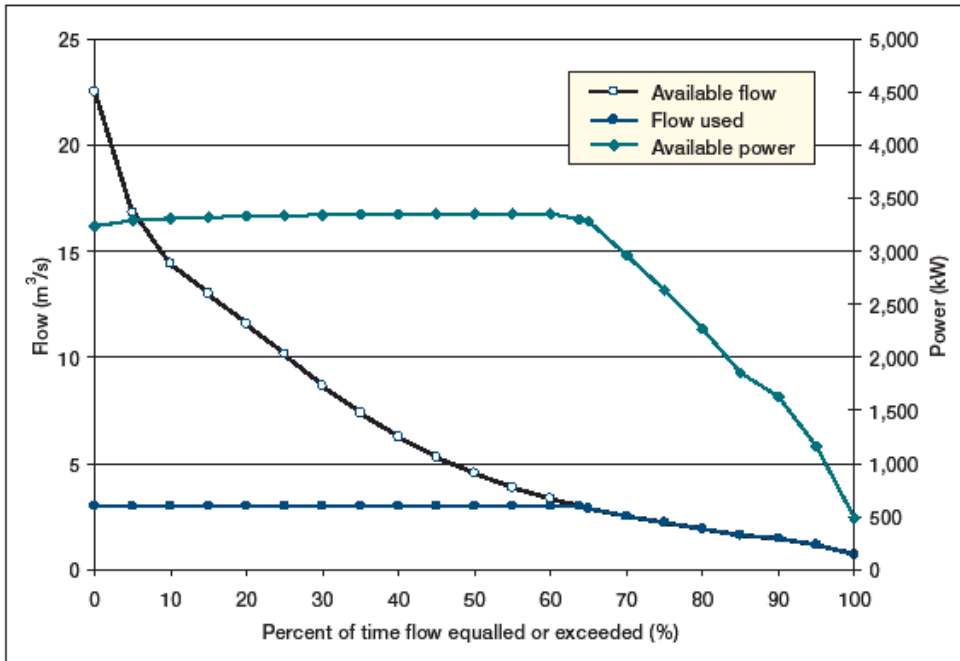

Figure 3.2.11 – Example of a Power-Duration Curve

3.2.7.3.5 Renewable energy available

Renewable energy available is determined by calculating the area under the power curve assuming a straight-line between adjacent calculated power output values. Given that the flow-duration curve represents an annual cycle, each 5% interval on the curve is equivalent to 5% of 8,760 hours (number of hours per year). The annual available energy E_{avail} (in kWh/yr) is therefore calculated from the values P (in kW) by:

$$E_{avail} = \sum_{k=1}^{20} \left(\frac{P_{5(k-1)} + P_{5k}}{2} \right) \frac{5}{100} 8760 (1 - l_{dt}), \quad [3.2.18]$$

where l_{dt} is the annual downtime losses as specified by the user. In the case where the design flow falls between two 5% increments on the flow-duration curve (as in Figure 3.2.9) the interval is split in two and a linear interpolation is used on each side of the design flow. Equation 3.2.18 defines the amount of renewable energy available. The amount actually delivered depends on the type of grid, as is described in the following sections.

3.2.7.3.6 Renewable energy delivered - central-grid

For central-grid applications, it is assumed that the grid is able to absorb all the energy produced by the small hydro power plant. Therefore, all the renewable energy available will be delivered to the central-grid and the renewable energy delivered, E_{dld} , is simply:

$$E_{dld} = E_{avail} \cdot \quad [3.2.19]$$

3.2.7.3.7 Renewable energy delivered - isolated-grid and off-grid

For isolated-grid and off-grid applications the procedure is slightly more complicated because the energy delivered is actually limited by the needs of the local grid or the load, as specified by the load-duration curve (Figure 3.2.8). The following procedure is used: for each 5% increment on the flow-duration curve, the corresponding available plant power output (assumed to be constant over a day) is compared to the load-duration curve (assumed to

represent the daily load demand). The portion of energy that can be delivered by the small hydro plant is determined as the area that is under both the load-duration curve and the horizontal line representing the available plant power output. Twenty-one values of the daily energy delivered G_0, G_5, \dots, G_{100} corresponding to available power P_0, P_5, \dots, P_{100} are calculated. For each value of available power P_n , daily energy delivered G_n is given by:

$$G_n = \sum_{k=1}^{20} \left(\frac{P'_{n,5(k-1)} - P'_{n,5k}}{2} \right) \frac{5}{100} 24, \quad [3.2.20]$$

where $P_{n,k}'$ is the lesser of load L_k and available power P_n :

$$P'_{n,k} = \min(P_n, L_k) \quad [3.2.21]$$

In the case where the available power $P_{n,k}'$ falls between two 5% increments on the load-duration curve, the interval is split in two and a linear interpolation is used on each side of the available power.

The procedure is illustrated by an example, using the load-duration curve from Figure 3.2.8 and values from the power-duration curve shown in Figure 3.2.11. The purpose of the example is to determine the daily renewable energy G_{75} delivered for a flow that is exceeded 75% of the time. One first refers to Figure 3.2.11 to determine the corresponding power level:

$$P_{75} = 2,630 \text{ kW}. \quad [3.2.22]$$

Then one reports that number as a horizontal line on the load-duration curve, as shown in Figure 3.2.12. The area that is both under the load-duration curve and the horizontal line is the renewable energy delivered per day for the plant capacity that corresponds to flow Q_{75} ; integration with formula 3.2.20 gives the result:

$$G_{75} = 56.6 \text{ MWh/d}. \quad [3.2.23]$$

The procedure is repeated for all values P_0, P_5, \dots, P_{100} to obtain twenty one values of the daily renewable energy delivered G_0, G_5, \dots, G_{100} as a function of percent time the flow is exceeded as shown in Figure 3.2.13. The annual renewable energy delivered E_{dvd} is obtained simply by calculating the area under the curve of Figure 3.2.13, again with a trapezoidal rule:

$$E_{dvd} = \sum_{n=1}^{20} \left(\frac{G_{5(n-1)} + G_{5n}}{2} \right) \frac{5}{100} 365(1 - l_{dt}), \quad [3.2.24]$$

where, as before, l_{dt} is the annual downtime losses as specified by the user.

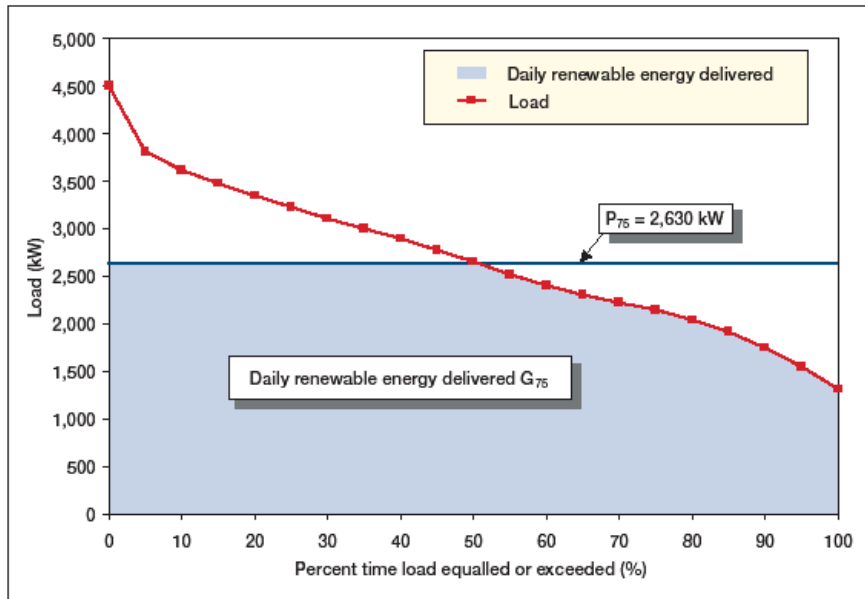

Figure 3.2.12 – Example of Calculation of Daily Renewable Energy Delivered

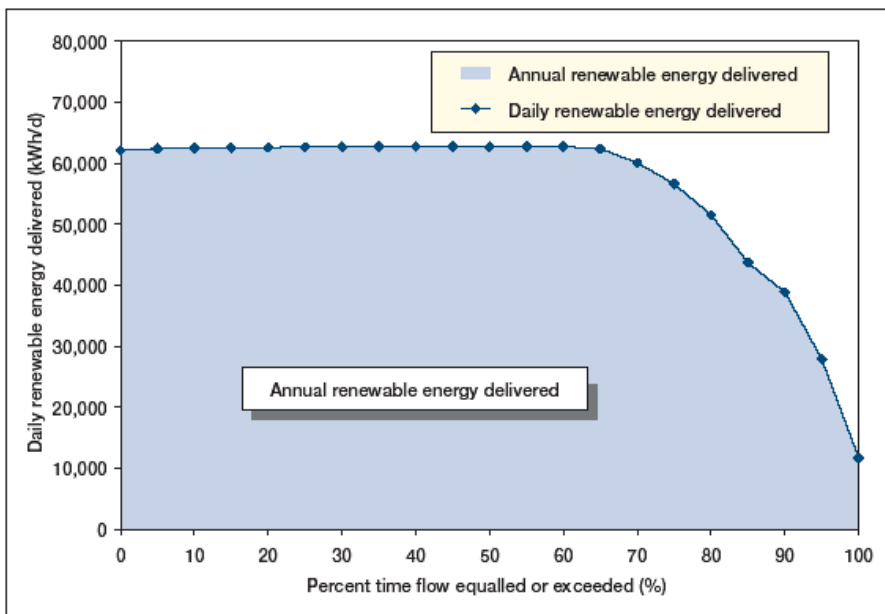

Figure 3.2.13 – Example of Calculation of Annual Renewable Energy Delivered

3.2.7.3.8 Small hydro plant capacity factor

The annual capacity factor K of the small hydro power plant is a measure of the available flow at the site and how efficiently it is used. It is defined as the average output of the plant compared to its rated capacity:

$$K = \frac{E_{dvd}}{8760P_{des}}, \quad [3.2.25]$$

where the annual renewable energy delivered E_{dvd} calculated through Equation 3.2.19 or 3.2.24 is expressed in kWh, and plant capacity calculated through Equation 3.2.16 is expressed in kW.

3.2.7.3.9 Excess renewable energy available

Excess renewable energy available E_{excess} is the difference between the renewable energy available E_{avail} and the renewable energy delivered E_{dvd} :

$$E_{excess} = E_{avail} - E_{dvd} \quad [3.2.26]$$

E_{avail} is calculated through equation 3.2.18 and E_{dvd} through either Equation 3.2.25 or 3.2.30.

3.2.7.4 Project Costing

The Small Hydro Project Model is unique among RETScreen technology models in that it offers two methods for project costing: the detailed costing method, or alternatively, the formula costing method.

The detailed costing method is described in the online user manual. The formula costing method is based on empirical formulae that have been developed to relate project costs to key project parameters. The costs of numerous projects have been used to develop the formulae. The formulas are described in *Appendix E*.

3.2.7.5 Validation

Numerous experts have contributed to the development, testing and validation of the RETScreen Small Hydro Project Model. They include small hydro modelling experts, cost engineering experts, greenhouse gas modelling specialists, financial analysis professionals, and ground station (hydrology) and satellite weather database scientists.

This section presents three examples of the validations completed. In Chapter 3.2.7.5.1, a turbine efficiency curve as calculated by RETScreen is compared to manufacturer's efficiency data for an installed unit with the same characteristics. Then, the annual renewable energy delivered and plant capacity calculated by RETScreen are compared to values calculated by another software program in Chapter 3.2.7.5.2. And finally, project costs, as calculated by the formula costing method, are compared to the as-built costs of one small hydro project in Chapter 3.2.7.5.3.

3.2.7.5.1 Turbine efficiency

Small hydro turbine efficiency as calculated by RETScreen was compared to the manufacturer guaranteed turbine efficiency for the Brown Lake Hydro Project in British Columbia, Canada.

The following provides a summary of the Brown Lake project and the turbine performance data as provided by the manufacturer:

Project name:

Brown Lake Hydro Project

Project location:

Approximately 40 km south of Prince Rupert, British Columbia on the confluence of Brown Creek and Ecstall River.

Project features:

600 m rock tunnel tapping into Brown Lake, 50 m of 1.5 m diameter steel penstock, single horizontal Francis turbine, horizontal synchronous generator, 1,500 m of submarine power cable, substation and connection to BC Hydro at 69 kV. Automatic operation and remote monitoring.

Date commissioned:

December 1996

Turbine manufacturer:

GEC Alsthom (runner by Neyrpic)

Turbine type:

Francis

Nameplate rating:

6,870 kW at 103.6 m net head

Maximum rated power:

7,115 kW at 105.6 m net head

RPM:

514

Diameter:

1,100 mm

Number of blades:

13

Efficiency data:

(see Figure 3.2.14)

Flow (m ³ /s)	Efficiency
7.35	0.93
7.00	0.93
6.65	0.93
6.30	0.92
5.95	0.91
5.60	0.90
5.25	0.90
4.90	0.88
4.55	0.87
4.20	0.85
3.85	0.84
3.50	0.82

Figure 3.2.14 Manufacturer's Turbine Efficiency Data

A gross head value of 109.1 m was entered into RETScreen, which corresponds to a net head of 103.6 m with maximum hydraulic losses of 5%. Comparison between the manufacturer's efficiency data and the efficiency curve generated by RETScreen is shown in Figure 3.2.15. As illustrated in the figure, the RETScreen calculated efficiency curve provides a good approximation of the as-designed turbine efficiencies.

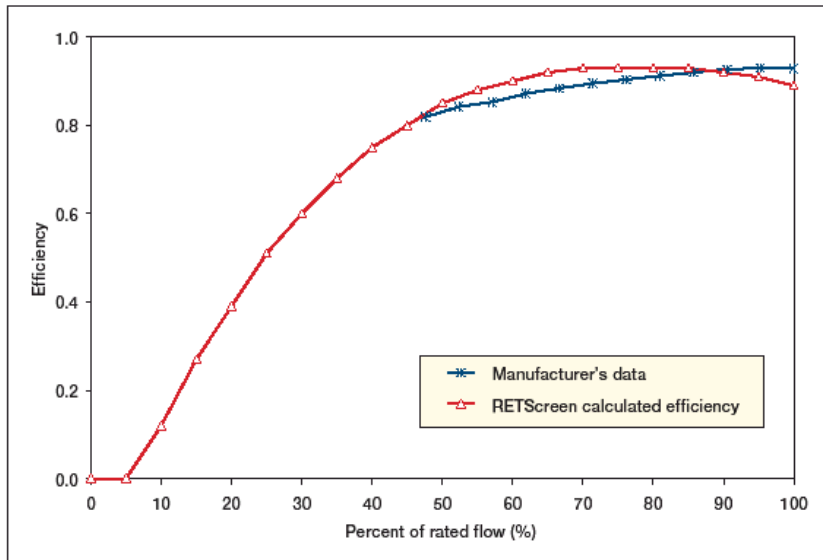

Figure 3.2. 15 – Comparison of RETScreen Calculated Hydro Turbine Efficiency against Manufacturer's Data

Note that detailed on-site index testing would be required to verify the manufacturer's as-designed efficiency curve. Accurate index tests are very costly and not normally undertaken for small hydro projects unless there is sufficient concern that the turbine is not performing as designed. An index test would likely yield some differences in the shape of the manufacturer's efficiency curve.

3.2.7.5.2 Plant capacity and annual renewable energy delivered

A comparison between the RETScreen Small Hydro Project Model and another software program called HydrA is presented in a report for the International Energy Agency – Implementing Agreement for Hydropower Technologies and Programmes entitled "Assessment Methods for Small-hydro Projects", dated April 2000. HydrA is a software package used to estimate the hydropower potential at any location in the United Kingdom or Spain. HydrA incorporates a regional flow estimation model derived from extensive statistical analysis of national river flow data and catchment information. The following is extracted from the report.

Comparison of the RETScreen5 and HydrA energy analyses was made for a Scottish catchment where the HydrA-derived flow-duration curve was entered in RETScreen, Figure 3.2.16. The standard generic efficiency curves in both programs were left unchanged, although these differ to some extent. Rated flow and residual flows [sic] were made the same.

The resulting annual energy values were obtained:

Mean flow: 1.90 m³/s
 Residual flow: 0.27 m³/s
 Rated turbine flow: 1.63 m³/s
 Gross hydraulic head: 65.0 m
 Net hydraulic head: 58.5 m

Applicable Turbines	Gross Annual Av. Output MWh	Net Annual Av. Output MWh	Maximum Power Output kW	Rated Capacity kW	Minimum Operational Flow m ³ /s
RETScreen					
Francis		3 092		819.0	
Crossflow		2 936		745.0	
Turgo		3 125		758.0	
HydrA					
Francis	3 270.3	3 107	858.7	824.4	0.76
Crossflow	3 072.7	2 919	748.3	700.5	0.51
Turgo	3 163.1	3 005	809.1	728.2	0.43

Figure 3.2. 16 – Comparison of RETScreen and HydrA calculations

It may be concluded from this simple test that there is little difference in the energy calculations.

3.2.7.5.3 Project costs

Project costs as calculated by RETScreen using the Formula Costing Method were compared to a detailed as-built cost evaluation prepared for the existing 6 MW Rose Blanche hydroelectric development in Newfoundland, Canada.

The key parameters of the Rose Blanche project are summarised below:

Project name:

Rose Blanche Hydroelectric Development

Owner/developer:

Newfoundland Power

Project location:

Rose Blanche Brook, approximately 45 km east of Channel Port Aux Basques.

Date commissioned:

December 1998

Project type:

Run-of-river (with several days' storage)

Installed capacity:

6 MW

Design net head:

114.2 m

Rated flow:

6.1 m³/s

Turbine/generator:

Twin Francis turbines connected to a single generator.

Other project features:

Small dam with minimal storage, 1,300 m penstock, short transmission line (approximately 3 km).

The data inputs for the RETScreen Formula Costing Method and the results are shown in Figure 3.2.17, and a comparison of the costs as calculated by RETScreen and the detailed cost evaluation for the real project is presented in Figure 3.2.18. The detailed project costs estimated in 1998 have been converted to 2000 values using an inflation factor of 1.03.

RETScreen® Cost Analysis - Small Hydro Project

Costing method: **Formula** Currency: **\$** Cost references: **None**

Formula Costing Method	Notes/Range
Input Parameters	
Project country	Canada
Cold climate?	yes/no Yes
Frost days at site	day 200 See Man West/WAS4 emb/W4_data.xls
Number of turbines	turbine 2
Flow per turbine	m³/s 3.1
Approx. turbine runner diameter (per unit)	m 0.8
Project classification:	
Suggested classification	- Mini
Selected classification	- Small
Existing dam?	yes/no No
New dam crest length	m 200.0
Rock at dam site?	yes/no Yes
Maximum hydraulic losses	% 5%
Intake and miscellaneous losses	% 1%
Access road required?	yes/no Yes
Length	km 5.0
Tote road only?	yes/no No
Difficulty of terrain	- 3.0
Tunnel required?	yes/no No
Canal required?	yes/no No
Penstock required?	yes/no Yes
Length	m 1,300.0
Number of identical penstocks	penstock 1
Allowable penstock headloss factor	% 4.0%
Pipe diameter	m 1.61
Average pipe wall thickness	mm 8.1
Distance to borrow pits	km 3.0
Transmission line	
Length	km 5.0
Difficulty of terrain	- 1.0
Voltage	kV 44.0
Interest rate	% 9.0%

Initial Costs (Formula Method)	Cost (local currency)	Adjustment Factor	Amount (local currency)	Relative Costs
Feasibility Study	\$ 504,000	1.00	\$ 504,000	3.1%
Development	\$ 529,000	1.00	\$ 529,000	3.3%
Land rights			\$ 0.0%	
Development Sub-total:			\$ 529,000	3.3%
Engineering	\$ 537,000	1.00	\$ 537,000	3.3%
Energy Equipment	\$ 3,032,000	1.00	\$ 3,032,000	18.6%
Balance of Plant				
Access road	\$ 1,096,000	1.00	\$ 1,096,000	6.7%
Transmission line	\$ 217,000	1.00	\$ 217,000	1.3%
Substation and transformer	\$ 175,000	1.00	\$ 175,000	1.1%
Penstock	\$ 1,831,000	1.00	\$ 1,831,000	11.3%
Canal	\$ -	1.00	\$ -	0.0%
Tunnel	\$ -	1.00	\$ -	0.0%
Civil works (other)	\$ 6,326,000	1.00	\$ 6,326,000	38.9%
Balance of Plant Sub-total:			\$ 9,645,000	59.3%
Miscellaneous				
	\$ 2,015,000	1.00	\$ 2,015,000	12.4%
GHG baseline study and MP	Cost \$ -		\$ -	0.0%
GHG validation and registration	Cost \$ -		\$ -	0.0%
Miscellaneous Sub-total:			\$ 2,015,000	12.4%
Initial Costs - Total (Formula Method)	\$ 16,282,000		\$ 16,282,000	100.0%

Figure 3.2.17 – Cost Analysis Worksheet for Rose Blanche Hydroelectric Project

The RETScreen Formula Costing Method calculated total cost is approximately 14% higher than the detailed project cost evaluation for the real project. The RETScreen estimate, however, includes a cost for the feasibility study, which is not part of the detailed cost estimate.

If the feasibility cost is deducted from the RETScreen estimate, the difference in results reduces to 11% (RETScreen results being 11% higher than the detailed cost estimate). For the RETScreen Formula Costing Method the project classification was selected as “small” to represent the higher design and construction standards that would normally be attributable to projects designed and constructed by a large utility. If the recommended project classification of “mini” were used, and the feasibility study cost removed, the RETScreen estimate would be approximately 9% lower than the detailed cost evaluation.

<u>Rose Blanche Hydroelectric Development, Newfoundland, Canada</u>					
RETScreen Formula Costing Method			(1)		Detailed Project Costs
Initial Costs (Formula Method)	Cost (local currency)	Adjustment Factor	Amount (local currency)	(2)	Variance (1)/(2)
Feasibility Study	\$ 504,000	1.00	\$ 504,000	\$ -	
Development	\$ 529,000	1.00	\$ 529,000	\$ 463,500	114%
Land rights			\$ -	\$ -	
Development Sub-total:			\$ 529,000	\$ 463,500	114%
Engineering	\$ 537,000	1.00	\$ 537,000	\$ 878,800	61%
Energy Equipment	\$ 3,032,000	1.00	\$ 3,032,000	\$ 2,729,800	111%
Balance of Plant					
Access road	\$ 1,096,000	1.00	\$ 1,096,000	\$ 957,900	114%
Transmission line	\$ 217,000	1.00	\$ 217,000	\$ 372,860	58%
Substation and transformer	\$ 175,000	1.00	\$ 175,000	\$ 539,720	32%
Penstock	\$ 1,831,000	1.00	\$ 1,831,000	\$ 3,090,000	59%
Canal	\$ -	1.00	\$ -	\$ -	
Tunnel	\$ -	1.00	\$ -	\$ -	
Civil works (other)	\$ 8,326,000	1.00	\$ 8,326,000	\$ 4,351,750	145%
Balance of Plant Sub-total:	\$ 9,645,000		\$ 9,645,000	\$ 9,312,230	104%
Miscellaneous	\$ 2,015,000	1.00	\$ 2,015,000	\$ 821,940	245%
GHG baseline study and MP	Cost \$ -		\$ -	\$ -	
GHG validation and registration	Cost \$ -		\$ -	\$ -	
Miscellaneous Sub-total:			\$ 2,015,000	\$ 821,940	245%
Initial Costs - Total (Formula Method)	\$ 16,262,000		\$ 16,262,000	\$ 14,292,670	114%

Figure 3.2.18 – Comparison of Costs Calculated Using RETScreen Formula Method vs. Detailed Project Costs.

While there are some discrepancies in the details between the two cost estimates, overall the totals correspond well. Some of the discrepancies could be explained by a different cost categorisation that was used for the detailed evaluation (grouping of certain categories of the detailed estimate were required in order to match the RETScreen categories). The accuracy of the cost estimate by the RETScreen Small Hydro Project Model Formula Costing Method is nevertheless sufficient at the pre-feasibility stage of a study.

3.2.8. References

The following literature is used:

- [1] W. Bobrowicz, *Power Quality and Utilisation Guide, Section 8: Distributed Generation, Small Hydro Power - Investor Guide*, Koncern Energetyczny SA, 2006.
- [2] M. Kane *et al*, *Statewide Small Hydropower Resource Assessment*, Navigant Consulting, Inc., 2006.
- [3] M. Morgenroth, F.Welt & H.W. de Meel, *Economic risk assessment for hydro plants using computer software*, 2008.
- [4] *STANDARDS / MANUALS / GUIDELINES FOR SMALL HYDRO DEVELOPMENT, CIVIL WORKS, GUIDELINES FOR LAYOUT OF SMALL HYDRO PLANTS*, LEAD ORGANIZATION: ALTERNATE HYDRO ENERGY CENTRE INDIAN INSTITUTE OF TECHNOLOGY, ROORKEE
- [5] G. Stojmirovic, T. Chu, *A Practical Guide to Assessment and Implementation of Small Hydropower*, Hydro Tasmania Consulting, Tasmania, Australia.
- [6] *Guide on How to Develop a Small Hydropower Plant*, European Small Hydropower Association – ESHA.
- [7] S.M.H. Hosseini, F. Forouzbakhshb, M. Rahimpour, *Determination of the optimal installation capacity of small hydro-power plants through the use of technical, economic and reliability indices*, Energy Policy 33 (2005) 1948–1956.
- [8] J.K. Kaldellis, D.S. Vlachou, G. Korbakis, *Techno-economic evaluation of small hydro power plants in Greece: a complete sensitivity analysis*, Energy Policy 33 (2005) 1969–1985.
- [9] *A GUIDE TO UK MINI-HYDRO DEVELOPMENTS*, The British Hydropower Association, January 2005
- [10] S.K. Singal and R.P. Saini, *Analytical Approach for Cost Estimation of Low Head Small Hydro Power Schemes*, Alternate Hydro Energy Centre, Indian Institute of Technology, Roorkee, India.
- [11] www.smallhydropower.com
- [12] <http://nwda.gov.in/writereaddata/linkimages/104.pdf>
- [13] <http://citeseerx.ist.psu.edu/viewdoc/summary?doi=10.1.1.128.5432>
- [14] *Feasibility Analysis in Small Hydropower Planning*, US Army Corps of Engineers, Hydrologic Engineering Center.
- [15] <http://www.spd.usace.army.mil/cwpm/public/plan/pdguide/guide.htm>
- [16] www.retscreen.net

APPENDIX A: Example: The investment is not externally financed

Table A1. The baseline data for cash flow analysis

Installed capacity:	4 929 kW
Estimated annual output	15 750 MWh
The estimated cost of the project:	
1) Feasibility study	€6100
2) Project design and management	€151 975
3) Civil works	€2 884 500
4) Electromechanical equipment	€2 686 930
5) Installation	€686 930
Sub-Total	€6 416 435
6) Unforeseen expenses (3%)	€192 493
Total investment	€6 608 928
The investment cost per installed kW	$6\,608\,928 / 4\,929 = 1\,341 \text{ €/kW}$
The investment cost per annual MWh produced	420 €/MWh
The operation and maintenance cost per year (4% of the total investment)	€264 357
First year annual revenue	€1 005 320
Discount rate - r	8%
Lifetime - n	35 years
Description of a project:	
<p>In the analysis, it is assumed that the project will be developed in four years. The first year will be devoted to the feasibility study and to the planning and consents process. Hence, at the end of first year, both the entire feasibility study cost and half the cost of project design and management will be spent. At the end of second year the other half of the design and project management costs will be spent. At the end of the third year 60% of the civil works will be finished and 50% of the electromechanical equipment paid for. At the end of the fourth year the whole development is finished and paid. The scheme is commissioned at the end of the fourth year and becomes operative at the beginning of the fifth (year zero). The electricity revenues and the O&M costs are made effective at the end of each year. The electricity prices increases by one point less than the inflation rate. The abstraction license duration has been fixed at 35 years, starting from the beginning of the second year (year -2). The discount rate is 8% and the residual value nil. Table .2 shows the cash flows along the project lifetime. It is assumed that the price of the electricity will increase every year one point less than the inflation rate.</p>	

Table A2. Cash flow analysis

Year	Investment	Revenues	O&M	Cash Flow	Cumulated Cash Flow
-4		82 087		- 82 087	- 82 087
-3		75 988		- 75 988	- 158 075
-2		3 074 165		-3 074 165	-3 232 240
-1		3 376 688		-3 376 688	-6 608 928
0	1 005 320		264 357	740 963	-5 867 965
1	995 267		264 357	730 910	-5 137 055
2	985 314		264 357	720 957	-4 416 098
3	975 461		264 357	711 104	-3 704 995
4	965 706		264 357	701 349	-3 003 645
5	956 049		264 357	691 692	-2 311 953
6	946 489		264 357	682 132	-1 629 821
7	937 024		264 357	672 667	- 957 155
8	927 654		264 357	663 297	- 293 858
9	918 377		264 357	654 020	360 162
10	909 193		264 357	644 836	1 004 998
11	900 101		264 357	635 744	1 640 743
12	891 100		264 357	626 743	2 267 486
13	882 189		264 357	617 832	2 885 318
14	873 368		264 357	609 010	3 494 329
15	864 634		264 357	600 277	4 094 605
16	855 988		264 357	591 630	4 686 236
17	847 428		264 357	583 071	5 269 306
18	838 953		264 357	574 596	5 843 903
19	830 564		264 357	566 207	6 410 109
20	822 258		264 357	557 901	6 968 010
21	814 036		264 357	549 679	7 517 689
22	805 895		264 357	541 538	8 059 227
23	797 836		264 357	533 479	8 592 706
24	789 858		264 357	525 501	9 118 207
25	781 959		264 357	517 602	9 635 809
26	774 140		264 357	509 783	10 145 592
27	766 398		264 357	502 041	10 647 633
28	758 734		264 357	494 377	11 142 011
29	751 147		264 357	486 790	11 628 800
30	743 636		264 357	479 278	12 108 079
31	736 199		264 357	471 842	12 579 921
32	728 837		264 357	464 480	13 044 401

Net Present Value (NPV)

Equation 3.2.5 can be written as follows:

$$NPV = \sum_{t=4}^{36} \frac{R_t - (O_t + M_t)}{(1+r)^t} - \sum_{t=0}^3 \frac{I_t}{(1+r)^t}$$

To calculate the above equation it should be taken into account that R_t varies every year because of change in electricity price. Calculating the equation manually or using the NPV value from an electronic spreadsheet, the NPV obtained is: **€444 803**

Internal Rate of Return (IRR)

The IRR is computed using an iterative calculation process, using different discount rates to get the one that makes $NPV = 0$, or using the function IRR in an electronic spreadsheet.

NPV using $r = 8\%$: $NPV = €444\ 803$

NPV using $r = 9\%$: $NPV = €40\ 527$

Following the iteration and computing NPV , when the discount rate $r = 8.91\%$ then the NPV is zero and consequently $IRR = 8.91\%$

Ratio Benefit/Cost

The NPV at year 35 of the revenues is €8 365 208 and the NPV at year 35 of the costs is €7 884 820. This gives:

$$R_{b/c} = 1.061$$

Varying the assumptions can be used to check the sensitivity of the parameters. Table A3 and Table A illustrate respectively the NPV and $R_{b/c}$, corresponding to the example A, for several life times and several discount rates.

Table A3. NPV against discount rate and lifetime

Yr./r	6%	8%	10%	12%
25	1 035 189	21 989	- 668 363	-1 137 858
30	1 488 187	281 347	- 518 242	-1 050 050
35	1 801 647	444 803	- 431 924	-1 003 909

Table A4. $R_{b/c}$ against discount rate and lifetime

Yr./r	6%	8%	10%	12%
25	1.153	1.020	0.906	0.811
30	1.193	1.050	0.930	0.830
35	1.215	1.061	0.933	0.828

The financial results are very dependent on the price paid for the electricity. Table A5 gives the values NPV , $R_{b/c}$ and IRR for different tariffs – 35% and 25% lower and 15% and 25% higher than that assumed in example A

Table A5. NPV , $R_{b/c}$ and IRR for different tariffs (were r is 8% and the period is 35 years)

65%	75%	100%	115%	125%	
NPV	-2 266 144	-1 491 587	444 803	1 606 638	2 381 194



**Policies, Methodologies & Tools to
Improve the Exploitation of SHP**
3.2 FBUZ, & Karlovac County Croatia

APPENDIX
Page 53 of 73

<i>B/C</i>	0.690	0.796	1.061	1.220	1.326
<i>IRR</i>	2.67%	4.68%	8.91%	11.16%	12.60%

APPENDIX B: Example: The investment is externally financed

Table B1. The baseline data for cash flow analysis

Discount rate	8%
Development time	4 years
Finance period	12 year
Bank interest rate	10%
Project lifetime	Project lifetime 30 years
Description of a project:	
Payments and expenses at the end of the year. Approximately 70% of the investment financed by the bank with two years grace. The disbursements are identical as in example A. The bank in the first two years collects only the interest on the unpaid debt. It must be remarked that the example refers to a hypothetical scheme, although costs and revenues are reasonable in Southern Europe. The objective is to illustrate a practical case to be followed and later applied to another scheme with different costs and revenues.	

Table B2. Annual cash flows for externally financed investment

Investment cost - €	O&M costs - €	Discount rate	Lifetime - t	Bank loan	Loan term - yr.	Interest on loan	NPV	$R_{b/c}$	IRR
6 608 928	264 357	8%	35 yr.	4 515 599	12	10%	208 208	1.061	8.72%

Yr	Investment	Bank loan	Investor's investment	Principal repayment	Principal residual	Interest on loan	Revenues	O&M	Investor Cash Flow	Cumulated Cash Flow
-4	- 82 087								- 82 087	- 82 087
-3	- 75 988								- 75 988	- 158 075
-2	-3 074 165	-2 151 916	- 922 249	0	-2 151 916				- 922 249	-1 080 324
-1	-3 376 688	-2 363 683	-1 013 005	0	-4 515 599	- 215 192			-1013 005	-2 093 329
0				0	-4 515 599	- 451 560	1 005 320	- 264 357	289 403	-1 803 926
1				- 135 023	-4 380 576	- 451 560	995 267	- 264 357	144 327	-1 659 599
2				- 296 835	-4 083 741	- 438 058	985 314	- 264 357	- 13 936	-1 673 535
3				- 326 519	-3 757 222	- 408 374	975 461	- 264 357	- 23 789	-1 697 324
4				- 359 171	-3 398 051	- 375 722	965 706	- 264 357	- 33 544	-1 730 868
5				- 395 088	-3 002 963	- 339 805	956 049	- 264 357	- 43 201	-1 774 069
6				- 434 596	-2 568 367	- 300 296	946 489	- 264 357	- 52 761	-1 826 829
7				- 478 056	-2 090 311	- 256 837	937 024	- 264 357	- 62 226	-1 889 055
8				- 525 862	-1 564 449	- 209 031	927 654	- 264 357	- 71 597	-1 960 652
9				- 578 448	- 986 001	- 156 445	918 377	- 264 357	- 80 873	-2 041 525
10				- 636 293	- 349 708	- 98 600	909 193	- 264 357	- 90 057	-2 131 582
11				- 349 708	0	- 34 971	900 101	- 264 357	251 066	-1 880 516
12							891 100	- 264 357	626 743	-1 253 773
13							882 189	- 264 357	617 832	- 635 940
14							873 368	- 264 357	609 010	- 26 930
15							864 634	- 264 357	600 277	573 347
16							855 988	- 264 357	591 630	1 164 977
17							847 428	- 264 357	583 071	1 748 048
18							838 953	- 264 357	574 596	2 322 644
19							830 564	- 264 357	566 207	2 888 851
20							822 258	- 264 357	557 901	3 446 752
21							814 036	- 264 357	549 679	3 996 430
22							805 895	- 264 357	541 538	4 537 968



**Policies, Methodologies & Tools to
Improve the Exploitation of SHP**
3.2 FBUZ, & Karlovac County Croatia

23		797 836	- 264 357	533 479	5 071 448
24		789 858	- 264 357	525 501	5 596 948
25		781 959	- 264 357	517 602	6 114 551
26		774 140	- 264 357	509 783	6 624 333
27		766 398	- 264 357	502 041	7 126 375
28		758 734	- 264 357	494 377	7 620 752
29		751 147	- 264 357	486 790	8 107 542
30		743 636	- 264 357	479 278	8 586 820
31		736 199	- 264 357	471 842	9 058 662
32		728 837	- 264 357	464 480	9 523 142

APPENDIX C: FINANCIAL ANALYSIS

Table C1: Financial analysis of real schemes in Europe

Country		Germany	France	Ireland	Portugal	Spain
Rated discharge	m ³ /s	0.3	0.6	15	2	104
Gross head	m	47	400	3.5	117	5
Type of Turbine		Francis	Pelton	Kaplan	Francis	Kaplan
Installed capacity	kW	110	1900	430	1630	5000
Investment cost	€	486 500	1297 400	541 400	1148 000	5578 928
Working hours		8 209	4 105	8 400	4 012	3 150
Annual production	MWh	903	7800	3612	6540	15750
Tariff	€/MWh	76.13	53.65	23.23	53.54	63.82
Revenue	€/Yr	68 745	418 443	83 907	350 128	1005 165
O&M	€/Yr	19 850	51 984	25 176	22 960	157 751
O&M	%	4.08	4.01	4.65	2.00	2.83
Gross Profit	€/Yr	48 895	366 459	58 731	327 168	847 414
Economic Analysis						
Capital cost	€/kW	4 423	683	1 259	704	1 116
Capital cost	€/MWh	539	166	150	176	354
Simple payback period	Yr.	9.95	3.54	9.22	3.51	6.58
NPV	€	63 374	2 649 850	115 910	2 375 270	3 739 862
IRR	%	9.37	28.23	10.33	28.49	14.99
B/C		1.15	2.72	1.16	2.82	1.64

The figures have been calculated using a discount rate of 8% over a lifetime of 30 years. You can see that ratios of investment per kW installed, or by annual MWh, produced differ considerably from scheme to scheme. Actual civil works, electromechanical equipment costs varies from country to country. Environmental requirements - affecting investment costs- differ not only from country to country but also from region to region. Buy-back electricity tariffs can be five times higher in one country than in another.

APPENDIX D: TURBINE EFFICIENCY FORMULAE

<i>FRANCIS, KAPLAN AND PROPELLOR TURBINES (REACTION TURBINES):</i>	
ITEM	FORMULA
Reaction turbine runner size (d)	$d = kQ_d^{0.473}$ <p>where: d = runner throat diameter in m k = 0.46 for $d < 1.8$ = 0.41 for $d \geq 1.8$ Q_d = design flow (flow at rated head and full gate opening in m³/s)</p>
Specific speed (n_q)	$n_q = kh^{-0.5}$ <p>where: n_q = specific speed based on flow k = 800 for propeller and Kaplan turbines = 600 for Francis turbines h = rated head on turbine in m (gross head less maximum hydraulic losses)</p>

FRANCIS TURBINES:	
ITEM	FORMULA
Specific speed adjustment to peak efficiency (\hat{e}_{nq})	$\hat{e}_{nq} = \left\{ \frac{(n_q - 56)}{256} \right\}^2$
Runner size adjustment to peak efficiency (\hat{e}_d)	$\hat{e}_d = (0.081 + \hat{e}_{nq}) (1 - 0.789d^{-0.2})$
Turbine peak efficiency (e_p)	$e_p = (0.919 - \hat{e}_{nq} + \hat{e}_d) - 0.0305 + 0.005 R_m$ <p>where: R_m = turbine manufacture/design coefficient (2.8 to 6.1; default = 4.5). Refer to online manual.</p>
Peak efficiency flow (Q_p)	$Q_p = 0.65 Q_d n_q^{0.05}$
Efficiencies at flows below peak efficiency flow (e_q)	$e_q = \left\{ 1 - \left[1.25 \left(\frac{(Q_p - Q)}{Q_p} \right)^{(3.94 - 0.0195n_q)} \right] \right\} e_p$
Drop in efficiency at full load (\hat{e}_r)	$\hat{e}_r = 0.0072 n_q^{0.4}$
Efficiency at full load (e_r)	$e_r = (1 - \hat{e}_r) e_p$
Efficiencies at flows above peak efficiency flow (e_q)	$e_q = e_r - \left[\left(\frac{Q - Q_p}{Q_d - Q_p} \right)^2 (e_p - e_r) \right]$

KAPLAN AND PROPELLOR TURBINES:	
ITEM	FORMULA
Specific speed adjustment to peak efficiency (\hat{e}_{nq})	$\hat{e}_{nq} = \left\{ \frac{(n_q - 170)}{700} \right\}^2$
Runner size adjustment to peak efficiency (\hat{e}_d)	$\hat{e}_d = (0.095 + \hat{e}_{nq}) (1 - 0.789d^{-0.2})$
Turbine peak efficiency (e_p)	$e_p = (0.905 - \hat{e}_{nq} + \hat{e}_d) - 0.0305 + 0.005 R_m$ <p>where: R_m = Turbine manufacture/design coefficient (2.8 to 6.1; default 4.5). Refer to online manual.</p>

KAPLAN TURBINES:	
ITEM	FORMULA
Peak efficiency flow (Q_p)	$Q_p = 0.75 Q_d$
Efficiency at flows above and below peak efficiency flow (e_q)	$e_q = \left[1 - 3.5 \left(\frac{Q_p - Q}{Q_p} \right)^6 \right] e_p$

PROPELLOR TURBINES:	
ITEM	FORMULA
Peak efficiency flow (Q_p)	$Q_p = Q_d$
Efficiencies at flows below peak efficiency flow (e_q)	$e_q = \left[1 - 1.25 \left(\frac{Q_p - Q}{Q_p} \right)^{1.13} \right] e_p$

PELTON TURBINES:	
ITEM	FORMULA
Rotational speed (n)	$n = 31 \left(h \frac{Q_d}{j} \right)^{0.5}$ <p>where: j = Number of jets (user-selected value from 1 to 6)</p>
Outside diameter of runner (d)	$d = \frac{49.4 h^{0.5} j^{0.62}}{n}$
Turbine peak efficiency (e_p)	$e_p = 0.864 d^{0.04}$
Peak efficiency flow (Q_p)	$Q_p = (0.662 + 0.001j) Q_d$
Efficiency at flows above and below peak efficiency flow (e_q)	$e_q = \left[1 - \left\{ (1.31 + 0.025j) \left(\frac{Q_p - Q}{Q_p} \right)^{(5.6 + 0.4j)} \right\} \right] e_p$

TURGO TURBINES:	
ITEM	FORMULA
Efficiency (e_q)	Pelton efficiency minus 0.03

<i>CROSS-FLOW TURBINES:</i>	
ITEM	FORMULA
Peak efficiency flow (Q_p)	$Q_p = Q_d$
Efficiency (e_q)	$e_q = 0.79 - 0.15 \left(\frac{Q_d - Q}{Q_p} \right) - 1.37 \left(\frac{Q_d - Q}{Q_p} \right)^{14}$

APPENDIX E: FORMULAE FOR FORMULA COSTING METHOD

VARIABLES LISTED ALPHABETICALLY					
A	Access road difficulty factor	J_t	Higher cost vertical axis turbine factor	n_p	Number of penstocks
B	Foreign costs civil works factor	K	Allowable tunnel head loss (ratio to H_g)	P	Transmission line wood pole vs. steel tower factor
C	Civil cost factor	K	User-defined equipment manufacture cost coefficient to account for country of manufacture	Q	Flow under consideration (m^3/s)
C_g	Lower cost generator factor	K_t	Lower cost small horizontal axis turbine factor	Q_d	Design flow (m^3/s)
C_v	Tunnel volume of concrete lining (m^3)	l_a	Access road length (km)	Q_u	Flow per unit (m^3/s)
d	Runner diameter (m)	l_b	Distance to borrow pits (km)	R	Rock factor
D	Transmission line difficulty factor	L_c	Ratio of the cost of local labour costs compared to Canadian cost expressed as a decimal	R_v	Tunnel volume of rock excavation (m^3)
d_p	Diameter of penstock(s) (m)	l_r	Canal length in rock (m)	S_r	Side slope of rock terrain through which canal will be built (degrees)
E	Engineering cost factor	l_{es}	Canal length in impervious soil (m)	S_s	Side slope of soil terrain through which canal will be built (degrees)
E_c	Ratio of the cost of local construction equipment costs compared to Canadian costs expressed as a decimal	l_d	Dam crest length (m)	T	Tote road factor
f	Frost days at site	l_p	Penstock length (m)	t_{ave}	Average penstock thickness (mm)
F	Frost days factor	l_r	Transmission line length (km)	t_b	Penstock thickness at turbine (mm)
F_c	Ratio of the cost of local fuel costs compared to Canadian costs expressed as a decimal	l_t	Tunnel length (m)	T_c	Tunnel lining length ratio
G	Grid connected factor	MW	Total capacity (MW)	t_t	Penstock thickness at intake (mm)
H_g	Gross head (m)	MW_u	Capacity per unit (MW)	V	Transmission line voltage (kV)
i	Interest rate (%)	n	Number of turbines	W	Penstock weight (steel) (kg)

BASIC PARAMETERS			
ITEM	SMALL	MINI	MICRO
Design flow (maximum flow used by generating station) in m ³ /s (\underline{Q}_d)	User-defined value		
Recommended classification	$\underline{Q}_d > 12.8$	$12.8 \geq \underline{Q}_d > 0.4$	$\underline{Q}_d \leq 0.4$
Selected classification	User-defined value based on acceptable risk (flood, etc.).		
Number of turbines (n)	User-defined value		
Flow per turbine in m ³ /s (\underline{Q}_*)	$= \underline{Q}_d / n$		
Approx. turbine runner diameter in m (d)	$= 0.482 \underline{Q}_*^{0.45}$		
Gross head in m (H_g)	User-defined value		
MW/unit in MW (hidden) (MW_u)	$= 8.22 \underline{Q}_* H_g / 1000$	$= 7.79 \underline{Q}_* H_g / 1000$	$= 7.53 \underline{Q}_* H_g / 1000$
Total Capacity in MW (hidden) (MW)	$= MW_u n$		

OTHER VARIABLES AND COSTING FACTORS (IN ORDER OF USE IN FORMULAE)			
ITEM	SMALL	MINI	MICRO
Engineering cost factor (hidden) (E)		= 0.67 if existing dam = 1.0 if no dam as specified by yes/no selection	
Grid-connected factor to account for the use of induction generators (hidden) (G)		= 0.9 if MW < 1.5 and central-grid connected	
Factor to account for use of lower-cost motors as generators for projects below 10 MW (hidden) (C _g)		= 0.75 if MW < 10 = 1.0 if MW ≥ 10	
Factor to account for cost increase with vertical axis Kaplan, Francis and Propeller units at heads above 25 m (hidden) (J _v)		= 1 if H _h ≤ 25 = 1.1 if H _h > 25	
Factor to account for cost decrease with small horizontal Kaplan, Francis and Propeller axis units (hidden) (K _v)		= 0.9 if d < 1.8 = 1.0 if d ≥ 1.8	
Factor to adjust access road costs to reflect lower-cost tote road construction (hidden) (I)		= 0.25 if tote road = 1.0 otherwise as specified by yes/no selection	
Access road difficulty of terrain factor (A)		User-defined factor with recommended range of 1 to 6	
Length of access road in m (l _a)		User-defined value	

OTHER VARIABLES AND COSTING FACTORS (IN ORDER OF USE IN FORMULAE)			
ITEM	SMALL	MINI	MICRO
Transmission line difficulty of terrain factor (D)	User-defined factor with recommended range of 1 to 2		
Length of transmission line in km (l_t)	User-defined value		
Transmission line voltage in kV (V)	User-defined value		
Factor to reflect cost of wood pole vs. steel tower construction (hidden) (P)	= 0.85 if $V < 69$ = 1.0 if $V \geq 69$		
Civil cost factor (hidden) (C)	= 0.44 if existing dam = 1.0 if no dam as specified by yes/no selection		
Rock factor (hidden) (R)	= 1 if rock at dam site = 1.05 if no rock as specified by yes/no selection		N/A
Distance to a borrow pit in km (l_b)	User-defined value		
Length of dam crest in m (l_d)	User-defined value		
Number of identical penstocks (n_p)	User-defined value		
Weight of penstock(s) in kg (hidden) (W)	Calculated value (penstock cost formula)		
Diameter of penstock(s) in m (d_p)	Calculated value (penstock cost formula)		
Length of penstock(s) in m (l_p)	User-defined value		

OTHER VARIABLES AND COSTING FACTORS (IN ORDER OF USE IN FORMULAE)			
ITEM	SMALL	MINI	MICRO
Average pipe wall thickness of penstock(s) in mm (t_{avc})	Calculated value (penstock cost formula)		
Penstock pipe wall thickness at intake in mm (hidden) (t_i)	Calculated value (penstock cost formula)		
Penstock pipe wall thickness at turbine in mm (hidden) (t_b)	Calculated value (penstock cost formula)		
Terrain side slope of soil through which canal is to be constructed in degrees (S_s)	User-defined value		
Length of canal to be constructed in soil in m (l_{cs})	User-defined value		
Terrain side slope of rock through which canal is to be constructed in degrees (S_r)	User-defined value		
Length of canal to be constructed in rock in m (l_{cr})	User-defined value		
Tunnel rock excavation volume in m ³ (hidden) (R_v)	Calculated value (tunnel cost formula)		N/A
Tunnel concrete lining volume in m ³ (hidden) (C_v)	Calculated value (tunnel cost formula)		N/A
Length of tunnel in m (l_t)	User-defined value		N/A

OTHER VARIABLES AND COSTING FACTORS (IN ORDER OF USE IN FORMULAE)			
ITEM	SMALL	MINI	MICRO
Allowable tunnel headloss expressed as a ratio to the gross head (k)		User-defined value	N/A
Percent length of tunnel that is lined factor (L_c)		User-defined value with recommended range of 15% (excellent rock) to 100% (poor rock)	N/A
Interest rate (i)		User-defined value	
Number of days with frost at site (f)		User-defined value	
Frost-days factor (hidden) (F)		$= \frac{110}{(365 - f)^{0.9}}$	
Local vs. Canadian equipment costs ratio (E_c)		User-defined value	
Local vs. Canadian fuel costs ratio (F_c)		User-defined value	
Local vs. Canadian labour costs ratio (L_c)		User-defined value	
Civil works foreign cost factor (hidden). Used in program to determine local cost of the civil works components of foreign projects (B)		$= (0.3333E_c + 0.3333F_c) \times \frac{1}{\left(\frac{E_c}{L_c}\right)^{0.5} + 0.3333} \left(\frac{E_c}{L_c}\right)^{0.5} L_c$	
Equipment manufacture cost coefficient (K)			User-defined value with recommended range of 0.5 to 1.0

BASIC COSTING FORMULAE				
ITEM	SMALL	MINI	MICRO	
Feasibility study (Eq.#1)	$-0.032 \sum (Eq.\#2) \text{ to } (Eq.\#15)$			
Development (Eq.#2)	$=0.04 \sum (Eq.\#3) \text{ to } (Eq.\#14)$			
Engineering (Eq.#3)	$=0.37 n^{0.54} E \left(\frac{MFW}{H_r^{0.3}} \right)^{10.54} \times 10^6$		$=0.04 \left(\frac{MFW}{H_r^{0.3}} \right)^{10.54} \times 10^6$	
Energy equipment (Eq.#4)	Generator and Control: (all turbine types)	$=0.82 n^{0.96} G C_r \left(\frac{MFW}{H_r^{0.3}} \right)^{0.9} \times 10^6$		
	Kaplan turbine and governor:	$=0.27 n^{0.96} J_r K_r d^{1.43} (1.17 H_r^{0.12} + 2) \times 10^6$		
	Francis turbine and governor:	$=0.17 n^{0.96} J_r K_r d^{1.43} \{ (13 + 0.01 H_r^{0.3})^{0.5} + 3 \} \times 10^6$		
	Propeller turbine and governor:	$=0.125 n^{0.96} J_r K_r d^{1.43} (1.17 H_r^{0.12} + 4) \times 10^6$		
	Pelton/Turgo turbine and governor:	$=3.47 n^{0.94} \left(\frac{MFW}{H_r^{0.3}} \right)^{0.44} \times 10^6$ where $\frac{MFW}{H_r^{0.3}} > 0.4$		
		$=5.34 n^{0.96} \left(\frac{MFW}{H_r^{0.3}} \right)^{0.91} \times 10^6$ where $\frac{MFW}{H_r^{0.3}} \leq 0.4$		
	Cost of Pelton/Turgo $\times 0.5$			
Installation of energy equipment (Eq.#5)	$=0.15$ (Eq.#4)			
Access road (Eq.#6)	$=0.025 T A^2 l_r^{0.9} \times 10^6$			
Transmission line (Eq.#7)	$=0.0011 D P l_r^{0.99} V \times 10^6$			

BASIC COSTING FORMULAE			
ITEM	SMALL	MINI	MICRO
Substation, and transformer (Eq. #8)	$= (0.0025 n^{0.85} + 0.002 (n+1) \times \left(\frac{MW}{H_s} \right)^{0.95} \times V^{0.3} \times 10^6$		
Installation of substation and transformer (Eq. #9)	$= 0.15 \text{ (Eq. #8)}$		
Civil works (Eq. #10)	$= 3.54 n^{-0.04} C R$ $\times \left(\frac{MW}{H_s} \right)^{0.22}$ $\times (1+0.01 I_b)$ $\times \left(1+0.005 \frac{I_d}{H_s} \right)$ $\times 10^6$	$= 1.97 n^{-0.04} C R$ $\times \left(\frac{MW}{H_s} \right)^{0.22}$ $\times (1+0.01 I_b)$ $\times \left(1+0.005 \frac{I_d}{H_s} \right)$ $\times 10^6$	$= 1.97 n^{-0.04} C$ $\times \left(\frac{MW}{H_s} \right)^{0.22}$ $\times \left(1+0.005 \frac{I_d}{H_s} \right)$ $\times 10^6$
Penstock (Eq. #11)	$= 20 n_p^{0.85} W^{0.88}$ <p>where:</p> $W = (24.7 d_p I_p t_{max})$ <p>where:</p> $d_p = \left(\frac{Q_p}{n_p} \right)^{0.43} / H_s^{0.14}$ $t_i = d_p^{1.3} + 6$ $t_b = 0.0375 d_p H_s$ $t_{max} = 0.5(t_i + t_b) \quad \text{if } t_b \geq t_i$ $t_{max} = t_i \quad \text{if } t_b < t_i$		

BASIC PARAMETERS			
ITEM	SMALL	MINI	MICRO
Installation of penstock (Eq.#12)			
Canal (Eq.#13)		$= 5 W^{0.88}$	
		$= 20 \times [(1.5 + 0.01 S_r^{1.5}) Q_d I_{cr}]^{0.9}$ <p style="text-align: center;">(for soil conditions)</p> $+$ $= 100 \times [(1.5 + 0.016 S_r^2) Q_d I_{cr}]^{0.9}$ <p style="text-align: center;">(for rock conditions)</p>	
Tunnel (Eq.#14)	$= 400 R_v^{0.96} + 4000 C_v^{0.94}$ <p style="text-align: center;">where:</p> $R_v = 0.185 i_i^{1.375} \left(\frac{Q_d^2}{k H_r} \right)^{0.375}$ $C_v = 0.306 R_v I_c$		N/A
Miscellaneous (Eq.#15)	$= 0.25 i Q_d^{0.35}$ $\times 1.1 \sum (\text{Eq. \#2}) \text{ to (Eq. \#14)}$ $+ 0.1 \sum (\text{Eq. \#2}) \text{ to (Eq. \#14)}$		$= 0.17 i$ $\times 1.1 \sum (\text{Eq. \#2}) \text{ to (Eq. \#14)}$ $+ 0.1 \sum (\text{Eq. \#2}) \text{ to (Eq. \#14)}$
Initial Costs – Total (Formula Method)	$= \sum (\text{Eq. \#1}) \text{ to (Eq. \#15)}$		

BASIC PARAMETERS			
ITEM	SMALL	MINI	MICRO
Installation of penstock (Eq.#12)	$= 5 W^{0.88}$		
Canal (Eq.#13)	$= 20 \times [(1.5 + 0.01 S_r^{1.5}) Q_d I_{cr}]^{10.9}$ <p style="text-align: center;">(for soil conditions)</p> $+$ $= 100 \times [(1.5 + 0.016 S_r^{1.5}) Q_d I_{cr}]^{10.9}$ <p style="text-align: center;">(for rock conditions)</p>		
Tunnel (Eq.#14)	$= 400 R_v^{0.98} + 4000 C_v^{0.98}$ <p style="text-align: center;">where:</p> $R_v = 0.185 I_v^{1.375} \left(\frac{Q_d^2}{k H_z} \right)^{0.375}$ $C_v = 0.306 R_v T_c$		
Miscellaneous (Eq.#15)	$= 0.17 i$ $\times 1.1 \sum (Eq.\#2) \text{ to } (Eq.\#14)$ $+ 0.1 \sum (Eq.\#2) \text{ to } (Eq.\#14)$		
Initial Costs – Total (Formula Method)	$= \sum (Eq.\#1) \text{ to } (Eq.\#15)$		



CANADIAN AND NON-CANADIAN PROJECTS - APPLICATION OF "F," "B," AND "K" FACTORS						
Costing Category	Canadian Projects		Non-Canadian Projects			
	Apply "F" Factor	% Local Component	Apply "F" to Local	Apply "B" to Local	Apply "K" to Foreign	
Feasibility study (Eq.#1)		15%				
Development (Eq.#2)		50%				
Engineering (Eq.#3)	Yes	40%	Yes		Yes	
Energy equipment (Eq.#4)		0%			Yes	
Installation of energy equipment (Eq.#5)	Yes	100%	Yes	Yes		
Access (Eq.#6)	Yes	100%	Yes	Yes		
Transmission line (Eq.#7)	Yes	60% if V < 69 40% if V ≥ 69	Yes	Yes	Yes	
Substation and transformer (Eq.#8)		0%			Yes	
Installation of substation and transformer (Eq.#9)	Yes	100%	Yes	Yes		
Civil works (Eq.#10)	Yes	85%	Yes	Yes	Yes	
Penstock (Eq.#11)		0%			Yes	
Installation of penstock (Eq.#12)	Yes	100%	Yes	Yes		
Canal (Eq.#13)	Yes	100%	Yes	Yes		
Tunnel (Eq.#14)	Yes	85%	Yes	Yes	Yes	
Miscellaneous (Eq.#15)						



RETScreen FORMULA COSTING METHOD COST CATEGORIES	
Cost Category	Formula(e) number(s)
Feasibility Study	1
Development	2
Engineering	3
Energy Equipment	4
<i>Balance of plant</i>	
Access road	6
Transmission line	7
Substation and transformer	8
Penstock	11
Canal	13
Tunnel	14
Civil works (other)	5 + 9 + 10 + 12
<i>Subtotal</i>	
Miscellaneous	15

SMART
Strategies to Promote Small Scale
Hydro Electricity Production In Europe

WP 3 – Deliverable D3.1
Policies, methodologies & tools that may support decision makers in
implementing Small Scale Hydro Electricity Plants

**Guidelines and Tools for a
Technical and Economic Evaluation of
Small Hydro Electricity Plants construction**

Chapter 3.3 ERSE, Italy





Policies, Methodologies & Tools to Improve the Exploitation of SHP

3.3 ERSE, Italy

Table of contents

Summary -----	3
3.3.1 SHP informatic tools -----	4
3.3.1.1 Vapidro-Aste -----	4
3.3.1.1.1 Available, natural and hydropower flow -----	4
3.3.1.1.2 Potential hydro power calculation -----	7
3.3.1.1.3 Economic feasibility -----	8
3.3.1.1.4 The GIS software tool to evaluate the residual potential hydropower in a watercourse-----	9
3.3.1.2 Smart Mini-Idro -----	14
3.3.1.2.1 Discharge Module -----	15
3.3.1.2.2 Turbine selection Module -----	18
3.3.1.2.3 Energy calculation Module -----	20
3.3.1.2.4 Cost evaluation Module -----	21
3.3.1.2.5 Financial Analysis Module -----	22
3.3.1.3 Hydropower Investor Database Structure -----	25
3.3.1.3.1 Public Cadastre in the internet-----	25

Summary

Chapter 3.3 is the Italian contribution, written by ERSE, to deliverable D3.1 of the European Project named SMART. It describes tools for a technical and economic evaluation of SHP construction. The program tools have been tested on the pilot region and the results are presented in deliverable D4.1 in work package 4 of the SMART project.

Three tools developed by ERSE regarding the evaluation of the hydropower potential, the optimization of the exploitation and the identification of the main financial characteristics of a particular site. Also the investor database of potential sites is described.

VAPIDRO ASTE, a GIS integrated numerical tool that allows for the evaluation of the residual potential hydropower energy and all possible alternatives concerning the sites for hydroelectric plants along the drainage network, taking into account the relationship between the full costs of the mini-hydro power and the benefits from selling the generated power in the national market.

SMART Mini Idro. a tool to evaluate the main hydropower project parameters, considering the flow duration curve, the available heads and the types of turbines to be installed, the range of discharges to be used, etc. The tool calculates the cash flow of the works and it is able to identify the type of turbine to choose.

INVESTOR DATABASE OF POTENTIAL SITES AND HYDROPOWER CADASTRE, The user is able to zoom from national scale, to regional scale up to a County scale, to identify the installed power and quantities of minihydro installations. In collaboration with each Province Administration, the database could be extended dynamically to represent also the asked concession in each zone. The cadastre database is a useful tool that permits the stakeholders to evaluate the possibility to a new hydropower investment, and to know if this possibility is requested or not by other competitors

3.3.1 SHP informatic tools

Three tools developed by ERSE regarding the evaluation of the hydropower potential, the optimization of the exploitation and the identification of the main financial characteristics of a particular site. Also the investor database of potential sites is described.

3.3.1.1 Vapidro-Aste

Tool to evaluate the hydropower residual potential in a water course taking into account the analysis of the catchment, the actual withdrawals and restitutions scheme and the application of the Minimum Instream Flow constrains.

The VAPIDRO-ASTE tool is able to calculate automatically the river network associated to the interesting area. The user chose the a river branch where to calculate the potential hydropower production and then a series of chained sub-basins are generated by the model.

The Tool is able to guide the user to identify the best hydropower configuration, maximizing the energy and minimizing investment costs.

The tool is developed based on the DEM “Digital Elevation Model”, addressed mainly to the support decision makers and stakeholders, for the evaluation of potential sites addressed to the SHP implementation in the territory.

3.3.1.1.1 Available, natural and hydropower flow

In order to analyse the potential small-hydro sites at a river scale, the knowledge of the water availability is an essential data. Two inputs are required to develop the calculation:

- at least one point with available flow (mean annual discharge) data, otherwise a regionalization method can be applied [Alterach et al, 2005, 2006];
- water exploitation annual volumes with its precise location, i.e. withdrawal flows and restitutions flows along the analysed river stream.

It is possible to estimate the potential discharge to be used in a possible hydropower exploitation following computation and interpolation steps. The interpolation process uses a double transformation of the river flow data, first the “naturalization process” of the river measured point flows, interpolation of the natural values and then a final transformation of available flows for every cross section.

- evaluation of the Point Natural Flow (Q_{nat}) in a particular section, equals to the “Point Available Flow” (Q_{av}) , cancelling the effect of the upstream withdrawal/restitution scheme;
- estimation of the Natural Flow ($Q_{nat}(x)$) in every river section “x”, as a result of interpolations and proportions based on the Q_{nat} data;
- evaluation of the Available Flow ($Q_{av}(x)$), in every river section “x”, equals to the calculated Natural Flow minus the upstream withdrawal/restitution flows;
- calculation of the Hydropower Withdrawal Flow ($Q_{hp}(x)$) in every river cross section “x”, that represents the design value (mean annual discharge) for hydropower generation

plants. It takes into consideration also the downstream withdrawal/restitution flows and the Minimum Instream Flow.

The figure below shows the conceptual scheme followed to calculate the Hydropower Withdrawal Flow in a given cross section.

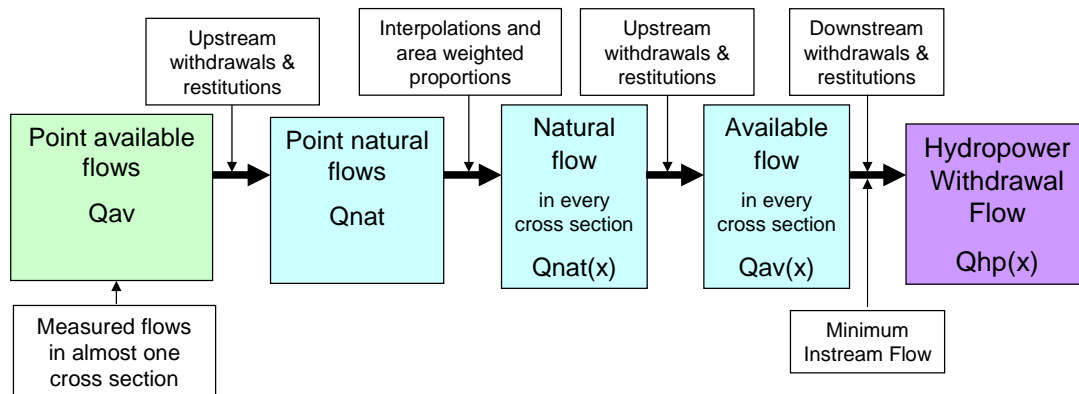

Figure 3.3.1. 1: Computation/interpolation process to calculate the hydropower withdrawal flow

The Q_{nat} for each measure point, is obtained summing the upstream withdrawal/restitution flows as in the following formula:

$$Q_{nat} = Q_{av} + \sum_{j=1}^N q_j$$

where:

- Q_{av} measured flow in the section (Point Anthropic Flow);
- Q_{nat} natural flow in the measuring section (Point Natural Flow);
- q_j withdrawal (+) or restitution (-) upstream points.

The figure below shows an schematic representation of the measure section (Available Flow) and the withdrawal/restitution upstream scheme:

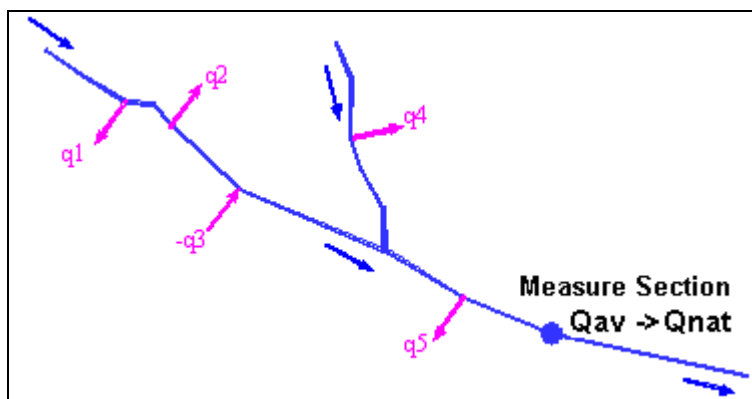

Figure 3.3.1. 2: Flow measure cross section and upstream withdrawal/restitution scheme

As a second step, $Q_{nat}(x)$ is calculated in every cross section “x”, using the area weighted interpolation (between two measured points) or a simple area weighted proportion (in case of

having only one measured point). For example, in picture below in branches B and C interpolation is applied, on the other hand the area weighted proportion is applied in branches A and D.

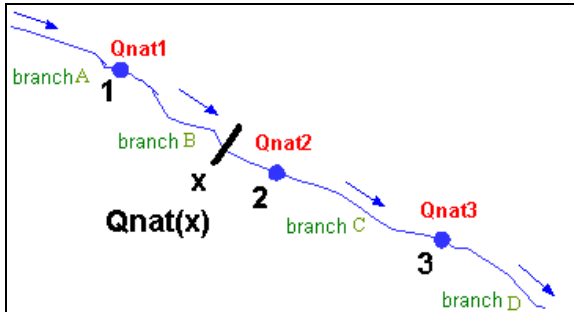

Figure 3.3.1. 3: Watercourse scheme with 3 flow measure sections

The third step concerns the evaluation of the available flow $Q_{av}(x)$ in every cross section, calculated as follows:

$$Q_{av}(x) = Q_{nat}(x) - \sum_{j=1}^N q_{xj}$$

where:

$Q_{av}(x)$ the available flow calculated in each cross section “x”;

$Q_{nat}(x)$ the natural flow calculated in the cross section x using the interpolation/proportion method;

q_{xj} withdrawal (+) or restitution (-) flow in the upstream j-sections, upstream of the “x” section.

The intake cross section of a hypothetical small hydro power plant must be designed for the available withdrawal mean annual flow. The method considers two constrains:

- the Minimum Instream Flow (MIF) calculated in the hypothetical intake section;
- the downstream withdrawals affected by the hypothetical small hydro itself (i.e. between the intake and the restitution points).

The figure below shows the hypothetical power plant, i.e. the intake point and the restitution point (from the powerhouse), and the withdrawals P1, P2 and P3 in the sections s1, s2 and s3, between them.

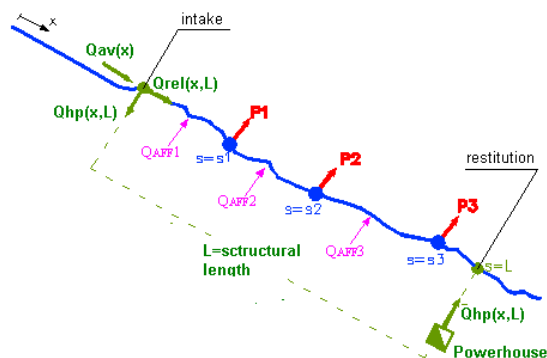

Figure 3.3.1. 4: Withdrawal scheme between the intake and restitution points

Let us define the *Maximum Withdrawal Flow* (Q_{\max}) in a given cross section “s” as the mean annual discharge that is possible to withdraw compatibly with the environmental constrains in the section “s”:

$$Q_{\max}(s) = Q_{av}(s) - MIF(s)$$

where Q_{av} represents the available flow in a cross section “s” as defined above and MIF is the Minimum Instream Flow considering river environmental quality, which can be assumed equal to the 10% of the natural flow in each cross section “s” [Regione Lombardia, 2006]:

$$MIF(s) = 0,1 \cdot Q_{nat}(s)$$

In order to calculate the *Hydropower Withdrawal Flow* (Q_{hp}) for each “x” cross section, one of the parameters that determine the potential hydropower production, it is necessary to refer to the critical section “s”, with the lowest Q_{\max} value in the “L” domain. The so called “structural length” (L) is defined as the distance between the intake and the restitution points, measured along the river thalweg.

The released discharge in the power plant cross section is the following:

$$Q_{rel}(x,L) = Q_{av}(x) - \min_{[s=0,L]} (Q_{\max}(s))$$

and the mean annual discharge that can be withdrawal for hydropower purposes is:

$$Q_{hp}(x,L) = \min_{[s=0,L]} (Q_{\max}(s))$$

It is possible to demonstrate that this methodology can ever satisfy the two constrains: the “Minimum Instream Flow” in the hypothetical intake section and the water availability at the downstream exploitation points.

3.3.1.1.2 Potential hydro power calculation

The Digital Elevation Model coupled with GIS tools, permits to obtain the ground elevation pattern and consequently the geodetic heads, related to a particular “structural length” (L), for any cross section “x” along the river stream. The geodetic head corresponds to the “Gross Head”, while the “Net Head” is obtained considering the hydraulic losses:

$$H_{net}(x,L) = H_{gross}(x,L) - \square H(L)$$

where:

$H_{gross}(x,L)$ Gross Head (m), depending on x and L;

$H_{net}(x,L)$ Net Head (m), depending on x and L;

$H(L)$ hydraulic losses in the channel and in the penstock, depending on L.

The most suitable river branches for the hydropower purposes consider the best couple [$H_{net}; Q_{hp}$]. Then the Maximum potential hydropower production is given from:

$$E(x,L) = \eta_T \cdot 9,81 \cdot Q_{hp}(x,L) \cdot H_{net}(x,L) \cdot 8760$$

where:

$E(x,L)$ yearly Maximum Available Energy (kWh/year), in function of x and L ;
 \square_T electric global efficiency;

The above mentioned energy is the maximum potential available, considering the total exploitation of Available Withdrawal Flow during the entire year (8760 hours), taking into consideration withdrawals and MIF.

To calculate the potential installable power, the following relation is used:

$$P(x, L) = E(x, L) / Kh$$

where

$P(x, L)$ is the installable power in a given section “ x ” for a structural length “ L ” (kW)

Kh yearly continuous hours at a maximum equivalent power to produce the potential energy (h/year)

3.3.1.1.3 Economic feasibility

The choice of the most appropriate sites for the hydropower exploitation depends upon the relationship between the construction and maintenance costs of the full system and the income from energy selling plus the additional grants, such as the Green Certificates. The economic parameters to be considered are the following:

- the hydropower plant cost (civil and electrical), for different structural lengths equal to 50, 100, 200, 500, 1000 and 2000 meters;
- the energy income
- the income/cost ratio.

The cost of each plant is evaluated by means of parametric relations as follows:

- cost of the powerhouse function of the installed power $P(x, L)$;
- cost of the penstock function of the pipe diameter and the structural length;
- cost of the weir and intake basin depending on the design flow;
- maintenance and exercise costs, proportional to the total work cost.

Therefore the cost can be expressed as follow:

$$C(x, L) = fn(L, P, Diam, Qhp)$$

On the other hand, the income is represented by the produced energy selling during the plant lifetime and the benefits of the Green Certificates for the first 12 years (Italy):

The formula that expresses the total updated income is:

$$I(x, L) = p \cdot E(x, L) \cdot \frac{(1+i)^n - 1}{i \cdot (1+i)^n} + pgc \cdot E(x, L) \cdot \frac{(1+i)^{n_{CV}} - 1}{i \cdot (1+i)^{n_{CV}}}$$

where

$I(x, L)$ total updated income (€);

- p energy selling price (€/kWh);
- E annual produced energy (kWh/year);
- i up-to-date interest (5%);
- n plant's lifetime, equals to 30 years;
- pgc Green Certificates price (€/kWh);
- nCV Green Certificates lifetime, 12 years.

The above mentioned formulas permit to calculate the Income/Cost ratio for every combination of intake sections “x” and structura lengths “L”.

The whole optimization process takes into account a chain of hydropower plants with different L and “x” (two freedom degrees optimization). The optimized configuration is obtained maximizing the energy production and the Income/Cost relation of the total chain.

3.3.1.1.4 The GIS software tool to evaluate the residual potential hydropower in a watercourse

The method illustrated in the above paragraphs is applied in a GIS integrated software (Vapidro-aste) to evaluate of the residual potential hydropower in a watercourse and aid to the optimization of the whole exploitation. The software is developed in Visual Basin language, integrated with ARCGIS 9 and it is now into a conclusion phase, with the testing over two studies areas in Italy: the Ogliolo River (Lombardia) and the Sinni river (Basilicata).



Figure 3.3.1. 5: VAPIDRO-ASTE start windows

The following paragraphs relate to some relevant working aspects of the software:

- River network, sub-basin and physiographic calculation parameters
- Discharge calculations and interpolations
- Residual potential Energy and Power profiles

- Results view
- Hydropower Optimization process

The Vapidro-aste tool is able to calculate automatically the river network associated to the interesting area. The user chose the interesting river branch, where to calculate the potential hydropower production, and then a series of chained sub-basins, are generated by the model. The following figure shows a vapidro-aste window containing the map of the Ogliolo river (Lombardia – Italy) with the sub-basin generated automatically:

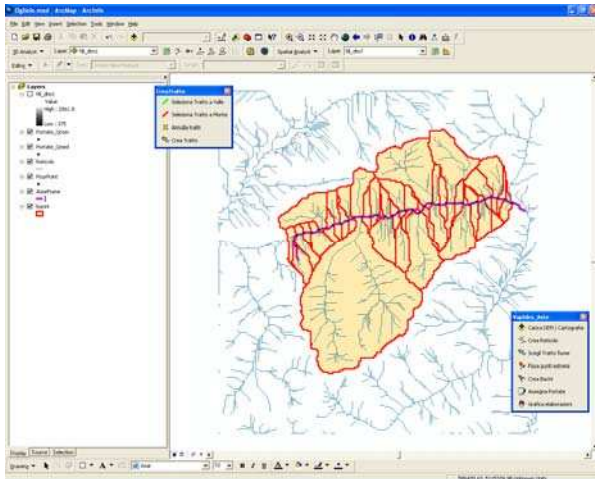

Figure 3.3.1.6: River network, sub-basin and main watercourse automatic computation

The main activities performed by the model are the following:

- Split of the Digital Elevation Model (DEM) regarding the interesting area.
- Automatic creation of the river network, by means of the Arcinfo Spatial Analyst functions
- Selection of the interest watercourse; by means upstream and downstream points user aided allocation
- Automatic creation of the sub-basins used for the interpolation (Figure 3.3.1.6).

Each basin is identified by its own closure point and the software calculates automatically the necessary data to perform the flow interpolation: progressive distances x , sub-basin areas, minimum elevation.

At this step, the user inputs the measured flows (Q_{av}) in one or more points over the selected watercourse.

The Software is able to calculate automatically the potential hydro energy and installed power for the selected watercourse, in a logarithmic scale.

As an example, the figure below shows the maximum installable power in the Ogliolo river, in Lombardia (Italy).

It is possible to observe that the software produces a set of energy and power curves which are parametric with the structural length L .

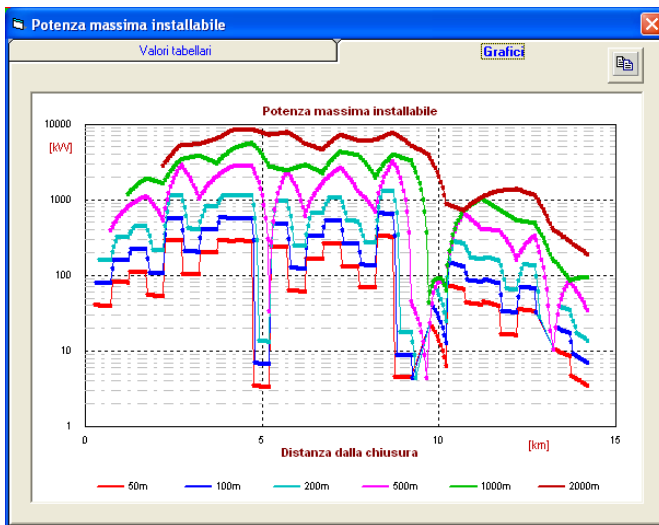

Figure 3.3.1.7: Installable hydropower along the watercourse

The tool is useful to represent the hydropower potential in a map, with a color spectrum, as shown in the figure below.

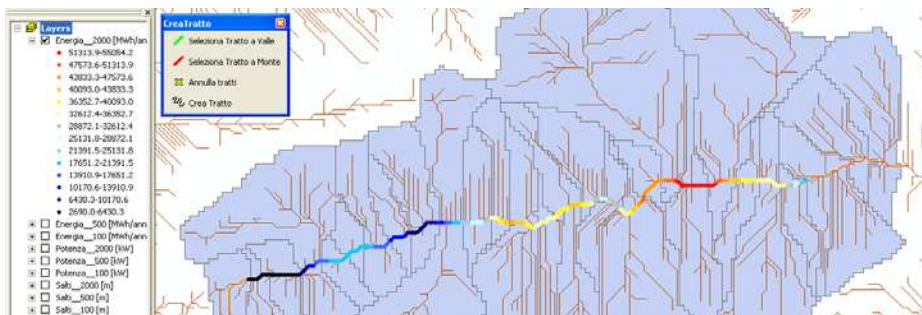

Figure 3.3.1.8: Potential Hydropower production in the Ogliolo River

The whole exploitation of the river is performed maximizing the total potential energy production and global Income/Cost ratio of the hydro plants exploitation chain. The figure below show seven optimized intakes position (squares), with the background of the benefit/cost ratio curves, in the Ogliolo River:

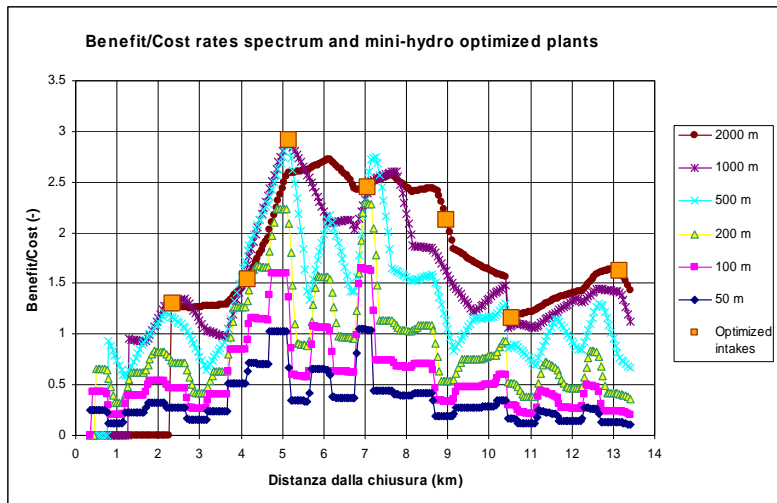

Figure 3.3.1.9: The income/cost spectrum and the optimal hydropower exploitation

Other way to represent the optimized position of the hydro plants is in a mapping way, laying intake (squares) and powerhouse locations:

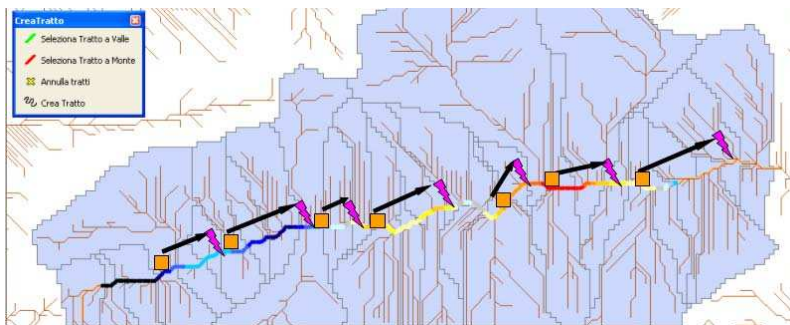

Figure 3.3.1.10: Watercourse optimal hydropower exploitation

An automatic optimization module is included, to produce the best hydropower exploitation scheme of plants, optimizing the financial parameters and the produced energy. The following figures shows an example of the automatic optimization module window:



Figure 3.3.1.11: Automatic optimization window

3.3.1.2 Smart Mini-Idro

Smart Mini Idro is a tool to evaluate the main hydropower project parameters, considering the flow duration curve, the available heads and the types of turbines to be installed, the range of discharges to be used, etc.

The tool considers the possibility to apply government incentives to the investment as the “green certificates” and finally is able to evaluate the cash-flow of the investment.

The tool helps the user as a first approach to begin a preliminary project, leading to a first analysis of the economical and financial parameters of a new SHP.

The software is composed by the following 5 modules:

- Discharge module, with the calculation of the Minimum Instream Flow, the turbined flows, etc)
- Turbine module, with the selection of the appropriate turbine type
- Energy module, with the calculation of the energy produced
- Costs module, with the evaluation of the construction and maintenance costs
- Financial Analysis module, with the calculation of the financial parameters and the cash flow analysis

The following figure shows the main SMART Mini Idro starting window:

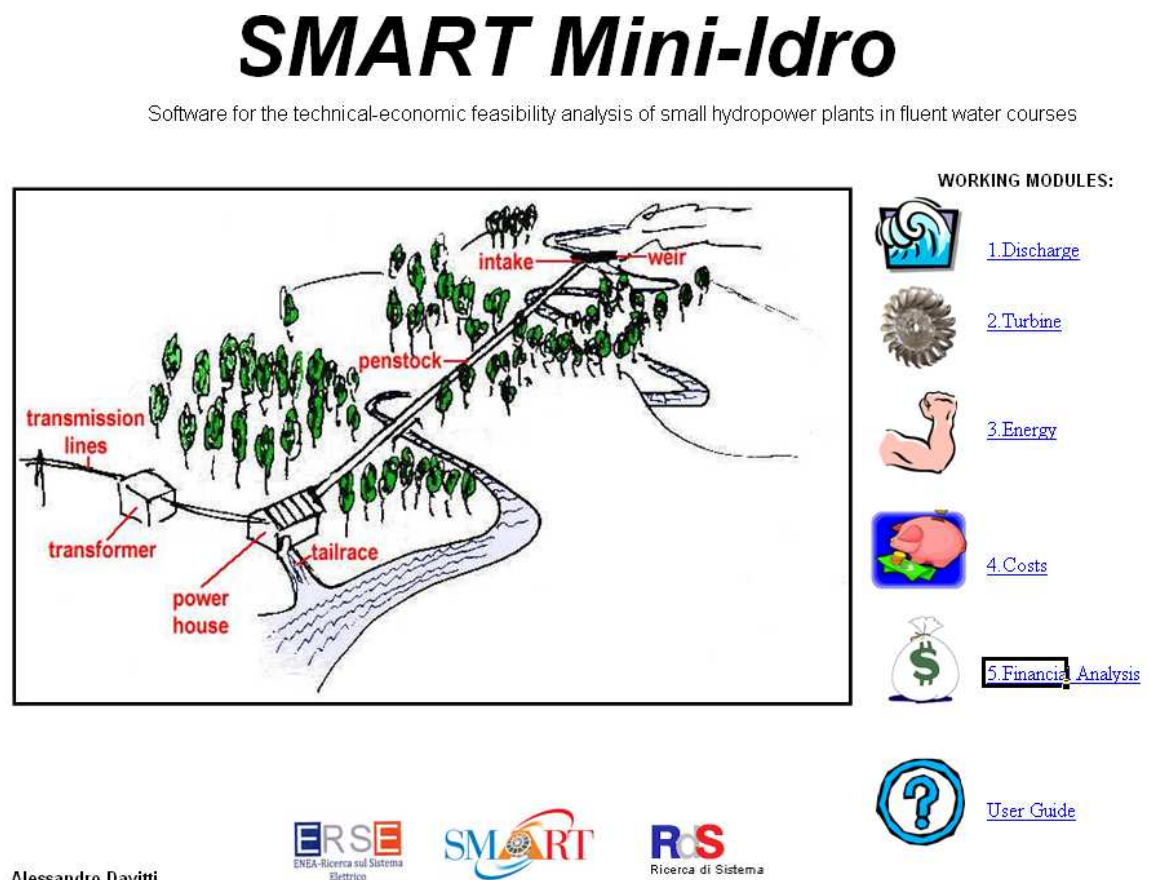

Figure 3.3.1.12: Main SMART Mini idro window

3.3.1.2.1 Discharge Module

The discharge module permits to define:

- The flow duration curve to be used in the project
- The MIF, minimum environmental flow to be assigned
- The hydropower discharge to be turbined

Flow duration curve

To introduce the Flow duration curve values, it is necessary to chose “Direct Input” and input the 21 flow values (from 0% o 100% durations). The values must be taken from hydrological statistical studies in the current river section.

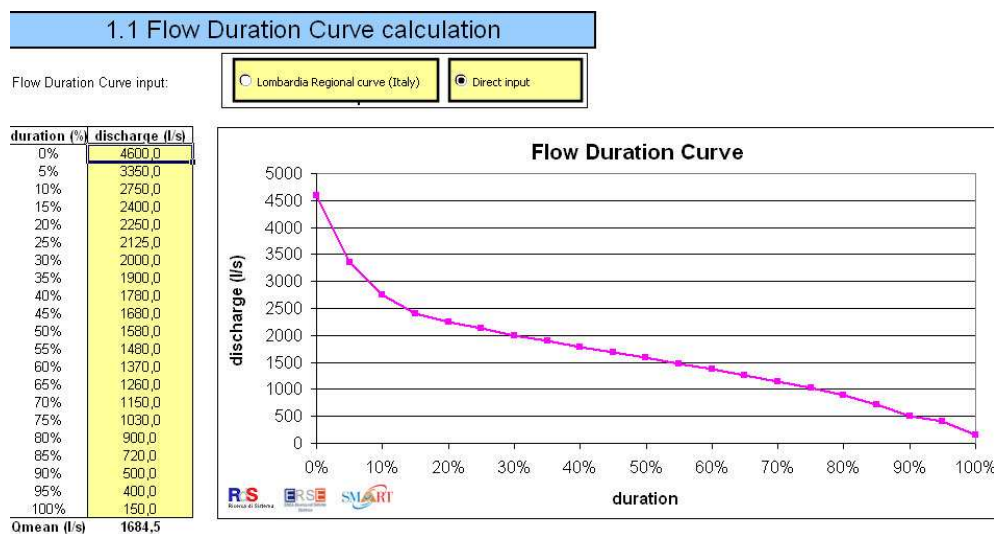

Figure 3.3.1.13: Flow duration curve input window

Minimum Instre

The Lombardia Region curve is valid only for the Northern Italy area and it is not useful for the pilot cases of the current project.

Minimum Environmental Flow definition

SMART Mini-Idro allows the input of the minimum environmental flow, MIF. It is defined as the minimum amount of water that must be ensured for the preservation of water bodies and aquatic biotic communities.

There are 3 ways to determine the MIF:

- Method of the Po River Basin Authority. Regarding the Italian Law n.7/2002
- Direct Input of the known value of the MIF
- Percentage Method: percentage of the average discharge calculated from the FDC (percentage of a Q mean)

1.2 Minimum Environmental Flow calculation (MIF)

MIF input:

italian low n. 7/02
 Direct Input
 percentage of Qmean

Value [%]
 MIF [l/s]

Figure 3.3.1.14: Minimum environmental flow input window

The most useful way to input the MIF is by the “percentage method”, taking into account the Flow duration Curve values assigned.

Calculation of the net discharges

For each duration, from 0% to 100%, the following discharges are calculated:

- Q gross: the total discharge, input in the FD;
- MIF: regards the value input in the MIF module;
- Q net: the net discharge, difference between the Q gross and the MIF.

The figure below illustrates the discharges values:

1.3 Net discharges calculation

duration(%)	Qgross(l/s)	MIF(l/s)	Qnet(l/s)
0%	4600.0	168.5	4431.5
5%	3350.0	168.5	3181.5
10%	2750.0	168.5	2581.5
15%	2400.0	168.5	2231.5
20%	2250.0	168.5	2081.5
25%	2125.0	168.5	1956.5
30%	2000.0	168.5	1831.5
35%	1900.0	168.5	1731.5
40%	1780.0	168.5	1611.5
45%	1680.0	168.5	1511.5
50%	1580.0	168.5	1411.5
55%	1480.0	168.5	1311.5
60%	1370.0	168.5	1201.5
65%	1260.0	168.5	1091.5
70%	1150.0	168.5	981.5
75%	1030.0	168.5	861.5
80%	900.0	168.5	731.5
85%	720.0	168.5	551.5
90%	500.0	168.5	331.5
95%	400.0	168.5	231.5
100%	150.0	150.0	0.0

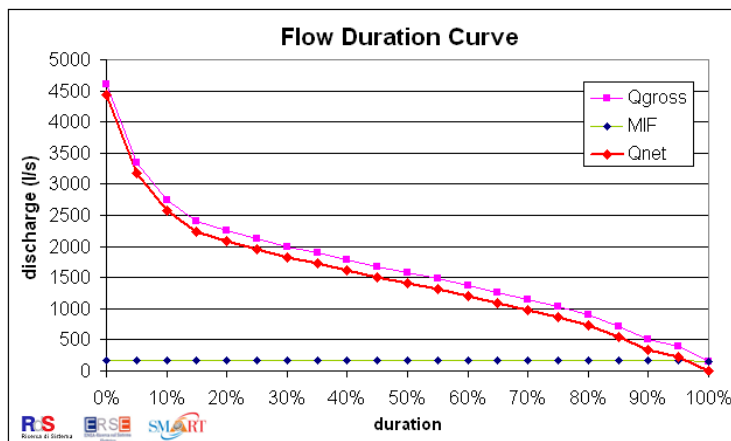

Figure 3.3.1.15: Net Discharges calculation windows

Hydropower discharge

The next step is to calculate the hydropower discharge to be turbined.

There are two methods to input the turbined discharge:

- Departing from the flow duration curve;
- Input of a Direct value.

The following figure shows the hydropower discharge window:

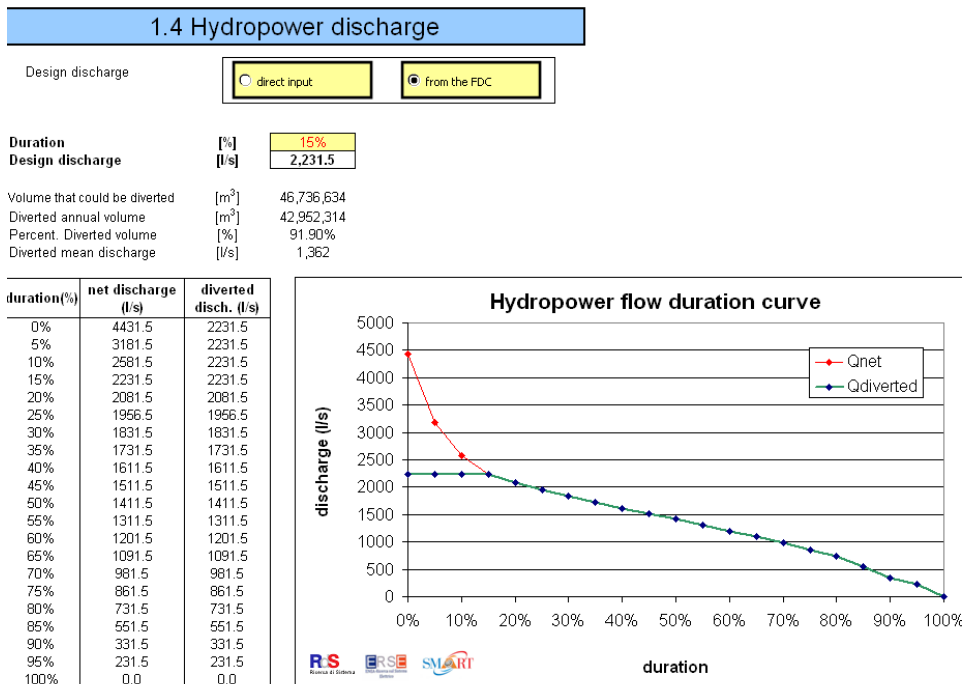

Figure 3.3.1.16: Hydropower discharge window

The most useful way to determine the design discharge is to assign a percentage of the Flow Duration Curve, for example 15% duration.

Utilization curves

SMART Mini Idro shows also two utilization curves of the project:

- The runoff utilization curve;
- The plant utilization curve.

The following figure shows the example:

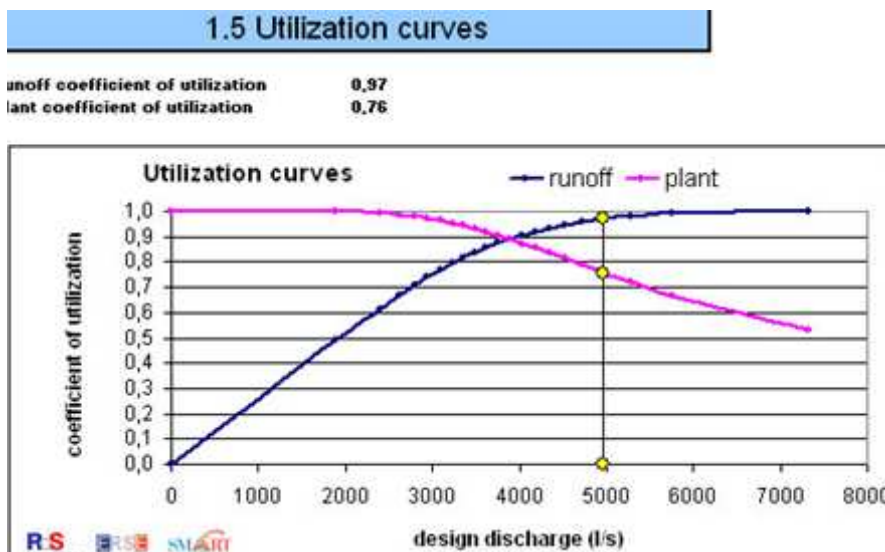

Figure 3.3.1.17: Utilization curves of the project

3.3.1.2.2 *Turbine selection Module*

The turbine selection module has two steps to follow:

- head, penstock length and hydraulic losses definition;
- selection of the turbine type.

Turbine – Net Head Calculation

The net head is estimated from the gross head considering the continuous and concentrated head losses:

- the continue head losses, are assessed through the characteristics of the penstock and the design speed;
- the concentrated losses, are defined as a fraction of the kinetic energy of the flow (α coefficient).

The following figure shows the window to introduce the needed values and the output screen:

2.1 Net head calculation

Design discharge	[l/s]	2231.5	
Gross head	[m]	100.00	

Penstock features:			
Penstock lenght	[m]	150.00	
Design speed in the penstock	[m/s]	5.00	
Strickler roughness	[m ^{1/3} /s]	80	
Penstock diameter	[m]	0.754	→
energy loss (adim)	[-]	0.026	→

maximum distributed loss	[m]	3.95	
maximum percentage loss	[%]	3.95%	
concentrated loss (= $\alpha * V^2/2g$)	[m]	0.50	$\alpha =$ 0.5
net head with design discharge	[m]	95.55	

Figure 3.3.1.18: Net Head calculation window

Turbine – Turbine selection

For each turbine it is proposed a typical turbine efficiency curve. It is also possible to assign manually the turbine efficiency curve.

SMART Mini Idro permits the selection of different types of turbines

- Pelton
- Turgo
- CrossFlow
- Francis
- Kaplan
- Others (user defined efficiency curve)

The following figure shows the window where to input the efficiency curve or the type of turbine.

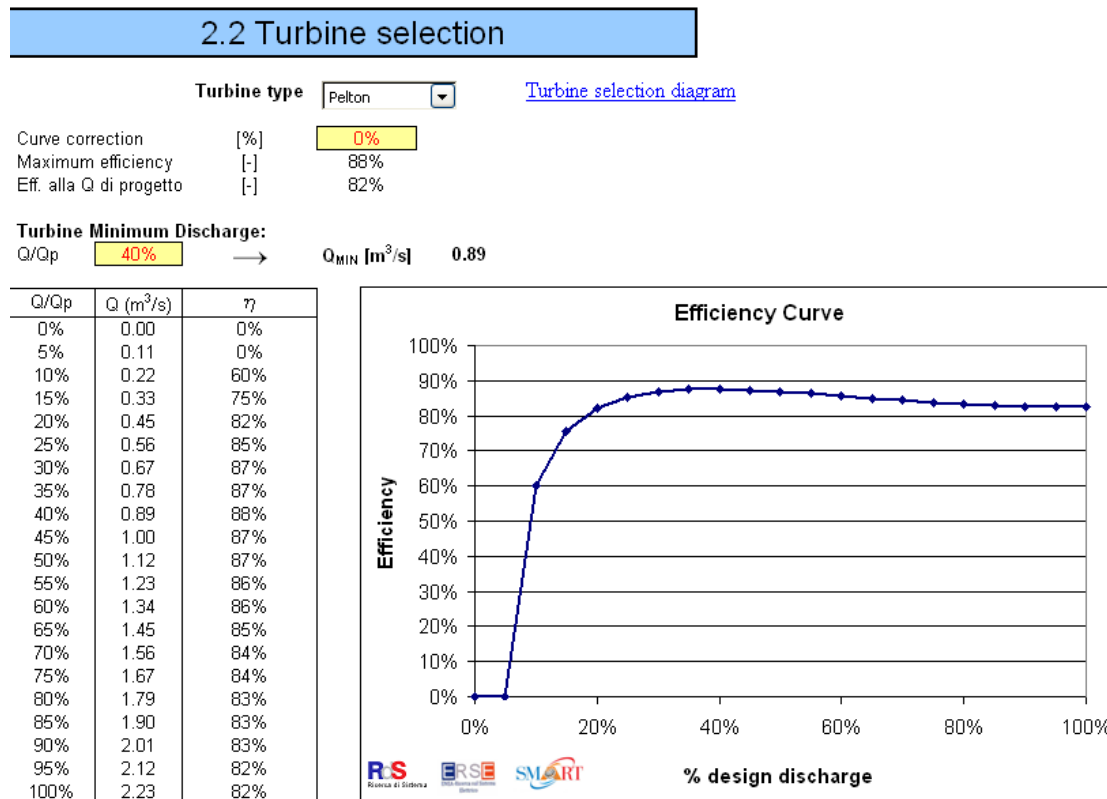

Figure 3.3.1.19: Turbine selection and efficiency curve

The turbine selection is function of the combination of the turbined discharge and the net head:

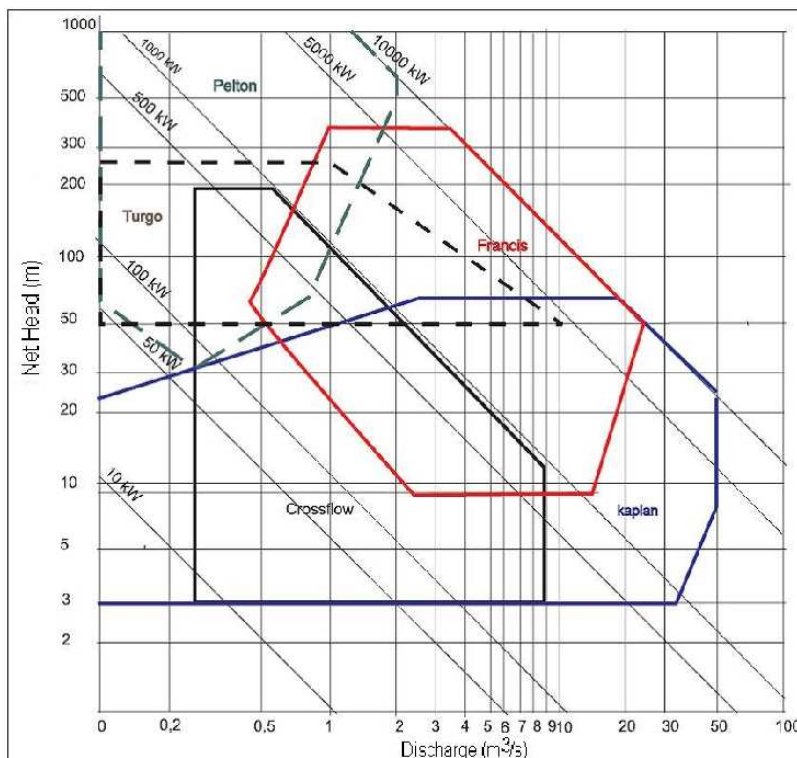

Figure 3.3.1.20: Turbine selection chart

3.3.1.2.3 Energy calculation Module

In this module it is possible to evaluate the *power plant* and estimate the *energy annual production*.

Characteristics of the plant

The Energy Module starts with the section "Characteristics of the plant," a brief summary of the data describing the plant: it is given the name, location, river, design discharge, gross head and type of turbine.

3.1 Characteristics of the plant		
Plant name		Progetto 1
Location		Italia
River		Fiume1
Design discharge	[Vs]	4.967,6
Gross head	[m]	100
Turbine type		Pelton

Figure 3.3.1.21: Characteristics of the plant

Power

This module needs some input data regarding the efficiency of each part of the machinery:

- Generator efficiency
- Transformer efficiency
- Gearbox efficiency

An additional input needed regards the percentage of stops of the turbines.

The power module is presented as in the next figure:

3.2 Power		
Turbine efficiency (Qdesign)	[%]	82%
Local losses	[m]	0.50
Maximum hydraulic loss	[%]	3.95%
Generator efficiency	[%]	97%
Transformer efficiency	[%]	98%
Gearbox efficiency	[%]	100%
Percentage of plant stop	[%]	5%
Maximum power	[kW]	1,724
Nominal power	[kW]	1,551
Average power	[kW]	1,120

Figure 3.3.1.22: Power calculation

The module uses the power calculation formula:

$$P(t) = \frac{1}{1000} \cdot \gamma \cdot Q_{DER}(t) \cdot H_n(Q_{DER}(t)) \cdot \eta_{TUR}(Q_{DER}(t))$$

Where

- P(t) is the power for each duration “t” in kW
- Qder(t) is the turbined discharge for each duration “t”
- H_n is the net head function of the Qder
- η_{TUR} total efficiency of the turbine
- γ specific weight of the water

Energy Annual Production

This module determines the power plant energy annual production.

$$P(t) = \frac{1}{1000} \cdot \gamma \cdot Q_{DER}(t) \cdot H_n(Q_{DER}(t)) \cdot \eta_{TUR}(Q_{DER}(t))$$

$$E_{ANNUA} [MWh] = \frac{1}{1000} \cdot \eta_{TOT} \cdot (1 - f) \cdot \int_0^{8760} P(t) \cdot dt$$

Where

- E_{ANNUA} is the annual energy produced
- η_{TOT} is the total efficiency used with the energy evaluation
- P(t) are the maximum power for each duration “t”

The following chart illustrates the flow and power duration curves,

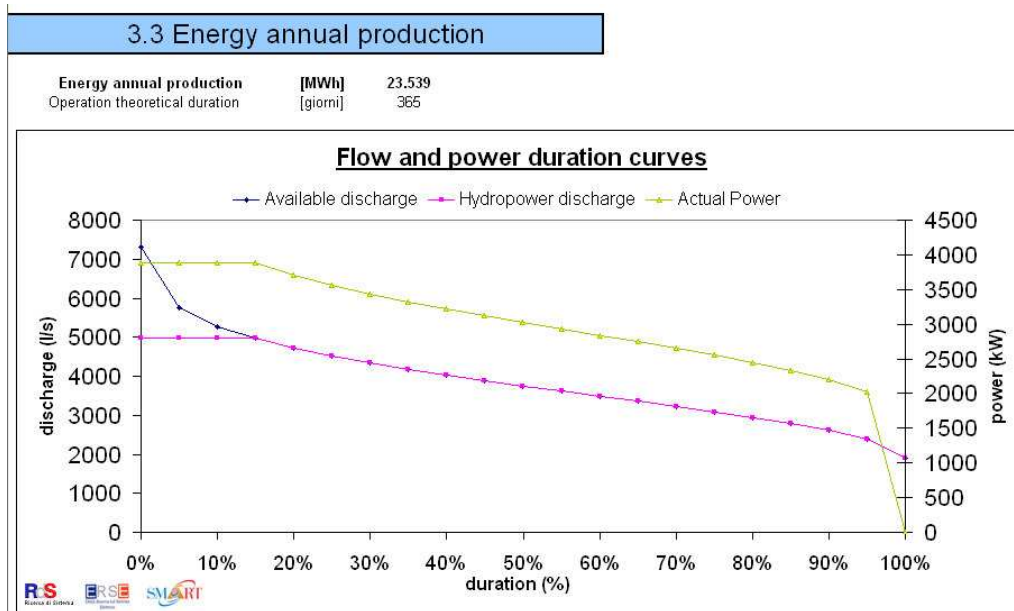

Figure 3.3.1.23: Flow and maximum power duration curves

3.3.1.2.4 Cost evaluation Module

Investment estimate

The Costs Module has only one section name “Investment estimate“: it aims to

estimate the cost required for the construction of the power plant in all its components.

Two ways are proposed by the tool:

- Synthetic estimate
- Correlation formulas

4.1 Investment estimate

Type of calculation:

Synthetic estimate
 Formulas

intake costs (maximum discharge function)			
$C_p(I) = a \cdot Q(m^3/s)^2 + b \cdot Q(m^3/s) + c$	a	0,000002	
	b	84238,00	
	c	81318,00	
	Q	4,97	[m ³ /s]
	C_p	499.775	[I]
Channel costs (maximum discharge and length function)			
$C_{ca}(I/m) = a \cdot Q(m^3/s)^2 + b \cdot Q(m^3/s) + c$	a	-2,52	
	b	65,16	
	c	254,26	
	Q	4,97	[m ³ /s]
	L	2000,00	[m]
C_{ca}	1.031.393	[I]	
Penstock costs (diameter and length function)			
$C_{cp}(I/m) = a \cdot D(m)^2 + b \cdot D(m) + c$	a	691,56	
	b	447,29	
	c	55,39	
	D	1,15	[m]
	L	150,00	[m]
C_{cp}	222.654	[I]	
Powerhouse costs (installed power function)			
$C_{ce}(I) = a \cdot P(kW)^2 + b \cdot P(kW) + c$	a	0,002400	
	b	782,52	
	c	261362,00	
	P	3491	[kW]
	C_{ce}	3.022.155	[I]
TOTAL COST (€)		4.775.978	

Total Plant cost	4.775.978	[I]
National contribution	0%	[%]
Capital Cost (I)	4.775.978	

Figure 3.3.1.24: Costs estimation parameters window

Formulas Option- in case the user does not have available the prices of the individual works, or does not know the characteristics of the installation, it is recommended to use the option “formulas” (with equations derived from practical cases).

3.3.1.2.5 Financial Analysis Module

The Financial Analysis module is simulating the cash flows for the life of a plant (30 years), with respect to the expenditures and the energy production of plant, elaborating and comparing the annual costs and benefits.

It is necessary to input the updated discount rate, the management & maintenance costs and the taxes & fees costs.

The next following figure illustrates the input window and the annual costs parameters needed:

5.1 Parameters

Financial parameters	
discount rate	0,05
project life (years)	30

5.2 Annual costs

management & maintenance	3%	[% of the investment cost]
manag. & maint. costs	79.587	[€/year]
taxes & fees	12,57	[€/kW/year]
taxes & fees costs	19.499	[€/year]
Annual costs	99.086	[€/year]

Figure 3.3.25: Annual costs parameters window

Annual benefit

In Italy the selling price of the energy and the incentive instruments are governed by the market, making it impossible to offer sale prices with equal validity in the future.

The designer must assign the most appropriate energy price per year of calculation.

It is possible to consider also the incomes from Green Certificates for an assigned period, for example 12 year.

The figure below shows the window to input the needed data:

5.3 Annual benefit

Energy price	0,07	[€/kWh]
Green certificates	SI	Green certificate price: 0,137 [€/kWh] for the first 12 years

Figure 3.3.1.26: Annual benefit input data window

Financial Analysis

The latest Financial Analysis section displays the cash flow and calculates the most representative economic indicators.

The figures below show the financial parameters calculated and the cash flow chart and the cumulative accumulated cash flow curve calculated.

5.4 Financial analysis

Net present value (NPV)	14,370,072	[€]
Updated performance index	5.42	[-]
Equal benefit cost updated per	1.80	[years]
Pay Back Period	2.91	[years]
Benefit - costs rate	4.44	[-]

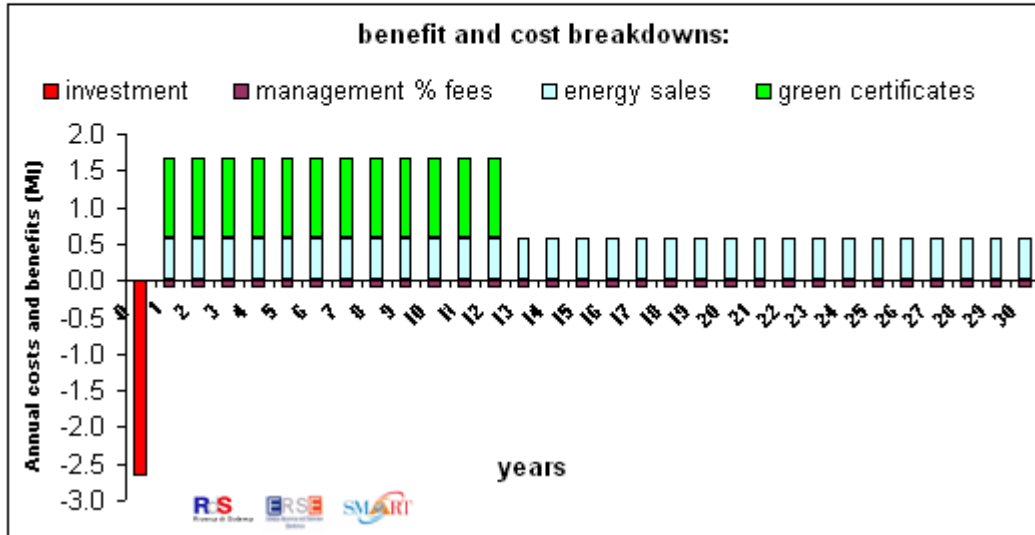

Figure 3.3.1.27: Financial analysis and cash flow

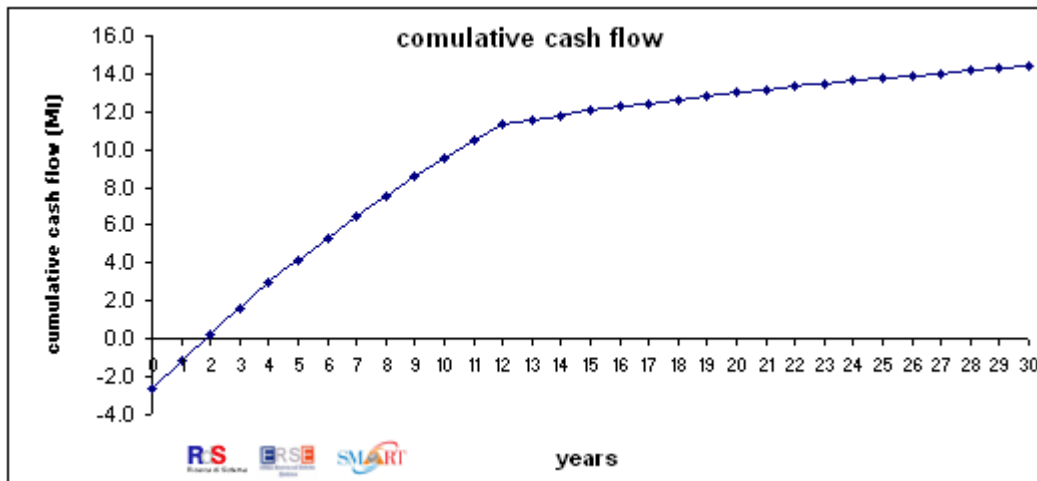

Figure 3.3.1.28: Cumulative cash flow

3.3.1.3 Hydropower Investor Database Structure

A GIS platform for the implementation of the Investor Database layout.

The user is able to zoom from national scale, to regional scale up to a County scale, to identify the installed power and quantities of minihydro installations.

In collaboration with each Province Administration, the database could be extended dynamically to represent also the asked concession in each zone.

The cadastre database is a useful tool that permits the stakeholders to evaluate the possibility to a new hydropower investment, and to know if this possibility is requested or not by other competitors.

3.3.1.3.1 Public Cadastre in the internet

It is an internet site structure with the information regarding mini hydro topics, links to the Hydropower Investors Database Structure, etc. to better disseminate opportunities to investors.